



POWER DIVIDERS AND COUPLERS, RF, COAXIAL

ESCC Generic Specification No. 3404

Issue 2	December 2015
---------	---------------



LEGAL DISCLAIMER AND COPYRIGHT

European Space Agency, Copyright © 2015. All rights reserved.

The European Space Agency disclaims any liability or responsibility, to any person or entity, with respect to any loss or damage caused, or alleged to be caused, directly or indirectly by the use and application of this ESCC publication.

This publication, without the prior permission of the European Space Agency and provided that it is not used for a commercial purpose, may be:

- copied in whole, in any medium, without alteration or modification.
- copied in part, in any medium, provided that the ESCC document identification, comprising the ESCC symbol, document number and document issue, is removed.

DOCUMENTATION CHANGE NOTICE

(Refer to <https://escies.org> for ESCC DCR content)

DCR No.	CHANGE DESCRIPTION
963	Specification upissued to incorporate editorial changes per DCR.

TABLE OF CONTENTS

1	GENERAL	8
1.1	SCOPE	8
1.2	APPLICABILITY	8
2	APPLICABLE DOCUMENTS	8
2.1	ESCC SPECIFICATIONS	8
2.2	OTHER (REFERENCE) DOCUMENTS	8
2.3	ORDER OF PRECEDENCE	9
3	TERMS, DEFINITIONS, ABBREVIATIONS, SYMBOLS AND UNITS	9
4	REQUIREMENTS	9
4.1	GENERAL	9
4.1.1	Specifications	9
4.1.2	Conditions and Methods of Test	9
4.1.3	Manufacturer's Responsibility for Performance of Tests and Inspections	9
4.1.4	Inspection Rights	9
4.1.5	Internal Visual Inspection	10
4.2	QUALIFICATION APPROVAL REQUIREMENTS ON A MANUFACTURER	10
4.3	DELIVERABLE COMPONENTS	10
4.3.1	Lot Failure	10
4.3.2	Testing and Lot Acceptance Levels	11
4.4	MARKING	11
4.5	MATERIALS AND FINISHES	11
5	PRODUCTION CONTROL	11
5.1	GENERAL	11
5.2	SPECIAL IN-PROCESS CONTROLS	11
6	FINAL PRODUCTION TESTS	13
6.1	GENERAL	13
6.2	TEST METHODS AND CONDITIONS	13
6.3	DOCUMENTATION	13
7	BURN-IN AND ELECTRICAL MEASUREMENTS	13
7.1	GENERAL	13
7.1.1	Conditions of Test	13
7.1.2	Data Points	13
7.2	FAILURE CRITERIA	14
7.2.1	Parameter Drift Failure	14
7.2.2	Parameter Limit Failure	14

7.2.3	Other Failures	14
7.3	FAILED COMPONENTS	14
7.4	LOT FAILURE	14
7.4.1	Lot Failure during 100% Testing	14
7.4.2	Lot Failure during Sample Testing	14
7.5	DOCUMENTATION	14
8	QUALIFICATION APPROVAL AND LOT ACCEPTANCE TESTS	15
8.1	QUALIFICATION TESTING	15
8.1.1	General	15
8.1.2	Distribution within the Qualification Test Lot	15
8.2	LOT ACCEPTANCE TESTING	15
8.2.1	General	15
8.2.2	Distribution within the Sample for Lot Acceptance Testing	15
8.2.3	Lot Acceptance Level 3 Testing (LA3)	16
8.2.4	Lot Acceptance Level 2 Testing (LA2)	16
8.2.5	Lot Acceptance Level 1 Testing (LA1)	16
8.3	FAILURE CRITERIA	16
8.3.1	Environmental and Mechanical Test Failures	16
8.3.2	Electrical Failures	17
8.3.3	Other Failures	17
8.4	FAILED COMPONENTS	17
8.5	LOT FAILURE	17
8.6	DOCUMENTATION	17
9	TEST METHODS AND PROCEDURES	22
9.1	INTERNAL VISUAL INSPECTION	22
9.2	THERMAL CYCLING	22
9.3	VIBRATION CYCLING	22
9.4	EXTERNAL VISUAL INSPECTION	22
9.5	ELECTRICAL MEASUREMENTS	22
9.5.1	General	22
9.5.1.1	Couplers	22
9.5.1.2	Power Dividers	24
9.5.2	Parameter Drift Value Measurements	26
9.5.3	Electrical Measurements at High and Low Temperatures	26
9.5.4	Electrical Measurements at Room Temperature	26
9.5.5	Electrical Measurements during Endurance Testing	26

9.6	FEMALE CONTACT RETENTION	26
9.7	VIBRATION	26
9.7.1	Mounting	26
9.7.2	Procedure	26
9.7.3	Measurement during Vibration	26
9.7.4	Visual Inspection	27
9.8	SHOCK OR BUMP	27
9.8.1	Shock	27
9.8.1.1	Mounting	27
9.8.1.2	Procedure	27
9.8.1.3	Visual Inspection and Electrical Measurements	27
9.8.2	Bump	27
9.8.2.1	Mounting	27
9.8.2.2	Procedure	27
9.8.2.3	Visual Inspection and Electrical Measurements	27
9.9	RAPID CHANGE OF TEMPERATURE	28
9.9.1	Initial Measurement	28
9.9.2	Procedure	28
9.9.3	Recovery and Final Measurement	28
9.10	CLIMATIC SEQUENCE	28
9.10.1	Initial Measurements	28
9.10.2	Dry Heat	28
9.10.3	Damp Heat, Accelerated, First Cycle	28
9.10.4	Cold Test	28
9.10.5	Low Air Pressure	28
9.10.6	Damp Heat, Accelerated, Remaining Cycles	29
9.10.7	Final Measurements	29
9.11	CORROSION	29
9.12	OPERATING LIFE	29
9.12.1	Initial Measurements	29
9.12.2	Mounting	29
9.12.3	Procedure	29
9.12.4	Final Measurements	29
9.13	RF LEAKAGE	30
9.14	POWER LEVEL	30
9.15	HIGH TEMPERATURE STORAGE	31

9.15.1	Initial Measurement	31
9.15.2	Procedure	31
9.15.3	Final Measurements	31
9.16	PEAK POWER	31
9.17	PERMANENCE OF MARKING	31
9.18	DIMENSION CHECK	31
9.19	WEIGHT	31
10	DATA DOCUMENTATION	32
10.1	GENERAL	32
10.1.1	Qualification Approval	32
10.1.2	Testing Level "B"	32
10.1.2.1	Qualified Components	32
10.1.2.2	Unqualified Components	32
10.1.3	Data Retention/Data Access	32
10.2	COVER SHEET(S)	33
10.3	LIST OF EQUIPMENT USED	33
10.4	LIST OF TEST REFERENCES	33
10.5	SPECIAL IN-PROCESS CONTROL DATA	33
10.6	FINAL PRODUCTION TEST DATA (CHART II)	33
10.7	BURN-IN AND ELECTRICAL MEASUREMENT DATA (CHART III)	34
10.7.1	Testing Level "B"	34
10.7.2	Testing Level "C"	34
10.8	Q UALIFICATION TEST DATA (CHART IV)	34
10.9	LOT ACCEPTANCE TEST DATA (CHART V)	34
10.9.1	Testing Level "B"	34
10.9.2	Testing Level "C"	34
10.10	FAILED COMPONENTS LIST AND FAILURE ANALYSIS REPORT	34
10.11	CERTIFICATE OF CONFORMITY	34
11	DELIVERY	35
12	PACKAGING AND DESPATCH	35

1 GENERAL

1.1 SCOPE

This specification defines the general requirements for the qualification approval, procurement, including lot acceptance testing, and delivery of RF Coaxial Power Dividers and Couplers, for space application. It contains the appropriate inspection and test schedules and also specifies the data documentation requirements.

1.2 APPLICABILITY

This specification is primarily applicable to the granting of qualification approval to a component in accordance with ESCC Basic Specification No. 20100 and the procurement of such components from qualified Manufacturers.

2 APPLICABLE DOCUMENTS

The following documents form part of, and shall be read in conjunction with, this specification. The relevant issues shall be those in effect on the date of placing the purchase order.

2.1 ESCC SPECIFICATIONS

- No. 20100, Requirements for the Qualification of Standard Electronic Components for Space Application.
- No. 20400, Internal Visual Inspection.
- No. 20500, External Visual Inspection.
- No. 20600, Preservation, Packaging and Despatch of ESCC Electronic Components.
- No. 21300, Terms, Definitions, Abbreviations, Symbols and Units.
- No. 21700, General Requirements for the Marking of ESCC Components.
- No. 22800, ESCC Non-conformance Control System.
- No. 24600, Minimum Quality System Requirements.
- No. 24800, Resistance to Solvents of Marking, Materials and Finishes.
- No. 3402, Connectors, RF, Coaxial.

With the exception of ESCC Basic Specifications Nos. 20100, 21700, 22800 and 24600, where Manufacturers' specifications are equivalent to, or more stringent than, the ESCC Basic Specifications listed above, they may be used in place of the latter, subject to the approval of the ESCC Executive.

Such replacements shall be clearly identified in the applicable Process Identification Document (PID) and listed in an Appendix to the appropriate Detail Specification.

Unless otherwise stated herein, references within the text of this specification to "the Detail Specification" shall mean the relevant ESCC Detail Specification.

2.2 OTHER (REFERENCE) DOCUMENTS

- IEC Publication No. 68, Basic Environmental Testing Procedures.
- IEC Publication No. 410, Sampling Plans and Procedures for Inspection by Attributes.
- ECSS-Q-ST-70-02, A Thermal Vacuum Test for the Screening of Space Materials.

2.3 ORDER OF PRECEDENCE

For the purpose of interpretation and in case of conflict with regard to documentation, the following order of precedence shall apply:

- (a) ESCC Detail Specification.
- (b) ESCC Generic Specification.
- (c) ESCC Basic Specification.
- (d) Other documents, if referenced herein.

3 TERMS, DEFINITIONS, ABBREVIATIONS, SYMBOLS AND UNITS

The terms, definitions, abbreviations, symbols and units specified in ESCC Basic Specification No. 21300 shall apply.

4 REQUIREMENTS

4.1 GENERAL

The test requirements for qualification approval of a component shall comprise final production tests (see Chart II), burn-in and electrical measurements to testing level "B" (see Chart III) and qualification testing (see Chart IV).

The test requirements for procurement of components shall comprise final production tests (Chart II), burn-in and electrical measurements to testing level "B" (Chart III) together with, when applicable, a level of lot acceptance testing (see Chart V) to be specified by the Orderer.

If a Manufacturer elects to eliminate a final production test by substituting an in-process control or statistical process control procedure, the Manufacturer is still responsible for delivering components that meet all of the performance, quality and reliability requirements defined in this specification and the Detail Specification.

4.1.1 Specifications

For qualification approval, procurement (including lot acceptance testing) and delivery of components in conformity with this specification, the specifications listed in Section 2 of this document shall apply in total unless otherwise specified herein or in the Detail Specification.

4.1.2 Conditions and Methods of Test

The conditions and methods of test shall be in accordance with this specification, the ESCC Basic Specifications referenced herein and the Detail Specification.

4.1.3 Manufacturer's Responsibility for Performance of Tests and Inspections

The Manufacturer shall be responsible for the performance of tests and inspections required by the applicable specifications. These tests and inspections shall be performed at the plant of the Manufacturer of the components unless it is agreed by the ESCC Executive prior to commencing qualification testing, or procurement, to use an approved external facility.

4.1.4 Inspection Rights

The ESCC Executive reserves the right to monitor any of the tests and inspections scheduled in the applicable specifications.

4.1.5 Internal Visual Inspection

The Manufacturer shall notify the Orderer at least 2 working weeks before the commencement of internal visual inspection. The Orderer shall indicate immediately whether or not he intends to witness the inspection.

4.2 QUALIFICATION APPROVAL REQUIREMENTS ON A MANUFACTURER

To obtain and maintain the qualification approval of a component, or family of components, a Manufacturer shall satisfy the requirements of ESCC Basic Specification No. 20100.

4.3 DELIVERABLE COMPONENTS

Components delivered to this specification shall be processed and inspected in accordance with the relevant Process Identification Document (PID). Each delivered component shall be traceable to its production lot. Components delivered to this specification shall have completed satisfactorily all tests to the testing level and lot acceptance level specified in the purchase order (see Para. 4.3.2).

ESCC qualified components delivered to this specification shall be produced from lots that are capable of passing all tests, and sequences of tests, that are defined in Charts IV and V. The Manufacturer shall not knowingly supply components that cannot meet this requirement. In the event that, subsequent to delivery and prior to operational use, a component is found to be in a condition such that it could not have passed these tests at the time of manufacture, this shall be grounds for rejection of the delivered lot.

4.3.1 Lot Failure

Lot failure may occur during final production tests (Chart II), burn-in and electrical measurements (Chart III), qualification testing (Chart IV) or lot acceptance testing (Chart V).

Should such failure occur, the non-conformance procedure shall be initiated in accordance with ESCC Basic Specification No. 22800.

Should such failure occur during procurement, the Manufacturer shall notify the Orderer by any appropriate written means within 2 working days, giving details of the number and mode of failure and the suspected cause.

In the case where qualification approval has been granted to the component, he shall, at the same time by the same means, inform the ESCC Executive in order that the latter may consider its implications.

No further testing shall be performed on the failed components except on instruction from the Orderer. The Orderer shall inform the Manufacturer and the ESCC Executive within 2 working days of receipt of the communication, by the same means, what action shall be taken.

In the case when lot failure occurs during qualification testing, the Manufacturer shall immediately notify the ESCC Executive who will define a course of action to be followed. No further testing shall be performed on the failed components.

4.3.2 Testing and Lot Acceptance Levels

This specification defines 1 level of testing severity which is designated by the letter "B" (see Chart I) and 3 levels of lot acceptance testing (see Chart V).

The lot acceptance levels are designated 1, 2 and 3 and are comprised of tests as follows:

Level 3 (LA3) - Dimensional Subgroup.

Level 2 (LA2) - Endurance Subgroup
plus Dimensional Subgroup.

Level 1 (LA1) - Environmental and Mechanical Subgroup
plus Endurance Subgroup
plus Dimensional Subgroup.

The required testing level and lot acceptance level shall both be specified in a purchase order.

4.4 MARKING

All components procured and delivered to this specification from a source qualified according to ESCC Basic Specification No. 20100 shall be marked in accordance with ESCC Basic Specification No. 21700. Thus, they shall bear the ESA symbol to signify their conformance to the ESCC qualification approval requirements and full compliance with the requirements of this specification and the Detail Specification.

Components procured from sources which are not ESCC qualified, provided that they fully comply with the procurement requirements of this specification and the Detail Specification, may bear the ESCC marking **with the exception of the ESA symbol.**

4.5 MATERIALS AND FINISHES

All non-metallic materials and finishes that are not within a hermetically sealed enclosure, of the components specified herein shall meet the outgassing requirements as outlined in ECSS-Q-ST-70-02.

Specific requirements for materials and finishes are specified in the Detail Specification.

5 PRODUCTION CONTROL

5.1 GENERAL

The minimum requirements for production control, which are equally applicable to procurement, are defined in ESCC Basic Specification No. 20100, Paras. 5.1 and 5.2.

5.2 SPECIAL IN-PROCESS CONTROLS

Where applicable, special in-process controls shall apply as specified in the Detail Specification.

CHART I - TESTING LEVELS

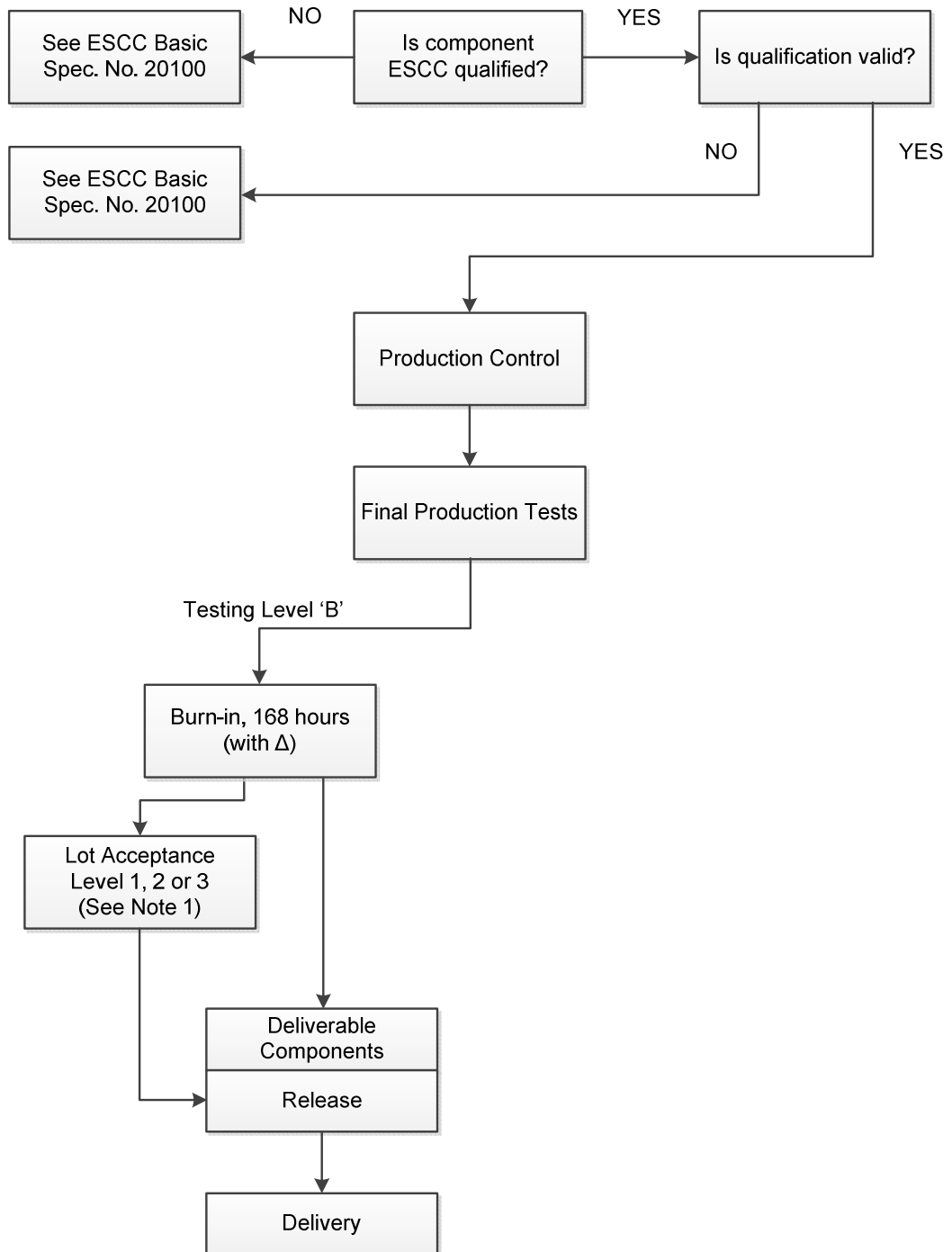

NOTES

1. When applicable.

6 FINAL PRODUCTION TESTS

6.1 GENERAL

Unless otherwise specified in the Detail Specification, all components used for qualification testing and all components for delivery, including those submitted to lot acceptance tests, shall be subjected to tests and inspections in accordance with Chart II.

Unless otherwise specified in the Detail Specification, the tests shall be performed in the order shown.

Any components that do not meet these requirements shall be removed from the lot and at no future time be re-submitted to the requirements of this specification.

6.2 TEST METHODS AND CONDITIONS

The applicable test methods and conditions are specified in the paragraphs referenced in Chart II of this specification.

6.3 DOCUMENTATION

Documentation of final production test data shall be in accordance with the requirements of Para. 10.6 of this specification.

7 BURN-IN AND ELECTRICAL MEASUREMENTS

7.1 GENERAL

Unless otherwise specified in the Detail Specification, all components used for qualification testing and all components for delivery, including those submitted to lot acceptance tests, shall be subjected to tests and inspections in accordance with Chart III.

Unless otherwise specified in the Detail Specification, the tests shall be performed in the order shown.

The applicable test methods and conditions are specified in the paragraphs referenced in Chart III.

Components of testing level "B" shall be serialised prior to the tests and inspections.

7.1.1 Conditions of Test

The conditions for burn-in shall be as shown in Table 5 of the Detail Specification.

Unless otherwise specified in the Detail Specification, components of level "B" shall be-subjected to a total burn-in period of 168 hours.

7.1.2 Data Points

For components of testing level "B", undergoing a total burn-in period of 168 hours, the data points for parameter drift measurement shall be 0 hours (initial) and 168 (+24 -0) hours (final).

7.2 FAILURE CRITERIA

7.2.1 Parameter Drift Failure

The acceptable delta limits are shown in Table 4 of the Detail Specification. A component of testing level "B" shall be counted as a parameter drift failure if the changes during burn-in are larger than the delta (Δ) values specified

7.2.2 Parameter Limit Failure

A component shall be counted as a limit failure if one or more parameters exceed the limits shown in Tables 2 or 3 of the Detail Specification.

Any component which exhibits a limit failure prior to the burn-in sequence shall be rejected and not counted when determining lot rejection.

7.2.3 Other Failures

A component shall be counted as a failure in any of the following cases:

- Mechanical failure.
- Handling failure.
- Lost component.

7.3 FAILED COMPONENTS

A component shall be considered as a failed component if it exhibits one or more of the failure modes described in Para. 7.2 of this specification.

7.4 LOT FAILURE

In case of lot failure, the Manufacturer shall act in accordance with the requirements of Para. 4.3.1 of this specification.

7.4.1 Lot Failure during 100% Testing

If the number of components failed on the basis of the failure criteria described in Para. 7.2 is:

- 2 devices of a lot of between 5 and 20 components
- 1 device of a lot equal to, or smaller than, 5 components

the lot shall be considered as failed. A lot is composed of groups of components of the same technology as defined in the Detail Specification.

7.4.2 Lot Failure during Sample Testing

A lot shall be considered as failed if the number of allowable failures during sample testing, in accordance with General Inspection Level II of IEC Publication No. 410 and the applicable AQL, as specified in the Detail Specification, is exceeded.

If a lot failure occurs, a 100% testing may be performed with the lot failure criteria given in Para. 7.4.1.

7.5 DOCUMENTATION

Data documentation of burn-in and electrical measurements shall be in accordance with Para. 10.7.

8 QUALIFICATION APPROVAL AND LOT ACCEPTANCE TESTS

8.1 QUALIFICATION TESTING

8.1.1 General

Qualification testing shall be in accordance with the requirements of Chart IV of this specification. The tests to Chart IV shall be performed on the specified sample, chosen at random from components which have successfully passed the tests in Charts II and III for testing level "B". This sample constitutes the qualification test lot.

The qualification test lot is divided into subgroups of tests and all components assigned to a subgroup shall be subjected to all of the tests in that subgroup, in the sequence shown.

The applicable test requirements are detailed in the paragraphs referenced in Chart IV.

The conditions governing qualification testing are given in ESCC Basic Specification No. 20100, Para. 5.3 and, for the extension or renewal of qualification approval, in Paras. 6.3 and 6.4.

8.1.2 Distribution within the Qualification Test Lot

Where a Detail Specification covers a range, or series of components that are considered similar, then the qualification test lot shall be comprised of component types so selected that they adequately represent all of the various mechanical, structural and electrical peculiarities of that range or series.

The distribution shall be as specified by, or agreed with, the ESCC Executive.

8.2 LOT ACCEPTANCE TESTING

8.2.1 General

The sample sizes of the 3 lot acceptance levels are specified in Chart V. All components assigned to a subgroup shall be subjected to all of the tests of that subgroup in the sequence shown.

The tests to Chart V shall be performed on the specified sample which shall have been chosen, whenever possible, at random from the proposed delivery lot (but see Para. 8.2.3(b)).

The applicable test requirements are detailed in the paragraphs referenced in Chart V.

As a minimum for procurement of non-qualified components, lot acceptance level 3 tests shall apply. For procurement of qualified components, lot acceptance testing shall be performed if specified in a purchase order. Procurement lots ordered with a lot acceptance test level shall be delivered only after successful completion of lot acceptance testing.

8.2.2 Distribution within the Sample for Lot Acceptance Testing

Where a Detail Specification covers a range or series of components that are considered similar, then it may be necessary that the sample for lot acceptance testing be comprised of component types so selected that they adequately represent all of the various mechanical, structural and electrical peculiarities of the procured range or series.

The distribution of the component types will normally vary from procurement to procurement and shall be as specified by the Orderer, following as closely as possible the requirements prescribed in Para. 8.1.2 of this specification.

8.2.3 Lot Acceptance Level 3 Testing (LA3)

Lot acceptance level 3 tests are designated as the dimensional subgroup and comprise tests to prove the assembly capability of the component. For LA3 testing, the following requirements and conditions shall apply:

- (a) LA3 testing shall be performed by the Manufacturer's quality assurance personnel using dedicated quality assurance equipment whenever possible. LA3 testing shall not be a repetition of routine measurements made by production personnel during final production tests and burn-in and electrical measurements.
- (b) The tests for LA3 are considered to be non-destructive and therefore components so tested may form part of the delivery lot.
- (c) When required in the purchase order, the Manufacturer shall notify the Orderer at least 2 working weeks before the commencement of LA3 testing. The Orderer shall indicate immediately whether or not he intends to witness the tests.

8.2.4 Lot Acceptance Level 2 Testing (LA2)

Lot acceptance level 2 testing shall comprise the tests for LA3 (dimensional subgroup) plus tests on an endurance subgroup. For the dimensional subgroup, the requirements and conditions as for LA3 (see Para. 8.2.3) shall apply.

For the endurance subgroup, the following shall apply:

- (a) The tests in this subgroup are considered to be destructive and therefore components so tested shall not form part of the delivery lot.

8.2.5 Lot Acceptance Level 1 Testing (LA1)

Lot acceptance level 1 testing shall comprise the tests for LA3 (dimensional subgroup) and LA2 (endurance subgroup) plus tests on an environmental and mechanical subgroup. For the dimensional and endurance subgroups, the requirements and conditions for LA3 (see Para. 8.2.3) and LA2 (see Para. 8.2.4) respectively shall apply.

For the environmental subgroup, the following shall apply:

- (a) The tests in this subgroup are considered to be destructive and therefore components so tested shall not form part of the delivery lot.

8.3 FAILURE CRITERIA

The following criteria shall apply to qualification testing and to lot acceptance testing.

8.3.1 Environmental and Mechanical Test Failures

The following shall be counted as component failures:

- Components which fail during tests for which the pass/fail criteria are inherent in the test method, e.g. Corrosion.

8.3.2 Electrical Failures

The following shall be counted as component failures:

- Components which, when subjected to electrical measurements on completion of environmental tests, in accordance with either Table 2 or Table 6, as specified in the Detail Specification, fail one or more of the applicable limits.
- Components which, when subjected to electrical measurements at intermediate and end-points during endurance testing, in accordance with Table 6 of the Detail Specification, fail one or more of the applicable limits.
- Components which, when subjected to measurement of electrical characteristics, in accordance with Tables 2 and 3 of the Detail Specification, fail one or more of the applicable limits.

8.3.3 Other Failures

The following additional failures may also occur during qualification testing or lot acceptance testing:

- Components failing to comply with the requirements of ESCC Basic Specification No. 20500.
- Lost components.

8.4 FAILED COMPONENTS

A component shall be considered as failed if it exhibits one or more of the failure modes detailed in Para. 8.3 of this specification. The allowable number of failed components per subgroup, the aggregate failure constraints and the permitted distribution of such failures are shown at the foot of Charts IV and V of this specification.

When requested by the ESCC Executive or the Orderer, failure analysis of failed components shall be performed by the Manufacturer and the results provided.

Failed components from successful lots shall be marked as such and be stored at the Manufacturer's plant for 24 months.

8.5 LOT FAILURE

A lot shall be considered as failed if the allowable number of failures according to Chart IV or V of this specification, as relevant, has been exceeded.

In the case of lot failure, the Manufacturer shall act in accordance with Para. 4.3.1 of this specification.

8.6 DOCUMENTATION

For qualification testing, the qualification test data shall be documented in accordance with the requirements of Para. 10.8 of this specification.

In the case of lot acceptance testing, the data shall be documented in accordance with the requirements of Para. 10.9 of this specification.

CHART II - FINAL PRODUCTION TESTS

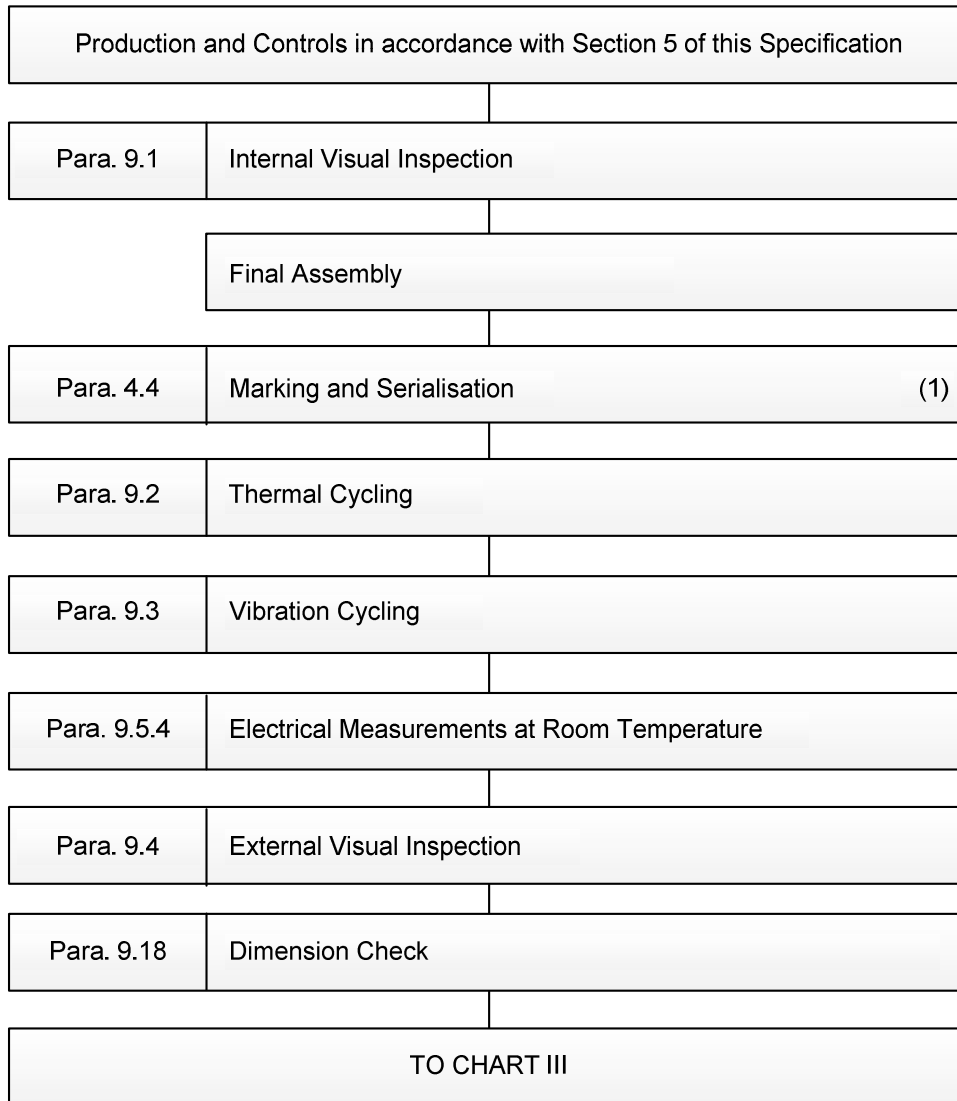

NOTES

1. Marking and Serialisation may take place at a different stage of the sequence.

CHART III - BURN-IN AND ELECTRICAL MEASUREMENTS

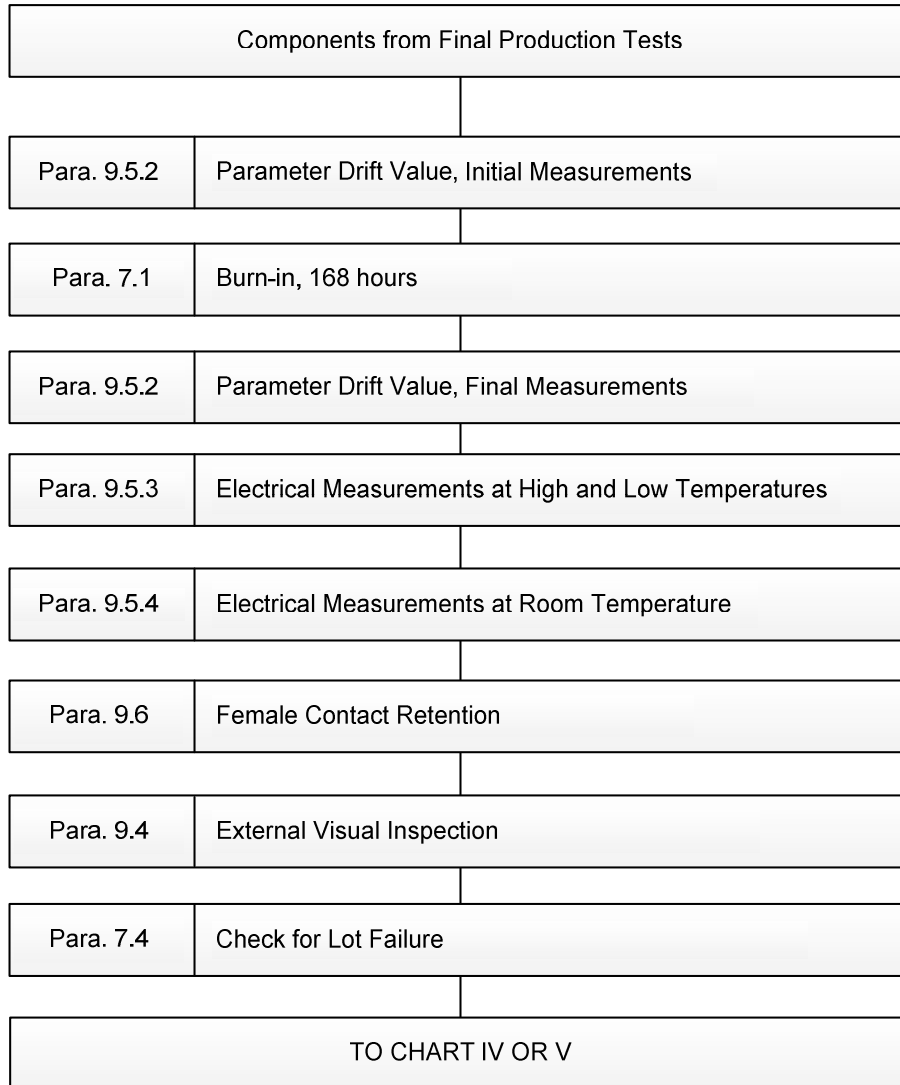
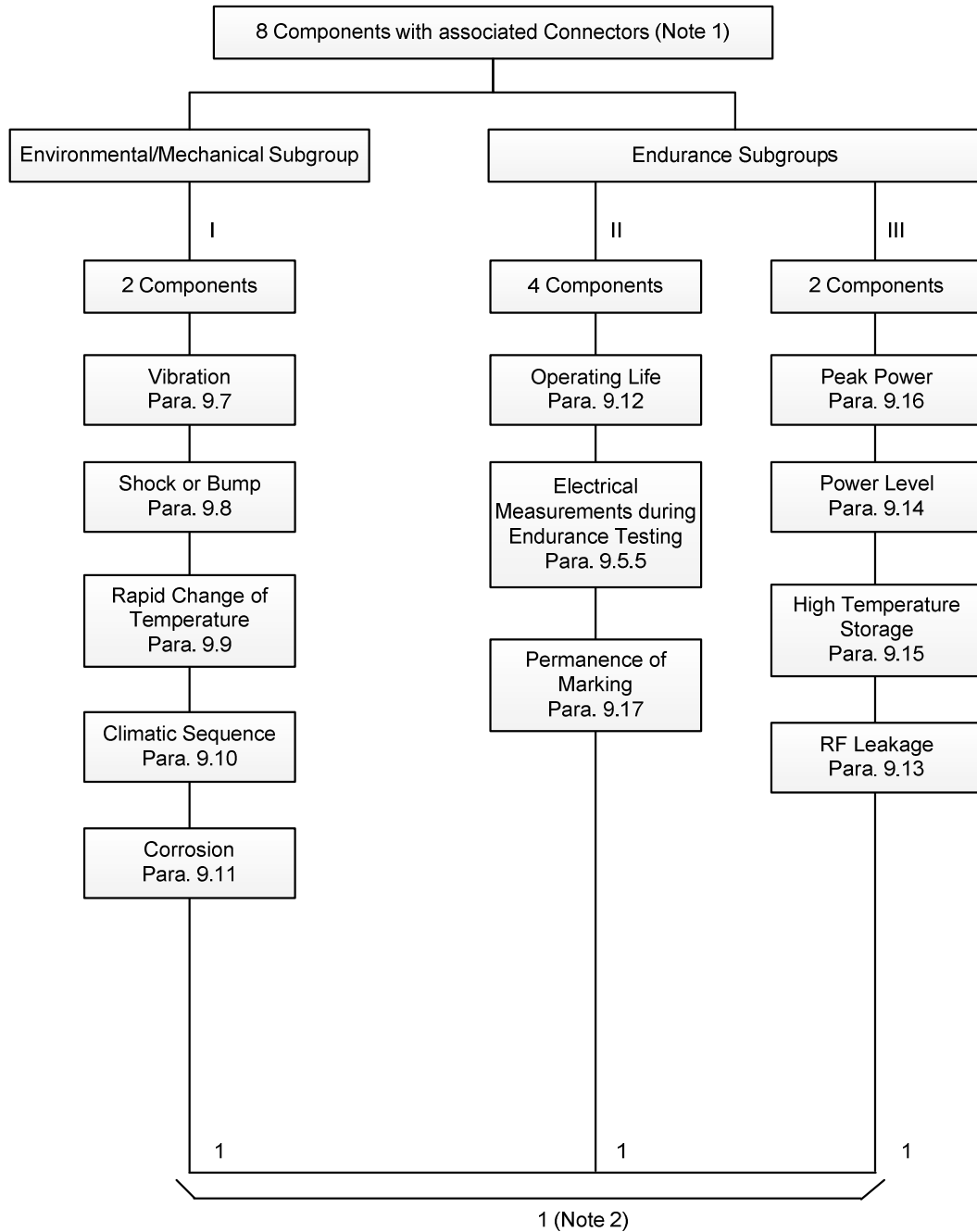

CHART IV - QUALIFICATION TESTS



Total allowable number of failed components: 1.

NOTES

1. Associated connectors shall be procured from an ESCC qualified source.
2. The tests shown in this Chart are considered to be destructive and therefore components so tested shall not form part of the delivery lot.

CHART V - LOT ACCEPTANCE TESTS

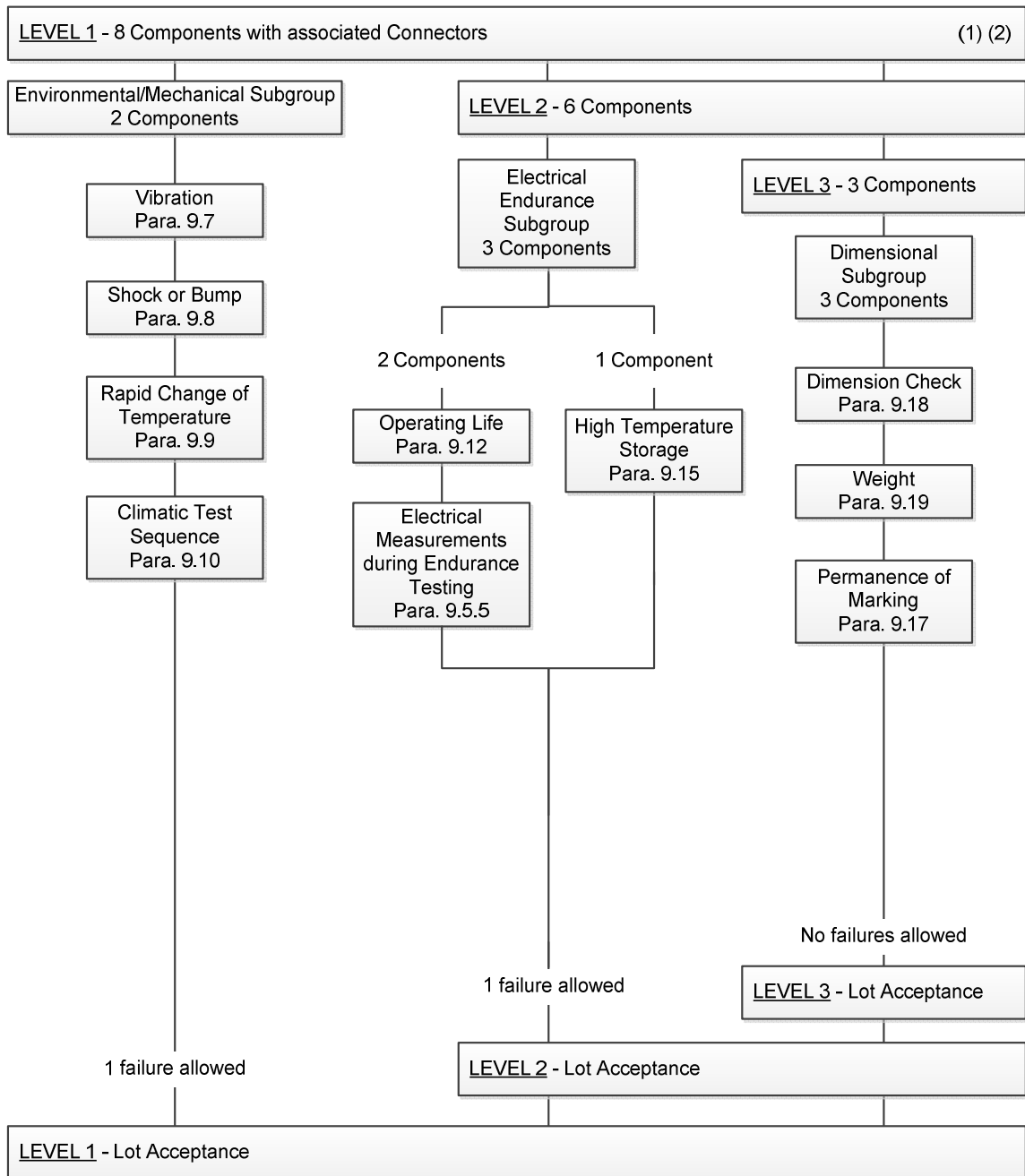

Total allowable number of failed components: 1 (which shall not be in the Dimensional Subgroup).

NOTES

1. Associated connectors shall be procured from an ESCC qualified source.
2. The tests in Level 3 are considered to be non-destructive and therefore components so tested shall form part of the delivery lot.

9 TEST METHODS AND PROCEDURES

If a Manufacturer elects to eliminate or modify a test method or procedure, the Manufacturer is still responsible for delivering components that meet all of the performance, quality and reliability requirements defined in this specification and the Detail Specification.

Documentation supporting the change shall be approved by the ESCC Executive and retained by the Manufacturer. It shall be copied, when requested, to the ESCC Executive.

The change shall be specified in the Detail Specification and in the PID

9.1 INTERNAL VISUAL INSPECTION

This inspection shall be performed in accordance with the requirements of ESCC Basic Specification No. 20400 and the Manufacturer's documents defined in the Process Identification Document (PID).

9.2 THERMAL CYCLING

The components shall be subjected to Test 'Na' of IEC Publication No. 68-2-14. The number of cycles shall be 5 with 30 minutes at each temperature extreme as specified in Table 1(b) of the Detail Specification.

9.3 VIBRATION CYCLING

The components shall be subjected to vibration in accordance with Para. 9.7 of this specification except that the number of cycles shall be 3 along the two axes specified in the Detail Specification.

9.4 EXTERNAL VISUAL INSPECTION

This inspection shall be performed according to ESCC Basic Specification No. 20500.

9.5 ELECTRICAL MEASUREMENTS

9.5.1 General

Unless otherwise stated in the Detail Specification, the following measurements shall be made under the standard conditions.

9.5.1.1 *Couplers*

9.5.1.1.1 Coupling Factor

The coupling of directional couplers shall be determined at mid-frequency in the specified frequency range using the test set-up shown in Figure I. The coupling of uni-directional couplers shall be determined as the ratio, expressed in dB, of power input to the primary line to the power available at the outputs of the secondary line, with the output end of the primary line properly terminated.

The coupling of bi-directional couplers shall be determined separately for each secondary line. The coupling factor shall be measured at mid-frequency of the frequency range defined in the Detail Specification.

9.5.1.1.2 Coupling Variation

Using the test set-up shown in Figure II, the coupling variation of directional couplers shall be measured.

The coupling variation of uni-directional couplers shall be determined by taking the difference between the maximum and minimum coupling over the specified frequency range. Such difference shall be taken as a positive number or zero.

The coupling variation of bi-directional couplers shall be determined separately for each secondary line.

The coupling variation shall be measured over the frequency range defined in the Detail Specification.

9.5.1.1.3 VSWR

- Primary Line

The VSWR of directional couplers shall be measured over the specified frequency range.

The VSWR of uni-directional couplers shall be measured at the input end of the primary line, with the output end of the primary line and the secondary line terminated in matched loads.

The VSWR of bi-directional couplers shall be measured at one end of the primary line, with the other end terminated in a matched load. The secondary line shall be terminated in matched loads.

- Secondary Line

The VSWR of directional couplers shall be measured over the specified frequency range.

The VSWR of uni-directional couplers shall be measured at the output of the secondary line with both ends of the primary line terminated in matched loads.

The VSWR of each secondary line of bi-directional couplers shall be measured at the output of the secondary line with the other line and both ends of the primary line terminated in matched loads.

The VSWR of the primary and secondary lines shall be measured over the frequency range defined in the Detail Specification with the test set-up shown in Figure III.

9.5.1.1.4 Insertion Loss

The insertion loss shall be measured by a substitution technique using radio, audio or intermediate frequency (RF, AF or IF). The insertion loss shall be measured over the frequency range defined in the Detail Specification.

9.5.1.1.5 Directivity

The directivity of directional couplers shall be determined over the specified frequency range.

The directivity of uni-directional couplers shall be computed from the ratio taken as greater than unity and expressed in dB, of the available power at the output of the secondary line for the two directions of excitation, at equal power levels, of the primary line. The secondary line shall be terminated in a matched detector.

Directivity of bi-directional couplers shall be determined separately for each secondary line.

9.5.1.2 Power Dividers

9.5.1.2.1 Average Coupling

The average coupling is the arithmetic average of the measured coupling factor (in dB) between input and the two outputs at the low, medium and high end of the frequency range specified in the Detail Specification using the test set-up shown in Figure I. The value of the average coupling cannot exceed that specified in the Detail Specification over the specified frequency range.

9.5.1.2.2 Amplitude Balance or Amplitude Equality

When power dividers are tested, using the test set-up shown in Figure I, the difference between the measured coupling at the two outputs (in dB) shall be specified over the specified frequency range. Where the limit is expressed as $\pm X$ dB, it shall be interpreted to allow a maximum difference of $2X$ dB.

The amplitude balance shall be measured at the low end, middle and high ends of the frequency range specified in the Detail Specification.

9.5.1.2.3 Phase Balance

Using the test set-up shown in Figure II, the phase balance of the item shall be measured between the output ports with the other co-linear output port and the adjacent isolated port terminated in matched loads.

The phase balance shall be measured at the low end, middle and high ends of the frequency range specified in the Detail Specification.

9.5.1.2.4 VSWR

Using the test set-up shown in Figure III, the VSWR of each port shall be measured across the full frequency range by the swept frequency technique. Each unused port shall be terminated in a matched load. The VSWR may also be measured at fixed frequencies, equally spaced points (7 minimum) across the frequency range. The VSWR cannot exceed the value of the Detail Specification over the frequency range.

9.5.1.2.5 Insertion Loss

The insertion loss shall be determined by subtracting the nominal value of the divider from the measured average coupling value which shall be measured over the frequency range defined in the Detail Specification.

9.5.1.2.6 Isolation

When power dividers are tested, using the test set-up shown in Figure II, the ratio of the input power to the power from the isolated port shall be as specified over the specified frequency range. The isolation shall be measured over the frequency range specified in the Detail Specification.

FIGURE I - ISOLATION, COUPLING VARIATION AND AMPLITUDE BALANCE MEASUREMENTS TEST SET-UP

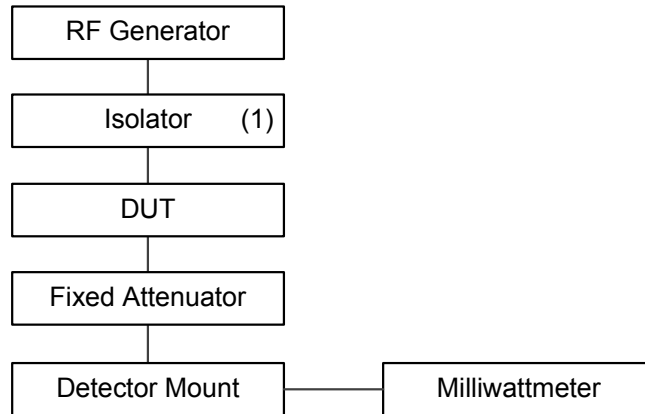

NOTES

1. Or attenuator.

FIGURE II - COUPLING VARIATION, INSERTION LOSS, DIRECTIVITY, ISOLATION, PHASE BALANCE TEST SET-UP

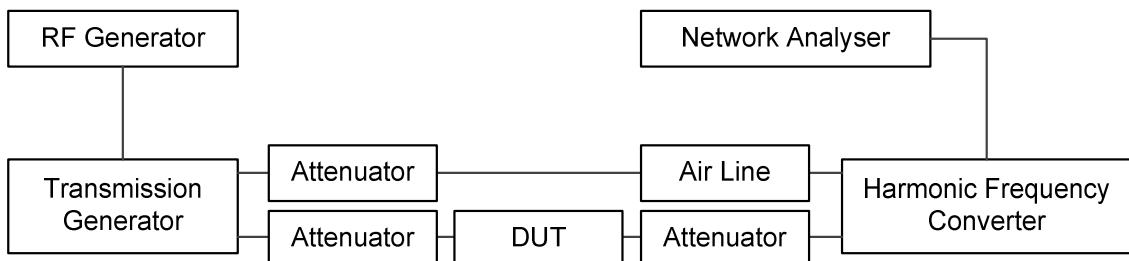
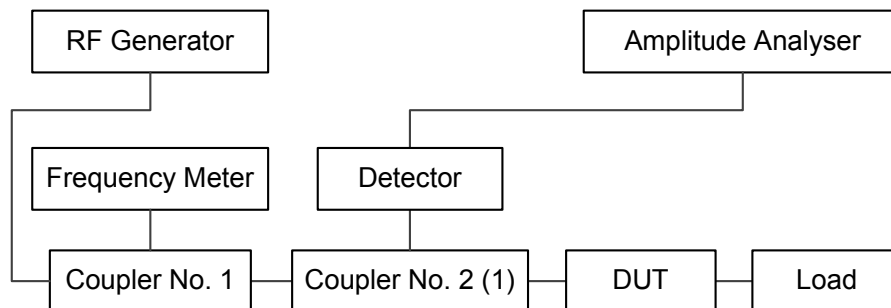

FIGURE III - SWEEP FREQUENCY VSWR TEST SET-UP



NOTES

1. Or reflectometer bridge.

9.5.2 Parameter Drift Value Measurements

At each of the relevant data points, measurements shall be made of all parameters listed in Table 4 of the Detail Specification. All values obtained shall be recorded against serial numbers and the parameter drift calculated.

9.5.3 Electrical Measurements at High and Low Temperatures

The electrical measurements at high and low temperatures shall be made in accordance with Table 3 of the Detail Specification. The lower and upper temperature shall be as specified in the Detail Specification. All values obtained shall be recorded against serial numbers.

9.5.4 Electrical Measurements at Room Temperature

The measurements of electrical characteristics shall be made in accordance with Table 2 of the Detail Specification. All values obtained shall be recorded against serial numbers, except during Final Production Tests (Chart III).

9.5.5 Electrical Measurements during Endurance Testing

At each of the relevant data points specified for endurance testing, measurements shall be made of all parameters listed in the appropriate part of Table 6 of the Detail Specification. All values obtained shall be recorded against serial numbers and the parameter drift calculated, if required.

9.6 FEMALE CONTACT RETENTION

The female contact of every connector used on the components shall be submitted to a withdrawal test with "go" and "no-go" weights and pins as specified in the Detail Specification.

9.7 VIBRATION

9.7.1 Mounting

The specimens shall be mechanically connected to the vibration generator either directly or by means of a fixture as specified below. Mounting fixtures shall be such that they enable the specimen to be vibrated in 3 mutually perpendicular axes in turn, which should be so chosen that faults are most likely to be revealed. If the component is provided with specific means of mounting, they shall be used as specified in the Detail Specification and any additional restraining straps should be avoided.

Unless otherwise specified, components not provided with specific mounting means shall be clamped by the body. If external connections, necessary for measuring and supply purposes, are specified in the Detail Specification, they should add the minimum restraint and mass.

9.7.2 Procedure

The components shall be subjected to Test 'Fc' of IEC Publication No. 68-2-6, Procedure B4. Sweep frequency: 10-2000-10 Hz. The entire frequency range of 10 to 2000 Hz and return to 10Hz shall be traversed in 10 minutes. This cycle shall be performed 12 times in each of the 3 directions (i.e. 36 times in total), so that the motion is applied for a total period of approximately 6 hours. The vibration amplitude shall be 1.5mm (total display) or 20g, whichever is smaller.

9.7.3 Measurement during Vibration

During the last cycle in each direction, an electrical measurement shall be made to determine intermittent contact of 0.5ms or longer duration, or open or short circuiting.

9.7.4 Visual Inspection

After vibration, the components shall be visually inspected and there shall be no evidence of damage.

9.8 SHOCK OR BUMP

9.8.1 Shock

9.8.1.1 *Mounting*

The specimens shall be fixed to the shock machine, either directly or by means of a fixture as specified below. Mounting fixtures shall enable the specimens to be subjected to shocks along the 3 mutually perpendicular axes in turn. When the component is provided with specific mounting means, these shall be used as specified in the Detail Specification and any additional restraining straps should be avoided. Unless otherwise specified, components not provided with specific mounting means shall be clamped by the body. When external connections, necessary for measuring and supply purposes, are specified in the Detail Specification, they should add the minimum restraint and mass.

9.8.1.2 *Procedure*

The components shall be subjected to Test 'Ea' of IEC Publication No. 68-2-27. Unless otherwise specified in the Detail Specification, the following conditions apply:

- Shape of shock pulse: half sine.
- Peak acceleration: 50g.
- Duration of pulse: 11ms.
- Number of shocks: 18 (3 shocks in each direction along the 3 perpendicular axes of the test specimen).

9.8.1.3 *Visual Inspection and Electrical Measurements*

After shock, the components shall be visually examined and there shall be no evidence of damage. Electrical measurements as specified in Table 6 of the Detail Specification shall be performed and shall not exceed the specified limits.

9.8.2 Bump

9.8.2.1 *Mounting*

As specified in Para. 9.8.1.1, the word "shock" to be replaced by "bump".

9.8.2.2 *Procedure*

The components shall be subjected to Test 'Eb' of IEC Publication No. 68-2-29. Unless otherwise specified in the Detail Specification, the following conditions shall apply:

- Peak acceleration: 390m/s^2 .
- Number of bumps: 4000 ± 10 .

9.8.2.3 *Visual Inspection and Electrical Measurements*

After bump, the components shall be visually examined and there shall be no evidence of damage. Electrical measurements as specified in Table 6 of the Detail Specification shall be performed and shall not exceed the specified limits.

9.9 RAPID CHANGE OF TEMPERATURE

9.9.1 Initial Measurement

None.

9.9.2 Procedure

The components shall be subjected to Test 'Na' of IEC Publication No. 68-2-14. The number of cycles shall be 5 with 30 minutes at each temperature extreme unless otherwise specified in Table 1(b) of the Detail Specification.

9.9.3 Recovery and Final Measurement

The duration of recovery shall be 24 \pm 2 hours at room temperature conditions. After recovery, the components shall be visually examined and there shall be no evidence of damage. Electrical measurements as specified in Table 6 of the Detail Specification shall be performed and shall not exceed the specified limits.

9.10 CLIMATIC SEQUENCE

9.10.1 Initial Measurements

No initial measurements are required.

9.10.2 Dry Heat

The components shall be subjected to Test 'Ba' of IEC Publication No. 68-2-2. Duration: 2 hours. Maximum operating temperature as prescribed in Table 1(b) of the Detail Specification. While still at the specified high temperature and at the end of the period of high temperature, electrical measurements as specified in Table 3 of the Detail Specification shall be performed and shall not exceed the specified limits.

9.10.3 Damp Heat, Accelerated, First Cycle

Unless otherwise specified in the Detail Specification, the components shall be subjected to Test 'Db' of IEC Publication No. 68-2-30 for one cycle of 24 hours. After recovery, the components shall be subjected immediately to the cold test.

9.10.4 Cold Test

The components shall be subjected to Test 'Aa' of IEC Publication No. 68-2-1. Duration: 2 hours. Minimum operating temperature as prescribed in Table 1(b) of the Detail Specification. While still at the specified low temperature and at the end of the period of low temperature, electrical measurements as specified in Table 3 of the Detail Specification shall be performed and shall not exceed the specified limits.

9.10.5 Low Air Pressure

The components shall be subjected to Test 'M' of IEC Publication No. 68-2-13 under the following conditions:

- 1 to 2 minutes at 85mbar.
- Temperature: +15 to +35°C.

Rated power shall be applied for 1 to 2 minutes immediately after the pressure of 85mbar has been attained.

9.10.6 Damp Heat, Accelerated, Remaining Cycles

The components shall be subjected to Test 'Db' of IEC Publication No. 68-2-30 for 5 cycles of 24 hours.

9.10.7 Final Measurements

After a recovery period of 1 to 24 hours, the components shall be visually inspected according to ESCC Basic Specification No. 20500 and there shall be no evidence of mechanical damage. Electrical measurements as specified in Table 6 of the Detail Specification shall be performed and shall not exceed the specified limits.

9.11 CORROSION

The components, equipped with dust covers, shall be submitted to this test in accordance with IEC Publication No. 68-2-11 for a duration of 48 hours. After exposure, they shall be washed, shaken and lightly brushed and then allowed to dry at +40°C for 24 hours. The components shall then be inspected; no base metal shall be exposed on the body or connectors. Particular attention shall be paid to observation of galvanic action.

9.12 OPERATING LIFE

9.12.1 Initial Measurements

The parameters listed in Table 6 of the Detail Specification Shall be measured at room temperature.

9.12.2 Mounting

The components shall be placed on a rack of thermal insulating material. There shall be no undue draught over the components; only natural convection, resulting from the hot components, may occur.

9.12.3 Procedure

The components shall be submitted to an operating life test of 1000 hours, consisting of cycles of 1 hour with power "ON" and 1 hour with power "OFF", under the conditions defined in the Detail Specification.

Intermediate measurements shall be performed at 168 and 500 hours. After not less than 1000 hours, the components shall be allowed to cool at room temperature for not less than 1 hour and not more than 2 hours.

9.12.4 Final Measurements

The components shall be visually examined; there shall be no evidence of damage. Electrical measurements as specified in Table 6 of the Detail Specification shall be performed and shall not exceed the specified limits.

9.13 RF LEAKAGE

The swept frequency measurement shall cover the whole frequency range in steps not exceeding an octave band. The test circuit shall be as shown in Figure IV.

- (a) Apply a fixed amount of RF power to a transmission line 'a' in series with a variable attenuator and a network analyser.
- (b) This variable attenuator is set at an attenuation equal to the RF leakage specified in Table 1(b) of the Detail Specification.
- (c) Reset the attenuator to 0dB, insert in series the component under test terminated on adapted loads without leakage.
- (d) Use an adapted flexible cable terminated by an antenna and "sniff" the component under test as closely as possible without touching it.
- (e) Any attenuation in excess of the value specified in (b) above shall be cause for rejection of the part.

FIGURE IV - TEST SET-UP FOR RF LEAKAGE TEST

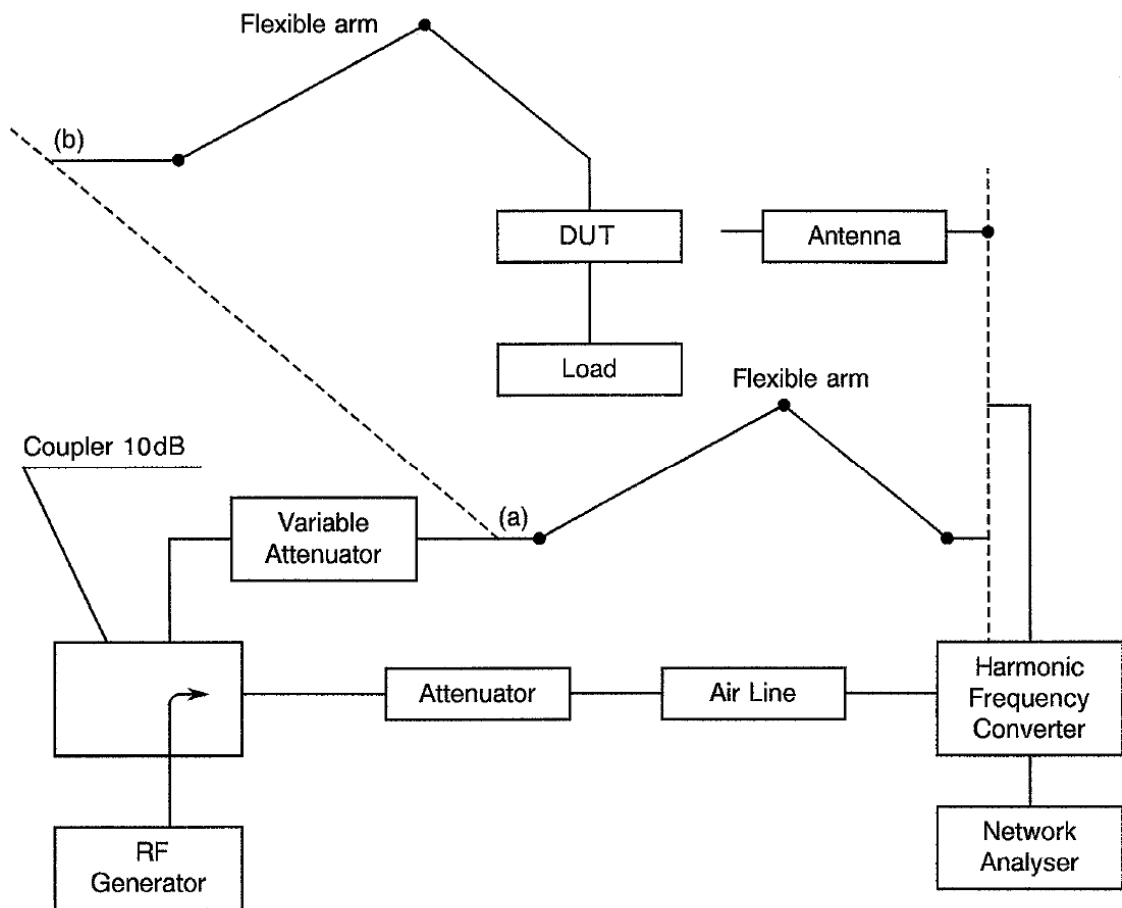

9.14 POWER LEVEL

One and a half times rated power shall be applied to the component under test and shall be maintained for 15 minutes after the item has reached thermal equilibrium. Thermal equilibrium has been reached when the temperature of the item has not changed by more than 5°C over a period of 5 minutes. Following the exposure, electrical measurements as specified in Table 6 of the Detail Specification shall be performed and shall not exceed the specified limits.

9.15 HIGH TEMPERATURE STORAGE

9.15.1 Initial Measurement

The contact resistance shall be measured between input and direct output and between isolated output and coupled output, using a 4-wire ohm-meter.

9.15.2 Procedure

The components shall be placed in an oven at the maximum rated storage temperature specified in the Detail Specification. After not less than 1000 hours, they shall be removed from the oven and allowed to cool to room temperature for not less than 1 hour and not more than 2 hours.

9.15.3 Final Measurements

The contact resistance shall be measured as specified in Para. 9.15.1 and the results shall meet the requirements of Table 6 of the Detail Specification. The components shall be visually examined; there shall be no evidence of damage. Electrical measurements as specified in Table 6 of the Detail Specification shall be performed and shall not exceed the specified limits.

9.16 PEAK POWER

The component shall be placed in still air and free space at room temperature. The specified peak power shall be applied 10 times to each line for the time specified in Table 6 of the Detail Specification. After the component has cooled down to room temperature, electrical measurements as specified in Table 6 of the Detail Specification shall be performed and shall not exceed the specified limits.

9.17 PERMANENCE OF MARKING

In accordance with ESCC Basic Specification No. 24800.

9.18 DIMENSION CHECK

All dimensions specified in Figure 2 of the Detail Specification shall be verified on 3 samples. Dimensions shall be measured either by the use of conventional measuring instruments (Vernier calipers, rules, micrometers, etc.) or by gauges. Gauges shall have dimensions and characteristics that comply with the requirements specified in the drawing of the components. The tolerances specified in Figure 2 of the Detail Specification shall not be exceeded.

9.19 WEIGHT

The weight of the specimen shall not exceed that given in the Detail Specification.

10 DATA DOCUMENTATION

10.1 GENERAL

For the qualification approval records and with each component delivery, a data documentation package is required. Depending on the testing level and lot acceptance level specified for the component, this package shall be compiled from:

- (a) Cover sheet (or sheets).
- (b) List of equipment (testing and measuring).
- (c) List of test references.
- (d) Special in-process control test data.
- (e) Final production test data (Chart II) (but see Para. 10.6).
- (f) Burn-in and electrical measurement data (Chart III).
- (g) Qualification test data (Chart IV).
- (h) Lot acceptance test data (Chart V) (when applicable).
- (i) Failed component list (see Paras. 7.3 and 8.4) and failure analysis report (see Para. 8.4)
- (j) Certificate of Conformity.

Items (a) to (j) inclusive shall be grouped, preferably as subpackages and, for identification purposes, each page shall include the following information:

- ESCC Component Number.
- Manufacturer's name.
- Lot identification.
- Date of establishment of the document.
- Page number.

10.1.1 Qualification Approval

In the case of qualification approval, the items listed in Para. 10.1 (a) to (j) less item (h) are required.

10.1.2 Testing Level "B"

10.1.2.1 *Qualified Components*

For deliveries of qualified components, the following documentation shall be supplied:

- (a) Cover sheet (if all of the information is not included on the Certificate of Conformity).
- (b) Certificate of Conformity (including range of delivered serial numbers).
- (c) Attributes record of measurements, tests and inspections performed in Chart II, Chart III (including PDA figure) and Chart V (where applicable).
- (d) Failed components list.

10.1.2.2 *Unqualified Components*

For deliveries of unqualified components, the documentation to be supplied shall be in accordance with Para. 10.1.2.1 plus the following:

- (a) Read and record data from Chart III.
- (b) Special in-process control data (where applicable).
- (c) Failure analysis report on failed components.

10.1.3 Data Retention/Data Access

If not delivered, all data shall be retained by the Manufacturer for a minimum of 5 years during which time it shall be available to the ESCC Executive and the Orderer, if requested, for review. The Manufacturer shall deliver variables Data/Reports to the Orderer if required by the Purchase Order.

10.2 COVER SHEET(S)

The cover sheet(s) of the data documentation package shall include as a minimum:

- (a) Reference to the Detail Specification, including issue and date.
- (b) Reference to the applicable ESCC Generic Specification, including issue and date.
- (c) Component type and number.
- (d) Lot identification.
- (e) Range of delivered serial numbers.
- (f) Number of purchase order.
- (g) Information relative to any additions to this specification and/or the Detail Specification.
- (h) Manufacturer's name and address.
- (i) Location of the manufacturing plant.
- (j) Signature on behalf of Manufacturer.
- (k) Total number of pages of the data package.

10.3 LIST OF EQUIPMENT USED

A list of equipment used for tests and measurements shall be prepared, if not in accordance with the data given in the Process Identification Document (PID). Where applicable, this list shall contain inventory number, Manufacturer's type number, serial number, etc. This list shall indicate for which tests such equipment was used.

10.4 LIST OF TEST REFERENCES

This list shall include all Manufacturer's references or codes which are necessary to correlate the test data provided with the applicable tests specified in the tables of the Detail Specification.

10.5 SPECIAL IN-PROCESS CONTROL DATA

As specified in the Detail Specification.

10.6 FINAL PRODUCTION TEST DATA (CHART II)

A test result summary shall be compiled showing the total number of components submitted to, and the total number rejected after, each of the following tests:

- Internal Visual Inspection (Para. 9.1).
- Environmental Tests (Paras. 9.2 and 9.3).
- Electrical Measurements at Room Temperature (Para. 9.5.4).
- External Visual Inspection and Dimension Check (Para. 9.4).

The final production test data shall form an integral part of the data documentation package, but it is not a mandatory requirement that it be delivered with the qualification lot or delivery lot. However, the data package to be delivered shall contain the information as detailed in Para. 10.1.2 or at least shall contain a list of final production tests actually performed and a certification that the data is available for review.

10.7 BURN-IN AND ELECTRICAL MEASUREMENT DATA (CHART III)

10.7.1 Testing Level "B"

For components of testing level "B", all data shall refer to the relevant serial numbers. Against these serial numbers, data shall be recorded for the following:

- (a) 0-hour measurement for burn-in.
- (b) 168-hour measurement for burn-in.
- (c) Delta values after burn-in.
- (d) Values obtained during measurements at high and low temperatures (Table 3 of the Detail Specification).
- (e) Values obtained during measurements of electrical characteristics (Table 2 of the Detail Specification).
- (f) Failures during external visual inspection.

10.7.2 Testing Level "C"

Not applicable.

10.8 QUALIFICATION TEST DATA (CHART IV)

All data shall be referenced to the relevant serial numbers. Detailed records shall be provided of the components submitted to each test in each of the subgroups and of those rejected. Detailed data shall be provided of all electrical measurements made in accordance with Tables 2 and 6 of the Detail Specification, as and where applicable.

10.9 LOT ACCEPTANCE TEST DATA (CHART V)

10.9.1 Testing Level "B"

All data shall be referenced to the relevant serial numbers. Detailed records shall be provided of the components submitted to each test in each of the subgroups (as relevant to the lot acceptance level) and of those rejected.

Detailed data shall be provided of all electrical measurements made in accordance with Tables 2, 3 and 6 of the Detail Specification, as and where applicable.

10.9.2 Testing Level "C"

Not applicable.

10.10 FAILED COMPONENTS LIST AND FAILURE ANALYSIS REPORT

The failed component list and failure analysis report shall provide full details of:

- (a) The reference number and description of the test or measurement performed as defined in this specification and/or the Detail Specification.
- (b) The serial number of the failed component.
- (c) The failed parameter and the failure mode of the component.
- (d) Detailed failure analysis, if requested.

10.11 CERTIFICATE OF CONFORMITY

A Certificate of Conformity shall be established as defined in ESCC Basic Specification No. 20100.

11 DELIVERY

For qualification approval, the disposition of the qualification test lot and its related documentation shall be as specified in ESCC Basic Specification No. 20100 and the relevant paragraphs of Section 10 of this specification.

For procurement, for each order, the items forming the delivery are:

- (a) The delivery lot.
- (b) The components used for lot acceptance testing, (when applicable), but not forming part of the delivery lot (see Paras. 8.2.3(b), 8.2.4 and 8.2.5).
- (c) The relevant documentation in accordance with the requirements of Section 10 of this specification.

In the case of a component for which a valid qualification approval is in force, all data of all components submitted to LA1 and LA2 testing shall also be copied, when requested, to the ESCC Executive.

12 PACKAGING AND DESPATCH

The packaging and despatch of components to this specification shall be in accordance with the requirements of ESCC Basic Specification No. 20600.