

Titre / Title

HIGH RELIABILITY

RF COAXIAL CONNECTORS

GENERIC SPECIFICATION

Rédigé par / Written by	Responsabilité / Responsibility	Date	Signature
S. POIZAT	Space Project manager	21/09/2017	
Vérifié par / Verified by			
V EUDELIN	Space B. U. Manager	21/09/2017	
Approuvée par / Approved by			
C. DAVENEL	Space Quality Manager	21/09/2017	

DOCUMENTATION CHANGE NOTICE

REVISION OR ISSUE	DATE	CHANGE
1-	27/02/03	Creation – Replacement of specification RAD-C-2612 issue 4-
1 A	07/12/05	Updated to clarify the definition of a connector under Radiall's specification
1 B	09/02/06	Minor corrections in scope paragraph
1 C	06/10/08	§9.17 Corona Level: Frequency unit corrected: KHz instead of Hz
1 D	05/01/09	Updated to clarify the authorized “allowable failure” in Chart VI and V.
1 E	10/10/11	Updated to correct the reference of paragraph in page 10: §6.5: ...specified in paragraph 4.2.1... instead of of 4.3.1
1 F	17/02/12	Updated to delete “engagement and separation force test” in chart II. Delete §9.3.2: this test is already performed in §5.2.1 during the in process control.
2 -	21/09/17	Updated with: <ul style="list-style-type: none"> - Change Radiall logo design - Corrected typing error in §10.1.2, read “the items (d) and (h)” instead of “the items (d) and (b)” - Modification of Qualification and LAT chart: canceled “corrosion test”, modify the Corona test: included in “Power test”(§9.17) - Change of temperature test (§9.26): Changed temperature limit: at each extrem temperature given in the Technical Data Sheet instead of -20°C to +70°C



TABLE OF CONTENTS

- 1. **INTRODUCTION** 6
 - 1.1 SCOPE6
- 2. **APPLICABLE DOCUMENTS**..... 6
- 3. **TERMS, DEFINITIONS, ABBREVIATIONS, SYMBOLS AND UNITS** 6
- 4. **REQUIREMENTS** 7
 - 4.1 GENERAL.....7
 - 4.1.1 Specifications..... 7
 - 4.1.2 Conditions and Methods of Test 7
 - 4.1.3 Manufacturer’s Responsibility for performance of Tests and Inspections 7
 - 4.2 DELIVERABLE COMPONENTS.....7
 - 4.2.1 Lot failure 7
 - 4.2.2 Testing and Lot Acceptance Levels..... 7
 - 4.3 MARKING7
 - 4.4 MATERIALS AND FINISHES.....7
- 5. **PRODUCTION CONTROL**..... 8
 - 5.1 GENERAL.....8
 - 5.2 SPECIAL IN-PROCESS CONTROLS8
 - 5.2.1 Contact Engagement and Separation Forces 8
 - 5.2.2 External Visual Inspection..... 8
- 6. **FINAL PRODUCTION TESTS** 10
 - 6.1 GENERAL.....10
 - 6.2 TEST METHODS AND CONDITIONS.....10
 - 6.3 FAILURE CRITERIA.....10
 - 6.3.1 Parameter Limit Failure..... 10
 - 6.3.2 Other failures..... 10
 - 6.4 FAILED COMPONENTS.....10
 - 6.5 LOT FAILURE10
 - 6.5.1 Lot failure during Sample Testing 10
 - 6.6 DOCUMENTATION10
- 7. **BURN-IN AND ELECTRICAL MEASUREMENTS (CHART III)**..... 11
- 8. **QUALIFICATION APPROVAL AND LOT ACCEPTANCE TESTS**..... 11
 - 8.1 QUALIFICATION TESTING11
 - 8.1.1 General..... 11
 - 8.1.2 Distribution within the Qualification Test Lot..... 11
 - 8.2 LOT ACCEPTANCE TESTING.....11
 - 8.2.1 General..... 11
 - 8.2.2 Distribution within the Sample Lot for Lot Acceptance Testing..... 11
 - 8.2.3 Lot Acceptance Level 3 Testing (LAT3)..... 11
 - 8.2.4 Lot Acceptance Level 2 Testing (LAT2)..... 11
 - 8.2.5 Lot Acceptance Level 1 Testing (LAT1)..... 12
 - 8.3 FAILURE CRITERIA.....12
 - 8.3.1 Environmental and Mechanical Test Failures..... 12
 - 8.3.2 Electrical failures 12
 - 8.3.3 Other failures..... 12
 - 8.3.4 Major failures..... 12
 - 8.4 FAILED COMPONENTS.....12
 - 8.5 LOT FAILURE13



GENERIC SPECIFICATION

REF. : RAD-GEN-CONN-001

Date:
September 21st, 17

ED/REV:
2 -

PAGE:
4/ 33

8.6 DOCUMENTATION13

9. TEST METHODS AND PROCEDURES..... 17

9.1 INSULATION RESISTANCE17

9.2 DIELECTRIC WITHSTANDING VOLTAGE17

9.3 CONTACT ENGAGEMENT AND SEPARATION FORCES17

 9.3.1 *In-process Control* 17

9.4 COUPLING PROOF TORQUE17

9.5 MATING AND UNMATING FORCES17

 9.5.1 *Bayonet and Screw coupling* 17

 9.5.2 *Push-pull coupling* 17

9.6 CENTRE CONTACT RETENTION18

9.7 SEAL TEST18

 9.7.1 *Hermetically Sealed Connectors* 18

 9.7.2 *Leakage (Barrier-sealed Connectors)* 18

 9.7.3 *Leakage (Panel-sealed Connectors)* 18

9.8 EXTERNAL VISUAL INSPECTION18

9.9 CONTACT RESISTANCE18

 9.9.1 *Method A – Using Separate Power Supplies and Meters* 18

 9.9.2 *Method B – Using Integrated Power Supplied and Meters with a 4 Terminal Bridge Arrangement* 18

 9.9.2.1 *Equipment* 18

 9.9.2.2 *Centre contacts* 19

 9.9.2.3 *Outer contacts* 19

9.10 VIBRATION22

 9.10.1 *Mounting* 22

 9.10.2 *Procedure* 22

 9.10.3 *Measurement during Vibration* 22

 9.10.4 *Final Measurements* 22

9.11 SHOCK OR BUMP22

 9.11.1 *Shock* 22

 9.11.1.1 *Mounting* 22

 9.11.1.2 *Procedure* 23

 9.11.1.3 *Visual inspection* 23

 9.11.2 *Bump* 23

 9.11.2.1 *Mounting* 23

 9.11.2.2 *Procedure* 23

 9.11.2.3 *Visual inspection* 23

9.12 RAPID CHANGE OF TEMPERATURE23

 9.12.1 *Initial measurements* 23

 9.12.2 *Procedure* 23

 9.12.3 *Recovery and Final Measurements* 23

9.13 CLIMATIC SEQUENCE24

 9.13.1 *Initial Measurements* 24

 9.13.2 *Dry heat* 24

 9.13.3 *Damp heat, accelerated, First cycle* 24

 9.13.4 *Cold test* 24

 9.13.5 *Low Air Pressure* 24

 9.13.6 *Damp heat, Accelerated, Remaining Cycles* 24

 9.13.7 *Final measurements* 24

9.14 CABLE RETENTION FORCE (CABLE CONNECTORS ONLY)24

9.15 CABLING AND CRIMPING CAPABILITY (CABLE CONNECTORS ONLY)25

9.16 VOLTAGE STANDING WAVE RATIO (VSWR) OR REFLECTION COEFFICIENT25

9.17 POWER TEST26

9.18 ENDURANCE26

9.19 RF INSERTION LOSS28

9.20 CORROSION28

9.21 RESIDUAL MAGNETISM28

9.22 SOLDERING PROOF (SOLDER TYPE CONNECTORS ONLY)31



GENERIC SPECIFICATION

REF. : RAD-GEN-CONN-001

Date:
September 21st, 17

ED/REV:
2 -

PAGE:
5/ 33

9.23	RF LEAKAGE (SEMI-RIGID CABLE CONNECTORS ONLY).....	31
9.24	HIGH TEMPERATURE STORAGE.....	31
9.25	DIMENSION CHECK.....	31
9.26	CHANGE OF TEMPERATURE.....	31
9.27	PERMANENCE OF MARKING.....	31
10.	<u>DATA DOCUMENTATION</u>	31
10.1	GENERAL.....	31
10.1.1	<u>Qualification approval</u>	31
10.1.2	<u>Testing</u>	32
10.2	COVER SHEET(S).....	32
10.3	LIST OF EQUIPMENT USED.....	32
10.4	LIST OF TEST REFERENCES.....	32
10.5	SPECIAL IN-PROCESS CONTROL DATA.....	32
10.6	FINAL PRODUCTION TEST DATA (CHART II).....	32
10.7	BURN-IN AND ELECTRICAL MEASUREMENT DATA (CHART III).....	32
10.8	QUALIFICATION TEST DATA (CHART IV).....	32
10.9	LOT ACCEPTANCE TEST DATA (CHART V).....	33
10.9.1	<u>Testing</u>	33
10.10	FAILED COMPONENTS LIST AND FAILURE ANALYSIS REPORT.....	33
10.11	CERTIFICATE OF CONFORMITY.....	33
11.	<u>DELIVERY</u>	33
12.	<u>PACKAGING AND DESPATCH</u>	33

LIST OF CHARTS

<u>CHART I - TESTING LEVELS</u>	9
<u>CHART II - FINAL PRODUCTION TESTS</u>	14
<u>CHART III - BURN-IN AND ELECTRICAL MEASUREMENTS (Not applicable)</u>	14
<u>CHART IV - QUALIFICATION TESTS</u>	15
<u>CHART V – LOT ACCEPTANCE TESTS</u>	16

LIST OF FIGURES

<u>FIGURE I (a) – CONTACT RESISTANCE MEASUREMENTS – METHOD A</u>	20
<u>FIGURE I (b) – CONTACT RESISTANCE MEASUREMENT – METHOD B</u>	21
<u>FIGURE II (a) - SWEPT FREQUENCY TEST SET-UP – SCALAR METHOD</u>	26
<u>FIGURE II (b) - SWEPT FREQUENCY TEST SET-UP – VECTORIAL METHOD (2 PORTS)</u>	27
<u>FIGURE II (c) - SWEPT FREQUENCY TEST SET-UP – VECTORIAL METHOD (1 PORT)</u>	27
<u>FIGURE III (a) – METHOD OF RF INSERTION LOSS MEASUREMENT</u>	29
<u>FIGURE III (b) – VECTOR METHOD OF RF INSERTION LOSS MEASUREMENT</u>	30
<u>FIGURE III (c) – CABLE ASSEMBLY FOR RF INSERTION LOSS MEASUREMENT</u>	30

	GENERIC SPECIFICATION		
	REF. : RAD-GEN-CONN-001		
	Date: September 21 st , 17	ED/REV: 2 -	PAGE: 6/ 33

1. INTRODUCTION

1.1 SCOPE

This specification defines the general requirements for procurement and delivery of RF Coaxial Connectors for Space application.

In order to follow the design improvement of standard products, RADIALL reserves the right to update design and manufacturing process of products covered by this specification without prior notification.

This specification contains the appropriate inspection and test schedules and also specifies the data documentation requirements.

The qualification test and Lot Acceptance Test are performed only with customer order.

2. APPLICABLE DOCUMENTS

- The following documents form part of, and shall be read in conjunction with this specification. The relevant issues shall be those in effect on the date of placing the purchase order.
 - ECSS-Q-70-02, A Thermal Vacuum Test for the Screening of Space Materials
 - IEC Publication N° 60068, Basic Environmental Testing Procedures
 - IEC Publication N° 60169-1, RF Coaxial Connectors, General Requirements and Measuring Methods
 - IEC Publication N° 60410, Sampling Plans and Procedures for Inspection by Attributes
 - IEC Publication N° 61726 Cable assemblies, cables, connectors and passive microwave components - Screening attenuation measurement by the reverberation chamber method
 - MIL-PRF-39012 – Generic Specification for Connectors, Coaxial, Radio frequency
 - ESA-SCC 20600 – Preservation, Packaging and Dispatch of SCC Electronic Components
 - ESA-SCC 21300 – Terms, Definitions, Abbreviations, Symbols and Units
 - ESA-SCC 21700 – General Requirements for the Marking of SCC Components
 - ESA-SCC 24800 – Resistance to solvents of Marking, Materials and Finishes

3. TERMS, DEFINITIONS, ABBREVIATIONS, SYMBOLS AND UNITS

The terms, definitions, abbreviations, symbols and units specified in ESA/SCC Basic Specification N° 21300 shall apply.

	GENERIC SPECIFICATION		
	REF. : RAD-GEN-CONN-001		
	Date: September 21 st , 17	ED/REV: 2 -	PAGE: 7/ 33

4. REQUIREMENTS

4.1 GENERAL

The test requirements for qualification approval of a component shall comprise Final Production Tests (see Chart II) and Qualification Testing (see Chart IV).

The test requirements for procurement of components so qualified shall comprise Final Production Tests (Chart II) together with a level Acceptance Testing (see Chart V) to be specified by the orderer.

4.1.1 Specifications

For qualification approval, procurement (including lot acceptance testing) and delivery of components in conformity with this specification, the specifications listed in Section 2 of this document shall apply in total otherwise specified herein or in the Detail Specification.

4.1.2 Conditions and Methods of Test

The conditions and methods of test shall be in accordance with this specification and the Detail Specification.

The visual examination shall be in accordance with MIL-PRF-39012 specification.

4.1.3 Manufacturer's Responsibility for performance of Tests and Inspections

The manufacturer shall be responsible for the performance of tests and inspections required by the applicable specifications. These tests and inspections shall be performed at manufacturer premises.

4.2 DELIVERABLE COMPONENTS

Components delivered to this specification shall be processed and inspected in accordance with the relevant Product Quality Plan (PAQ). Each delivered component shall be traceable to its production lot. Components delivered to this specification shall have completed satisfactorily all tests to the testing level specified in the purchase order.

4.2.1 Lot failure

Lot failure may occur during Final Production Tests (Chart II), Qualification Testing (Chart IV) or lot Acceptance Testing (Chart V).

Should such failure occur during procurement, the manufacturer shall notify the Orderer in writing within 5 working days, giving details of the number and mode of failure and the suspected cause.

4.2.2 Testing and Lot Acceptance Levels

This specification defines the testing severity and the different tests applicable to the components (see Chart I).

For Lot Acceptance testing, 3 levels are possible (see Chart V). The Lot Acceptance levels are designated 1, 2 and 3 and are comprised of tests as follows :

- Level 3 (LAT3): None.
- Level 2 (LAT2): Electrical and Endurance Subgroup plus Quality Assurance Subgroup.
- Level 1 (LAT1): Environmental and Mechanical Subgroup plus Electrical and Endurance Subgroup plus Quality Assurance Subgroup.

The Lot Acceptance level shall be specified in a purchase order.

4.3 MARKING

All components, procured and delivered to this specification shall be marked in accordance with Radiall detail specification.

4.4 MATERIALS AND FINISHES

All non-metallic materials and finishes, that are not within a hermetically sealed enclosure, of the components specified herein shall meet the outgassing requirements as outlined in ECSS-Q-70-02. Specific requirements for materials and finishes are specified in the Detail Specification.

	GENERIC SPECIFICATION		
	REF. : RAD-GEN-CONN-001		
	Date: September 21 st , 17	ED/REV: 2 -	PAGE: 8 / 33

5. PRODUCTION CONTROL

5.1 GENERAL

The minimum requirements for production control, which are equally applicable to procurement, are defined in MIL-PRF 39012 specification.

5.2 SPECIAL IN-PROCESS CONTROLS

All the piece parts are selected from manufacturing lots coming from RADIALL standard production. Before assembly, the different elements of the connectors shall be submitted to the following controls.

5.2.1 Contact Engagement and Separation Forces

A sample of female centre contacts shall be checked for contact engagement and separation forces as defined in Para. 9.3.1 of this specification. The sample shall be selected in accordance with level S-4 of IEC Publication N° 60410, AQL 1.0.

5.2.2 External Visual Inspection

The sample shall be selected in accordance with level S-4 of IEC Publication N° 60410, AQL 1.0. Visual inspection shall be performed in accordance to MIL-PRF-39012.

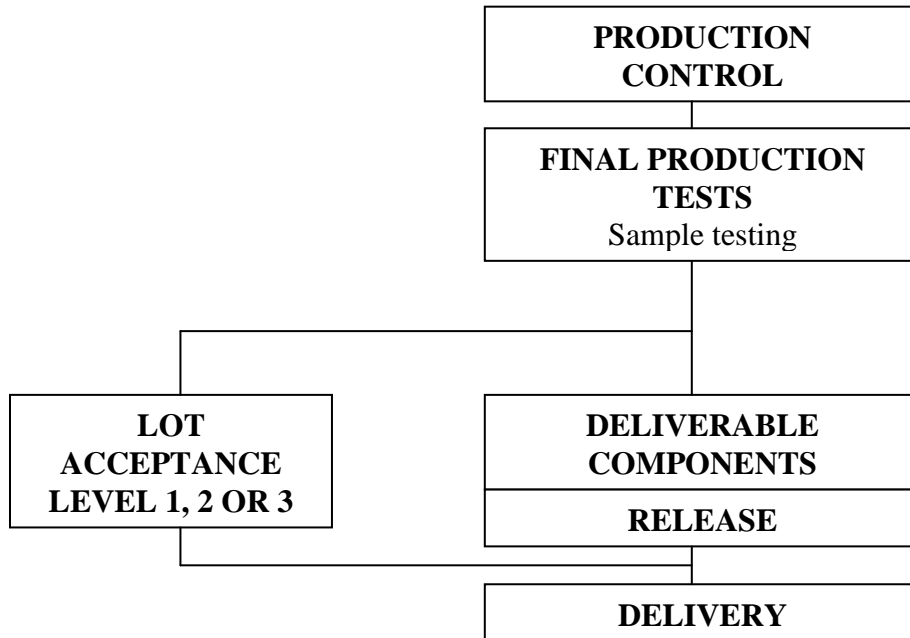
CHART I - TESTING LEVELS

	GENERIC SPECIFICATION		
	REF. : RAD-GEN-CONN-001		
	Date: September 21 st , 17	ED/REV: 2 -	PAGE: 10/ 33

6. FINAL PRODUCTION TESTS

6.1 GENERAL

Unless otherwise specified in the Detail Specification, all components used for qualification testing and all components for delivery including those submitted to lot Acceptance tests shall be subjected to tests and inspections in accordance with Chart II.

Unless otherwise specified in the Detail Specification, the tests shall be performed in the order shown. Any components that do not meet requirements shall be removed from the lot and at no future time be re-submitted to the requirements of this specification.

The samples shall be selected in accordance with Chart II. If one or more defects are found, the lot shall be screened for that particular defect and defects parts removed. A new sample of parts shall be selected in accordance with Chart II and all final production tests performed again.

If one or more defects are found in the second sample; the lot shall be rejected.

6.2 TEST METHODS AND CONDITIONS

The applicable test methods and conditions are specified in the paragraphs referenced in Chart II of this specification.

6.3 FAILURE CRITERIA

6.3.1 Parameter Limit Failure

A component shall be counted as a limit failure if 1 or more parameters exceed the limits shown in Table 2 of the Detail Specification. Any component, which exhibits a limit failure prior to the final production test sequence, shall be rejected, but not counted when determining lot rejection.

6.3.2 Other failures

A component shall be counted as a failure in any of the following cases :

- (a) Mechanical failure
- (b) Handling failure
- (c) Lost component

6.4 FAILED COMPONENTS

A component shall be considered as a failed component if it exhibits 1 or more of the failure modes described in Para. 6.3 of this specification.

6.5 LOT FAILURE

In case of lot failure, the Manufacturer shall act in accordance with the requirements specified in paragraph. 4.2.1 of this specification.

6.5.1 Lot failure during Sample Testing

A lot shall be considered as failed if the number of allowable failures during sample testing, selected in accordance with General Inspection Level II of IEC Publication N° 60410 with the applicable AQL, as specified in the Detail Specification, is exceeded. However, a 100% inspection may be performed.

6.6 DOCUMENTATION

Data documentation of Final Production Test data shall accordance with the requirements of Para. 10.6 of this specification.

	GENERIC SPECIFICATION		
	REF. : RAD-GEN-CONN-001		
	Date: September 21 st , 17	ED/REV: 2 -	PAGE: 11/ 33

7. BURN-IN AND ELECTRICAL MEASUREMENTS (CHART III)

Not applicable.

8. QUALIFICATION APPROVAL AND LOT ACCEPTANCE TESTS

8.1 QUALIFICATION TESTING

8.1.1 General

Qualification testing shall be in accordance with the requirements of Chart IV of this specification. The tests to Chart IV shall be performed on the specified sample, chosen at random from components, which have successfully passed the tests in Chart II. This sample constitutes the Qualification Test lot.

The Qualification Test lot is divided into subgroups and all components assigned to a subgroup shall be subjected to the entire test in that subgroup, in the sequence show.

Components shall be serialised prior to Chart IV testing.

The applicable test requirements are detailed in the paragraphs referenced in Chart IV.

8.1.2 Distribution within the Qualification Test Lot

A sample of 32 connector pairs shall be submitted to qualification testing (Chart IV).

Where a Detail Specification covers a range or series of components that are considered similar. Then the qualification test lot shall be comprised of component types so selected that they adequately represent all of the various mechanical, structural and electrical peculiarities of the procured range or series.

The selected distribution shall be agreed by the Orderer.

8.2 LOT ACCEPTANCE TESTING

8.2.1 General

The sample sizes of the 2 lot acceptance levels are specified in Chart V.

All components assigned to a subgroup shall be subjected to all of the tests of that subgroup in the sequence shown.

The test of Chart V shall be performed on the specified sample which shall have been chosen.

The applicable test requirements are detailed in the paragraphs referenced in Chart V.

8.2.2 Distribution within the Sample Lot for Lot Acceptance Testing

Where a Detail Specification covers a range or series of components that are considered similar, then it may be necessary that the sample for lot acceptance testing be comprised of component types so selected that they adequately represent all of the various mechanical, structural and electrical peculiarities of the procured range or series.

The distribution of the component types will normally vary from procurement to procurement and shall be specified by the Orderer.

8.2.3 Lot Acceptance Level 3 Testing (LAT3)

No tests or inspections are required for this level.

8.2.4 Lot Acceptance Level 2 Testing (LAT2)

For the Electrical and Endurance Subgroup, the following shall apply :

- (a) Components, selected from the Electrical an Endurance Subgroup, shall be serialised prior to the tests.
- (b) The tests in this subgroup are considered to be destructive and therefore components so tested shall not form part of the delivery lot.

	GENERIC SPECIFICATION		
	REF. : RAD-GEN-CONN-001		
	Date: September 21 st , 17	ED/REV: 2 -	PAGE: 12/ 33

8.2.5 Lot Acceptance Level 1 Testing (LAT1)

Lot Acceptance Level 1 Testing shall comprise the tests for LAT2 (Electrical and Endurance Subgroup) plus tests on an Environmental and Mechanical Subgroup. For the Quality Assurance, Electrical and Endurance Subgroups, the requirements and conditions for LAT2 (see Para. 8.2.3) respectively shall apply.

For the Environmental Subgroup, the following shall apply :

- (a) Components, selected from the Electrical and Endurance Subgroup, shall be serialised prior to the tests.
- (b) The tests in this subgroup are considered to be destructive and therefore components so tested shall not form part of the delivery lot.

8.3 FAILURE CRITERIA

The following criteria shall apply to Qualification testing and to Lot Acceptance testing.

8.3.1 Environmental and Mechanical Test Failures

The following shall be counted as component failures; components, which fail during tests for which the pass/fail criteria are inherent in the test method, e.g. soldering, proof, etc...

8.3.2 Electrical failures

The following shall be counted as component failures :

- (a) Components which, when submitted to Electrical Measurements on Completion of Environmental Tests in accordance with either Table 2 or Table 6, as specified in the Detail Specification, fail 1 or more of the applicable limits.
- (b) Components which, when subjected to Electrical Measurement at Intermediate and End-Points during Endurance Testing, in accordance with Table 6 of the Detail Specification, fail 1 or more of the applicable limits.
- (c) Components which, when subjected to Measurement of Electrical Characteristics, in accordance with Table 2 of the Detail Specification, fail 1 or more of the applicable limits.

8.3.3 Other failures

The following additional failures may also occur during Qualification testing or lot Acceptance testing

- (a) Components failing to comply with the requirements of MIL-PRF-39012 Specification.
- (b) Lost components.

8.3.4 Major failures

The failure is considered as major if:

- Mechanical integrity of the connector is involved
- RF transmission function is not ensured any more.

8.4 FAILED COMPONENTS

A component shall be considered as failed if it exhibits 1 ore more of the failure modes detailed in paragraph. 8.3 of this specification. The allowable number of failed components per subgroup, the aggregate failure constraints and the permitted distribution of such failures are shown at the foot of Charts IV and V of this specification.

When requested by the Order, failure analysis of failed components shall be performed by the Manufacturer, and the results provided.

	GENERIC SPECIFICATION		
	REF. : RAD-GEN-CONN-001		
	Date: September 21 st , 17	ED/REV: 2 -	PAGE: 13/ 33

8.5 LOT FAILURE

A lot shall be considered as failed if the allowable number of failures according to Chart IV or V of this specification, as relevant, has been exceeded.

In the case of lot failure, the Manufacturer shall act in accordance with paragraph. 4.3.1 of this specification.

8.6 DOCUMENTATION

For qualification testing, the qualification test data shall be documented in accordance with the requirements of Para. 10.8 of this specification. In the case of lot acceptance testing, the data shall be documented in accordance with the requirements of paragraph. 10.9.

CHART II - FINAL PRODUCTION TESTS

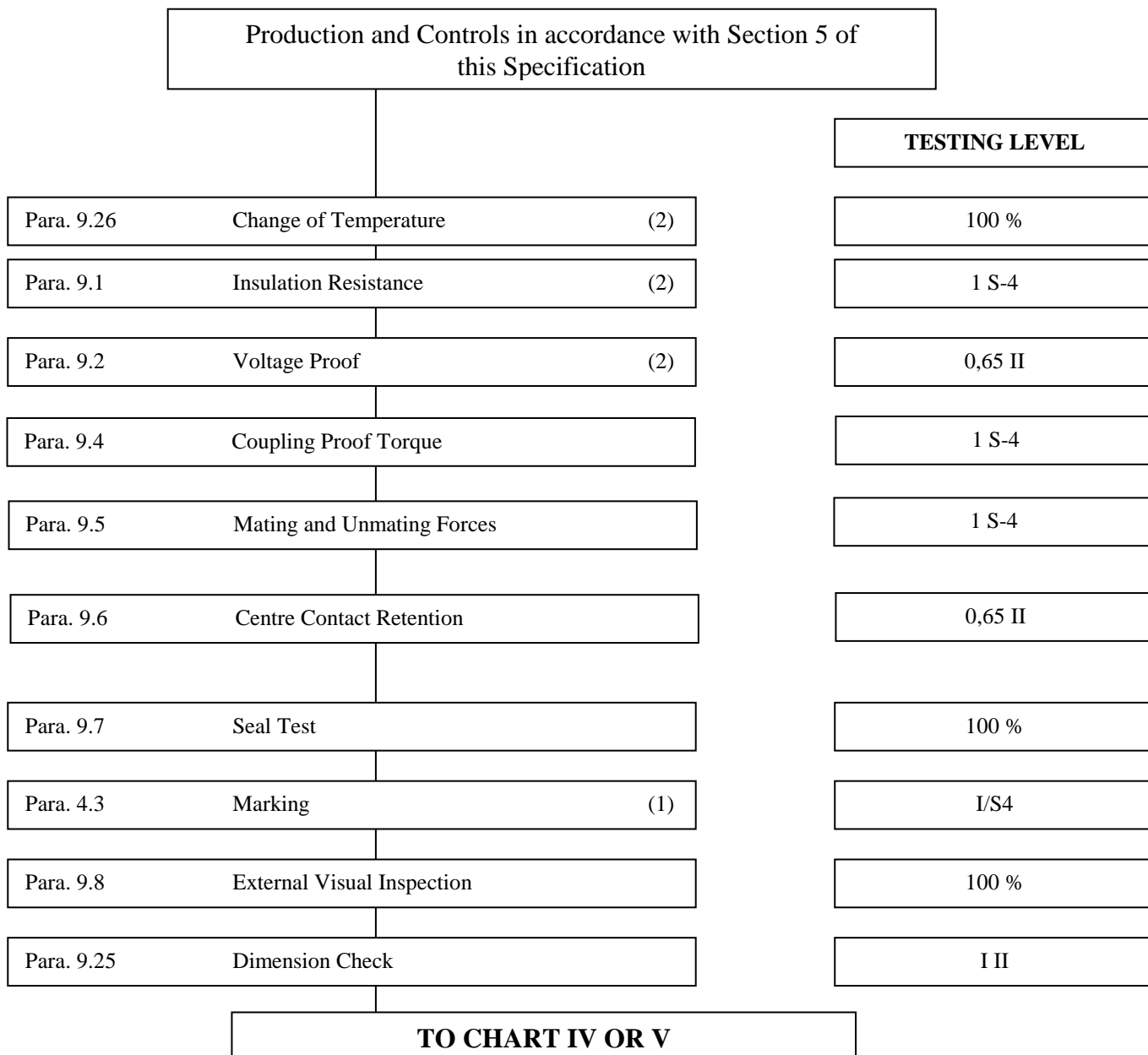

NOTES:

1. Marking may be performed at any point in the sequence.
2. Not applicable to Variants where the centre contact and insulator are not mounted in the connector for delivery.

CHART III - BURN-IN AND ELECTRICAL MEASUREMENTS (Not applicable)

Not Applicable

CHART IV - QUALIFICATION TESTS

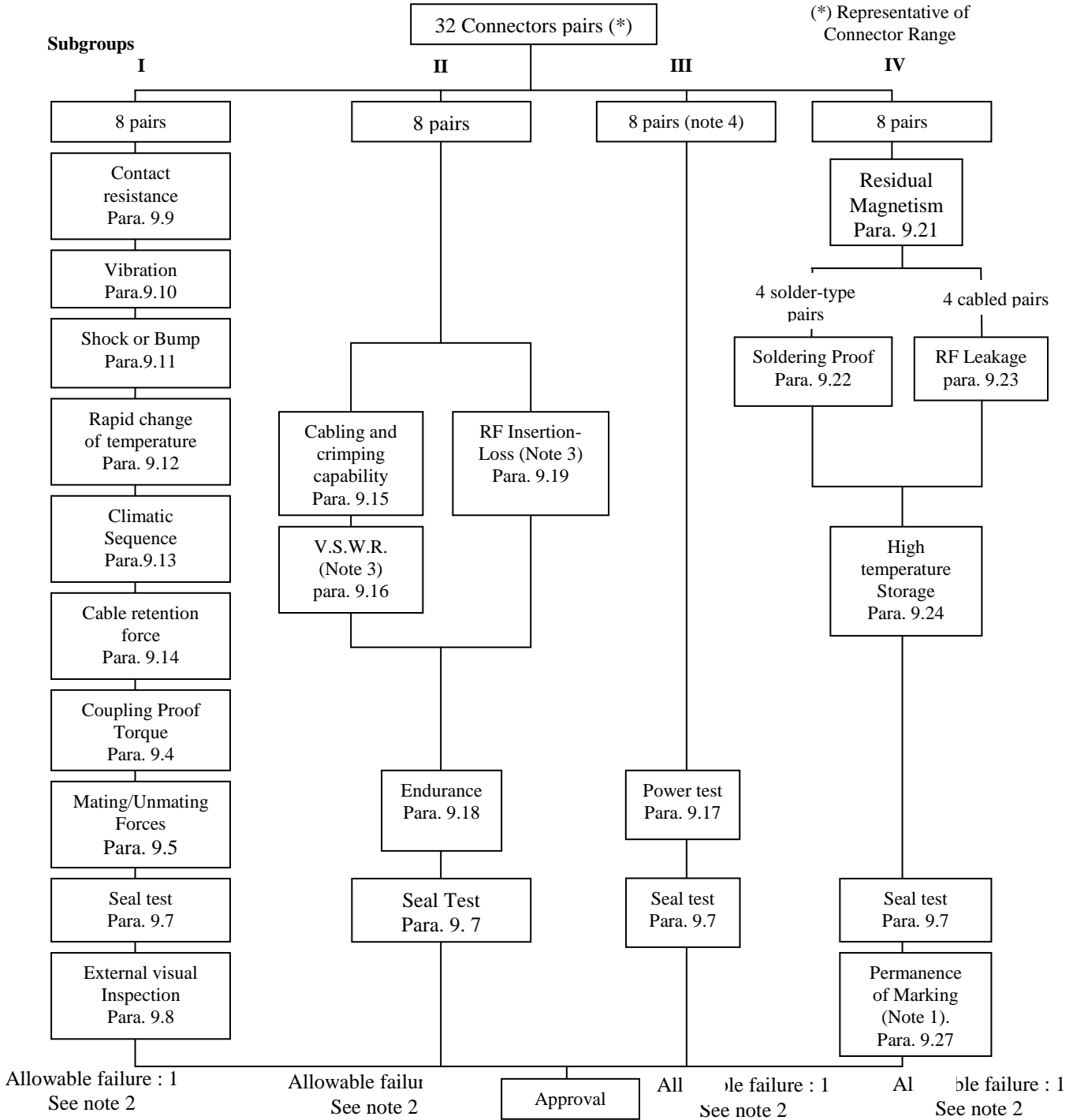

NOTES:

1. Not applicable to engraved parts.
2. Allowable number of failed components: major failure = 0, other failure = 2 on the totality of the Chart IV with a maximum of 1 by sub-group.
3. RF Insertion loss measurement will be performed using cable assemblies previously submitted to the VSWR measurement.
4. Applicable only for Power connectors (if ordered, it is an option)

CHART V – LOT ACCEPTANCE TESTS

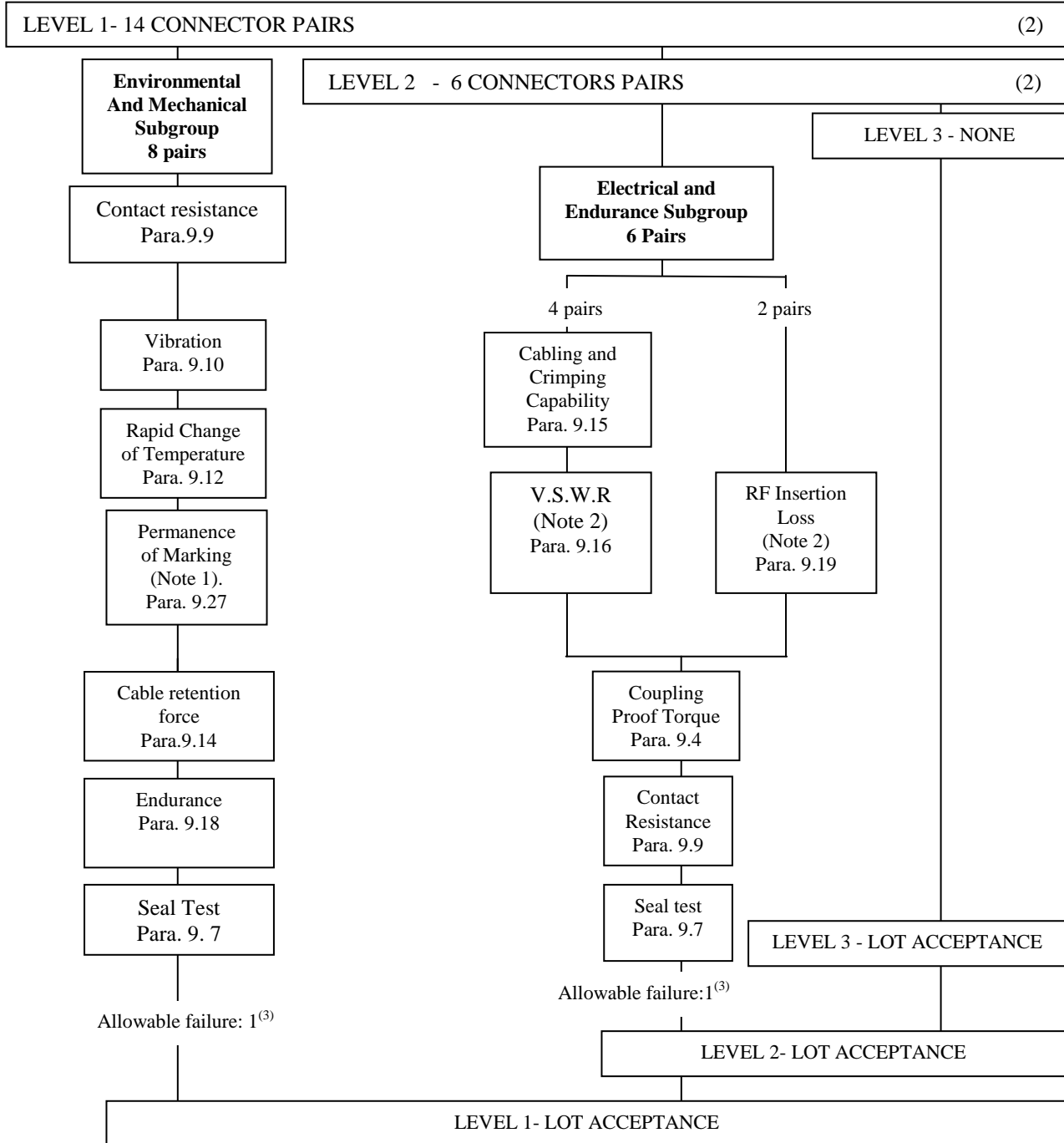

NOTES:

1. Not applicable to engraved parts.
2. RF Insertion loss measurement will be performed using cable assemblies previously submitted to the VSWR measurement.
3. Allowable number of failed components: major failure = 0, other failure = 1 on the totality of the Chart IV with a maximum of 1 by sub-group.

	GENERIC SPECIFICATION		
	REF. : RAD-GEN-CONN-001		
	Date: September 21 st , 17	ED/REV: 2 -	PAGE: 17/ 33

9. TEST METHODS AND PROCEDURES

9.1 INSULATION RESISTANCE

The insulation resistance shall be measured on the uncabled connectors between the centre contact and the body under a voltage of 500 Vdc. The measurements shall be read after 1 minute of voltage application.

9.2 DIELECTRIC WITHSTANDING VOLTAGE

The connectors shall be tested under the following conditions:

- (a) The maximum relative humidity shall be 50%.
- (b) Precautions shall be taken to prevent air-gap breakdowns.
- (c) The test voltage specified in Table 2 of the Detail Specification shall be applied instantaneously.
- (d) The points of application of the test voltage shall be between the centre contact and the shell of the uncabled connectors.
- (e) The duration of application of the test voltage shall be 1 minute.
- (f) The leakage current shall be lower than specified in Table 2 of the Detail Specification.

9.3 CONTACT ENGAGEMENT AND SEPARATION FORCES

9.3.1 *In-process Control*

The female contact shall be tested as follows.

A force, which is gradually increased, shall be applied with force speed not exceeding 1 mm/second until the steel test pin properly engages with, or separated from, the female connectors. The polished steel test pins shall be defined in the Detail Specification. The oversize test pin shall be engaged and separated from each female contact 3 times. Then, the engagement force shall be measured with the maximum diameter test pin. Subsequently, the minimum diameter test pin shall be engaged and separated once to measure the withdrawal force. The engagement and separation forces shall meet the requirements of the Detail Specification.

9.4 COUPLING PROOF TORQUE

The connector shall be engaged with its mating counterpart (gauge) and the coupling nut tightened to the torque specified in the Detail Specification. After 1 minute, the connector pair shall be disconnected. The coupling mechanism shall not be dislodged and the interface dimensions of the connector shall remain as specified in the Detail Specification.

9.5 MATING AND UNMATING FORCES

9.5.1 *Bayonet and Screw coupling*

The connector shall be mated with its mating gauge. During the entire mating or unmating cycle (until the connector is fully mated or unmated), the necessary torque shall not exceed the value specified in the Detail Specification.

A screw-coupling connector is fully mated with its mating gauge when their reference planes coincide.

A bayonet-coupling connector is fully mated with its mating gauge when the bayonet studs have passed the detent and their reference planes coincide.

No additional tightening torque shall be applied.

The gauge is a steel jig containing the critical interface dimensions specified in the Detail Specification.

9.5.2 *Push-pull coupling*

The connector under test shall be mated with its mating gauge. During this engaging cycle, the force necessary to fully mate the connectors shall not exceed the value specified in the Detail Specification. Upon completion of mating, an opposite force necessary for unmating shall be applied. This force shall be within the limits specified and include any unmating forces required.

9.6 CENTRE CONTACT RETENTION

Axial and rotational forces as specified in the Detail Specification shall be applied, first in one direction and then in the other, to the centre contact of an assembled and uncabled connector, using an appropriate method. The inner contact shall be inspected after the forces have been applied in one direction and again after the forces have been applied in the opposite direction to determine if the contact has been displaced from the specified interface dimensions.

9.7 SEAL TEST

9.7.1 Hermetically Sealed Connectors

The leakage rate shall not exceed 10^{-8} cubic centimetres per second of helium under a vacuum of 10^{-5} Torr.

9.7.2 Leakage (Barrier-sealed Connectors)

Connectors shall be subjected to an air pressure of 2.1 kg/cm² applied to one end, and the whole assembly immersed in water or isopropyl alcohol at a temperature of +15 to +25°C.

The connectors shall remain immersed for 2 minutes maximum and there shall be no bubbles emanating from the other end.

9.7.3 Leakage (Panel-sealed Connectors)

Panel-sealed specimens shall be mounted in a normal manner in a suitable test jig. The mating end of the connectors shall be sealed with the appropriate mating connector and the whole assembly immersed in water or isopropyl alcohol at a temperature of +15 to +25°C.

An air pressure of 2,1 kg/cm² shall be applied to one end of the assembly for 2 minutes maximum, and there shall be no bubbles emanating from the connectors.

9.8 EXTERNAL VISUAL INSPECTION

External visual inspection shall be performed according to MIL-PRF 39012 specification.

9.9 CONTACT RESISTANCE

9.9.1 Method A – Using Separate Power Supplies and Meters

The measurement shall be performed in accordance with Figure 1 (a). The contact resistances to be measured are:

- (a) The contact resistance of the mated inner conductor contacts.
- (b) The contact resistance of the mated outer conductor contacts (if possible, the coupling nut shall be removed for this measurement).
- (c) For cabled connectors, the contact resistance between the cable braid or outer conductor and the connector at the point of contact.

The test current, voltage and contact resistance limits shall be as specified in table 6 of the Detail Specification.

9.9.2 Method B – Using Integrated Power Supplied and Meters with a 4 Terminal Bridge Arrangement

9.9.2.1 Equipment

The milliohmeter shall have the following characteristics :

Maximum Potential across sample :	20mV
Maximum Measuring Frequency :	2KHz
Minimum Accuracy :	± 2% of requirement
Maximum Applied Current :	50mA rms.

9.9.2.2 Centre contacts

- (a) Connect the Kelvin clips to the inner conductors of the mated pair of connectors as show in Figure I (b).
- (b) Record the value of contact resistance.
- (c) Reverse the connections.
- (d) Record the value of contact resistance.
- (e) Calculate the average value of the 2 measurements from (b) and (d) above.

The average value of the contact resistance shall not exceed the limits specified in Table 6 of the Detail Specification.

9.9.2.3 Outer contacts

Repeat the procedure of 9.9.2.2 above, but connect the Kelvin clips to the 2 outer conductors close to the interface plane as shown in Figure I (b).

FIGURE I (a) – CONTACT RESISTANCE MEASUREMENTS – METHOD A

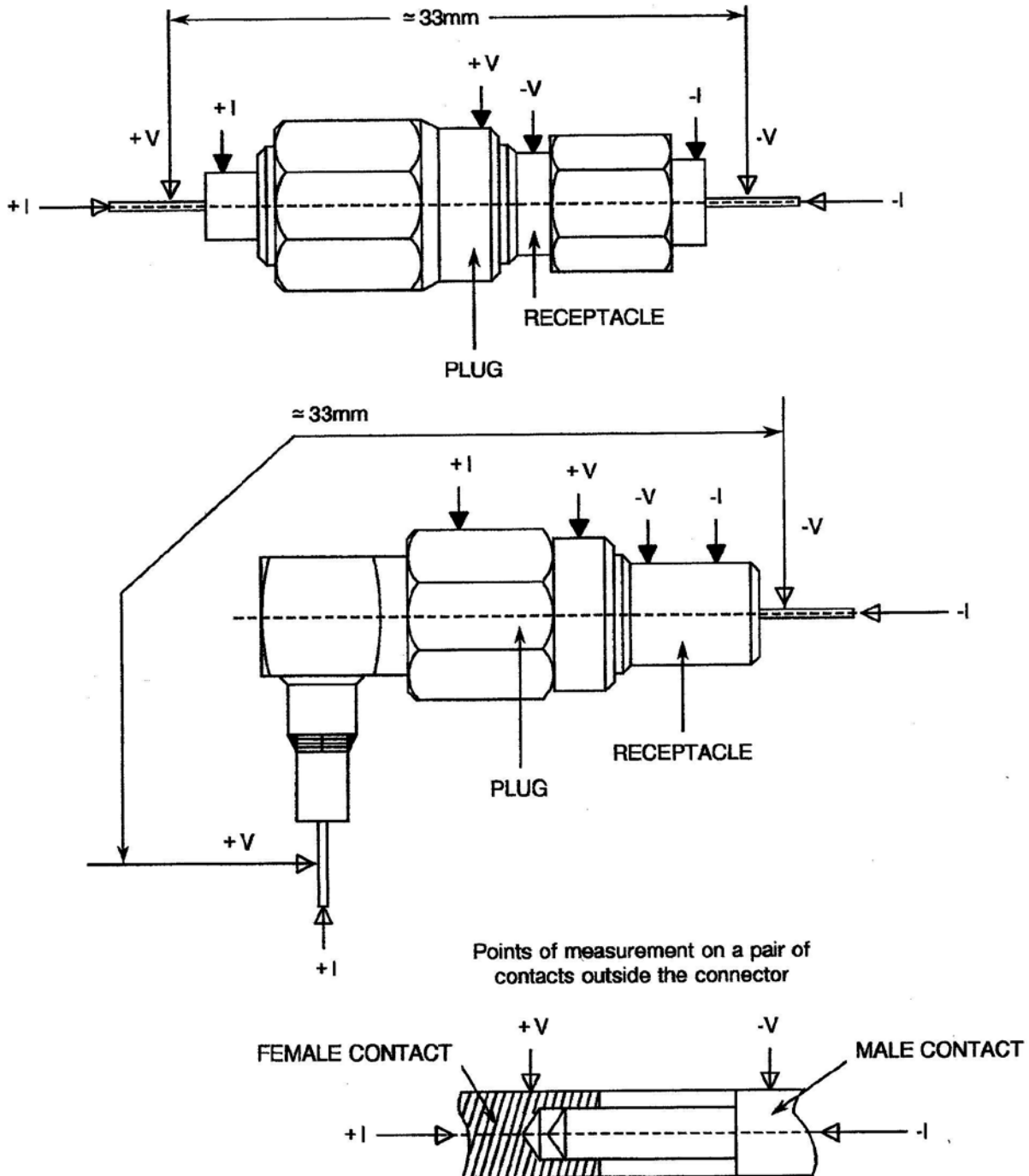

NOTES:

1. Points of measurement on mated pairs of connectors.
The white arrows show probe positions for measuring contact resistance of the centre contact.
The black arrows show probe positions for measuring contact resistance of the outer contact.

FIGURE I (b) – CONTACT RESISTANCE MEASUREMENT – METHOD B

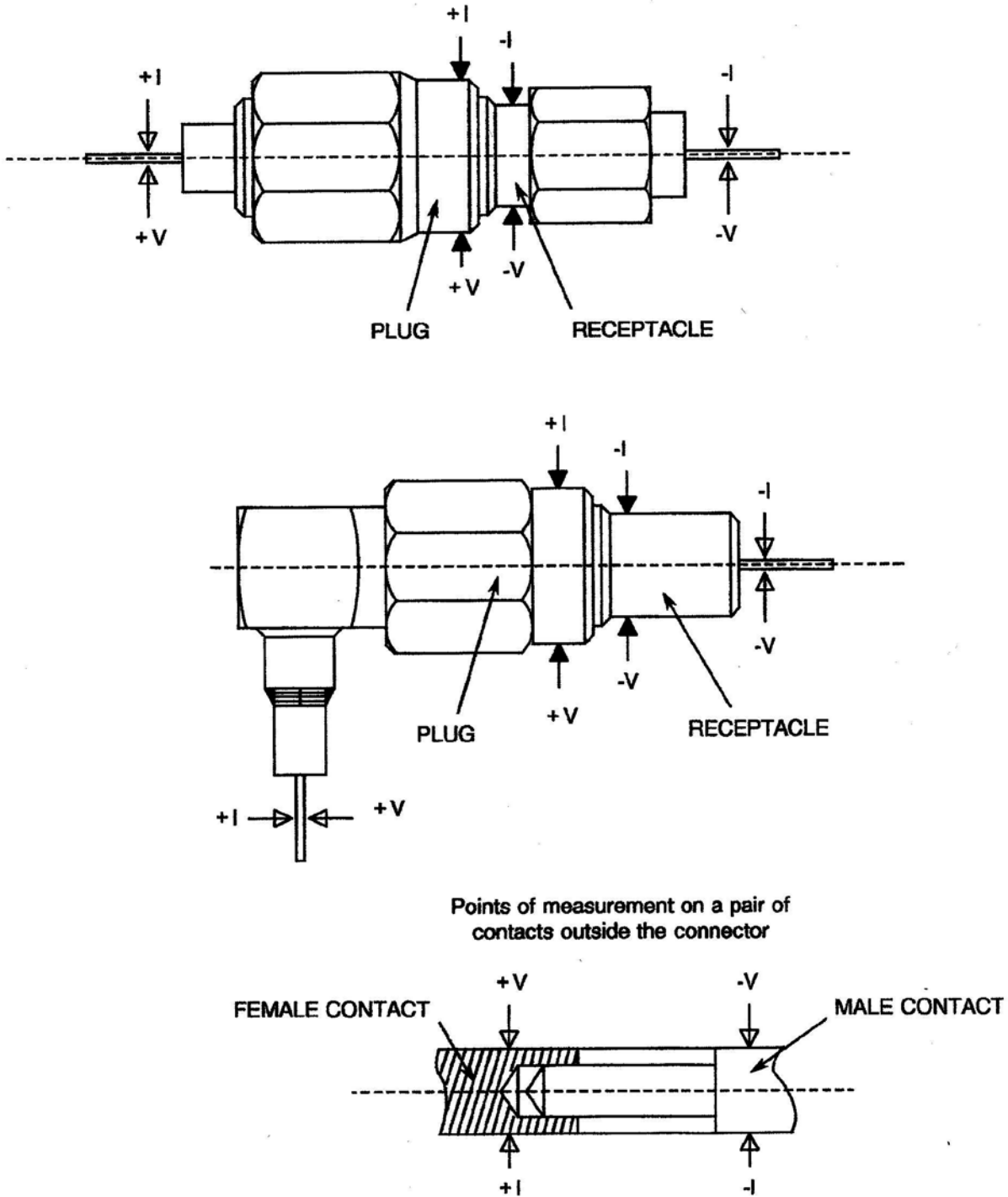

NOTES:

1. Points of measurement on mated pairs of connectors.
The white arrows show probe positions for measuring contact resistance of the centre contact.
The black arrows show probe positions for measuring contact resistance of the outer contact.

	GENERIC SPECIFICATION		
	REF. : RAD-GEN-CONN-001		
	Date: September 21 st , 17	ED/REV: 2 -	PAGE: 22/ 33

9.10 VIBRATION

9.10.1 Mounting

The specimens shall be mechanically connected to the vibration generator either directly or by means of a fixture as specified below. Mounting fixtures shall be such that they enable the specimen to be vibrated in 3 mutually perpendicular axes in turn, which should be so chosen that fault are most likely to be revealed.

If the component is provided with specific means of mounting, they shall be used as specified in the Detail Specification and any additional restraining straps should be avoided.

Unless otherwise specified, components not provided with specific mounting means shall be clamped by the body.

If external connections, necessary for measuring and supply purposes, are specified in the Detail Specification, they should add the minimum restraint and mass.

9.10.2 Procedure

The components shall be subjected to Test Fc of IEC Publication N° 60068-2-6, Procedure B4. Sweep frequency: 10-2000-10 Hz. The entire frequency ranges of 10 to 2000 Hz and return to 10 Hz shall be traversed in 10 minutes.

This cycle shall be performed 12 times in each of the 3 directions (i.e. 36 times in total), so that the motion is applied for a total period of approximately 6 hours. The vibration shall be 1.5 mm (total display) or 30 g, whichever is smaller.

9.10.3 Measurement during Vibration

During the last cycle in each direction an electrical measurement shall be made to determine intermittent contact of 10ms or longer duration, or open on short-circuiting. At least 100mA shall be flowing through each set of contacts. Contacts may be connected in series.

9.10.4 Final Measurements

After vibration, the components shall be visually inspected and there shall be no evidence of damage.

Measurements as specified in Table 6 of the Detail Specification shall be performed and shall not exceed the specified limits.

9.11 SHOCK OR BUMP

9.11.1 Shock

9.11.1.1 Mounting

The specimens shall be fixed to the shock machine, either directly or by means of a fixture as specified below. Mounting fixtures shall enable the specimens to be subjected to shocks in 3 mutually perpendicular axes in turn. When the component is provided with specific mounting means, these shall be used as specified in the Detail Specification and any additional restraining straps should be avoided.

Unless otherwise specified, components not provided with specific mounting means shall be clamped by the body. When external connections, necessary for measuring and supply purposes, are specified in the Detail Specification, they should add the minimum restraint and mass.

9.11.1.2 Procedure

The components shall be subjected to Test Ea of IEC Publication N° 60068-2-27. Unless otherwise specified in the Detail Specification, the following conditions shall apply :

- Shape of shock pulse: Saw-tooth
- Peak acceleration: 100 g
- Duration of pulse: 6 ms
- Number of shocks: 18 (3 shocks in each direction in the 3 perpendicular axes of the test specimen).

9.11.1.3 Visual inspection

After shock, the components shall be visually examined and there shall be no evidence of damage.

Measurements as specified in Table 6 of the Detail Specification shall be performed and shall not exceed the specified limits.

9.11.2 Bump

9.11.2.1 Mounting

As specified in Para. 9.11.1.1, the word “shock” to be replaced by “bump”.

9.11.2.2 Procedure

The components shall be subjected to Test Eb of IEC Publication N° 60068-2-29. Unless otherwise specified in the Detail Specification, the following conditions shall apply :

- Peak acceleration: 390m/s²
- Number of bumps: 4000 ± 10

9.11.2.3 Visual inspection

After bump, the components shall be visually examined and there shall be no evidence of damage. Measurements as specified in Table 6 of the Detail Specification shall be performed and shall not exceed the specified limits.

9.12 **RAPID CHANGE OF TEMPERATURE**

9.12.1 Initial measurements

None.

9.12.2 Procedure

The components shall be subjected to Test Na of IEC Publication N° 60068-2-14 with 30 minutes at each extreme temperature as specified in the Detail Specification (Figure 2(b) – Variants).

9.12.3 Recovery and Final Measurements

The duration of recovery shall be 24 ± 2 hours at room temperature conditions. After recovery, the components shall be visually examined and there shall be no evidence of damage, Measurements as specified in Table 6 of the Detail Specification shall be performed and shall not exceed the specified limits.

	GENERIC SPECIFICATION		
	REF. : RAD-GEN-CONN-001		
	Date: September 21 st , 17	ED/REV: 2 -	PAGE: 24/ 33

9.13 CLIMATIC SEQUENCE

Mated connector pair shall be submitted to the following.

9.13.1 Initial Measurements

No initial measurements are required.

9.13.2 Dry heat

Not applicable.

9.13.3 Damp heat, accelerated, First cycle

Unless otherwise specified in the Detail Specification, the components shall be subjected to Test “Db”. Variant 02 of IEC Publication N° 60068-2-30 for 1 cycle of 24 hours. After recovery, the components shall be subjected immediately to the cold test.

9.13.4 Cold test

The components shall be subjected to Test “Aa” of IEC Publication N° 60068-2-1. Duration: 2 hours. Minimum storage temperature as prescribed in the Detail Specification (Table 1(b)).

9.13.5 Low Air Pressure

The components shall be subjected to Test “M” of IEC. Publication N° 60068-2-13 under the following conditions :

- 5 minutes at 44mBar.
- Temperature: + 15 to + 35°C.

Dielectric withstanding voltage as per Table 1 (b) of the Detail Specification shall be applied for 5 minutes immediately after the pressure of 44mBar has been attained. There shall be no evidence of flashover or breakdown.

9.13.6 Damp heat, Accelerated, Remaining Cycles

The components shall be subjected to Test “Db”, Variant 2 of IEC Publication N° 60068.2.30 for 5 cycles of 24 hours.

9.13.7 Final measurements

After a recovery period of 1 to 24 hours, the components shall be visually inspected according to MIL-PRF 39012 specification and there shall be no evidence of mechanical damage. Measurements as specified in Table 6 of the Detail Specification shall be performed and shall not exceed the specified limits.

9.14 **CABLE RETENTION FORCE (cable connectors only)**

- (a) The connector shall be assembled to its test cable as specified in the Detail Specification. It shall be firmly fixed and a movable sleeve attached to the cable. The sleeve shall then be moved away from the fixed connector longitudinally and gradually, and in such a manner that the cable remains unbent and untwisted. A scale for measuring the retention force (see Detail Specification) shall be attached to the sleeve. The force shall be maintained for 30 seconds minimum.
- (b) The assembly, still under tension, shall be tested for continuity, using a simple low voltage lamp circuit, and shall then be examined for mechanical failure, loosening or rupture.
- (c) With the connector still in the fixed position, the cable shall be held at a point 50 times the diameter of the cable from the connector and a torque shall be applied in both directions as specified in the Detail Specification.
- (d) This test is only application to connectors designed to accept flexible cables. The cable shall then be bent at a radius of 10 times the diameter of the cable, starting at the connector, at an angle of $90 \pm 5^\circ$ from the axis of the connector, then reversed $180 \pm 10^\circ$.

This procedure shall be repeated 4 times prior to re-test and re-examination as specified in point (b) above.

	GENERIC SPECIFICATION		
	REF. : RAD-GEN-CONN-001		
	Date: September 21 st , 17	ED/REV: 2 -	PAGE: 25/ 33

9.15 CABLING AND CRIMPING CAPABILITY (cable connectors only)

The solderability test Ta of IEC Publication N° 60068-2-20 shall be performed on parts to be soldered as applicable (Method 2, size B).

The connector shall be assembled and crimped or soldered to the cable as specified in the Detail Specification, using the manufacturer's approved crimping tools and cabling procedure.

There shall be 2 cable assemblies with male connectors at each end and 2 cable assemblies with female connectors at each end. These 4 cable assemblies shall have identical lengths. These cable assemblies shall be equipped with identical male connectors or identical female connectors when the scalar measurement method is chosen.

- (a) The assembly shall be carried out without particular difficulty (for crimp-connectors only).
- (b) The crimps shall be examined under X10 magnification and shall be free from cracks.
- (c) Solder joints shall be examined under X10 magnification, They shall be bright and show a good wetting.
- (d) Interface and external dimensions shall conform to those shown in Figure 2 of the Detail Specification.
- (e) Insulation resistance and dielectric withstanding voltage shall meet the requirements of the Detail Specification.

9.16 VOLTAGE STANDING WAVE RATIO (VSWR) OR REFLECTION COEFFICIENT

The reflection coefficient or VSWR shall be measured in accordance with one of the following methods :

- Scalar method (test set-up shown in Figure II (a))
- Vectorial method (test set-up shown in Figure II (b) or II (c))

Across the full frequency range by the swept frequency technique or, alternatively, at fixed frequencies, equally spaced points (7 minimum) across the frequency range. The measured values shall not exceed those given in the Detail Specification.

For flange mounted connectors, the rear part of the connector may be machined off to allow direct assembly of a coaxial test set-up to the rear part of the connector.

When the vectorial method is chosen, the VSWR or reflection coefficient of 1 connector is determined by using the temporal response (time domain) and a function called "GATE" to isolate the connector which must be connected to the standard precision adapter N°3 (see figure II (b) or II (c)). For the measurement of the other connector, the cable assembly must be reversed.

In the event of dispute, the vector method shall be used with the test set-up show in Figure II (b).

9.17 POWER TEST

This test will be done on the connector used under power (see Technical Data Sheet). The multipactor, power handling and corona test (if required) shall be performed according to Power test procedure..

9.18 ENDURANCE

Each connector under test shall be mated with a typical production mating connector as per this specification. The connector shall be submitted to the number of cycles of mating and unmating specified in the Detail Specification. The connector and its mating part shall be completely mated at the specified torque and completely unmated during this cycle. The threads of rotational parts shall not be lubricated for this test unless specified in the Detail Specification. It is permitted to shake or blow debris from the threads or interface surfaces at intervals of not less than 50 cycles. Solvents and tools shall **not** be used for cleaning.

After this test, the mating and unmating forces, centre and shell contact resistances shall be measured and shall meet the requirements of Table 6 of the Detail Specification. The connectors shall be visually examined and, except for contact and thread wear, shall show no evidence of physical damage.

FIGURE II (a) - SWEPT FREQUENCY TEST SET-UP – SCALAR METHOD

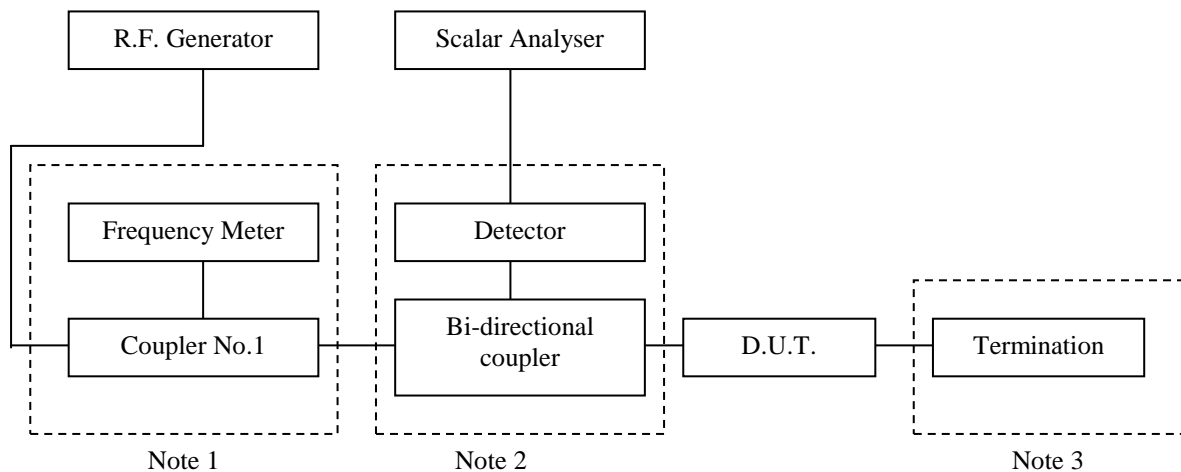

NOTES:

1. In the of swept frequency technique, the coupler No 1 and the frequency meter are optional
2. Or reflectometer bridge with a directivity better than 35dB
3. The reflection coefficient of the termination must be better than 0.017 (-35dB) in the test frequency range.

FIGURE II (b) - SWEPT FREQUENCY TEST SET-UP – VECTORIAL METHOD (2 PORTS)

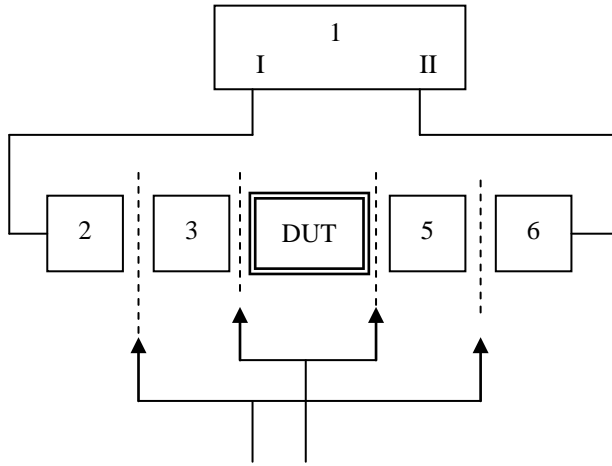

- 1 : Vector network with RF generator and S parameter test set.
- 2-6 : Cables assemblies.
- 3-5 : Standard precision adapters.

Possible calibration planes of full two ports calibration.

FIGURE II (c) - SWEPT FREQUENCY TEST SET-UP – VECTORIAL METHOD (1 PORT)

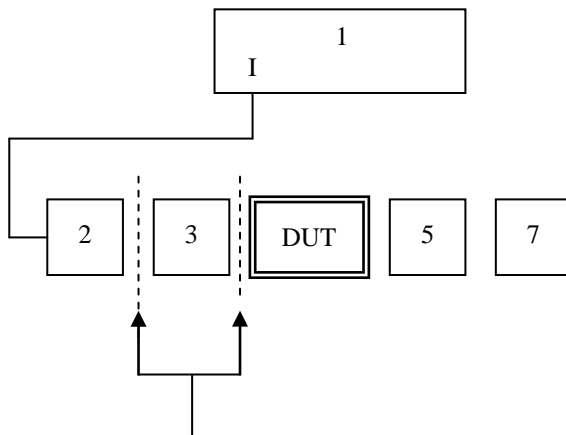

- 1 : Vector network with RF generator and S parameter test set.
- 2 : Cables assemblies.
- 3-5 : Standard precision adapters.
- 7 : Precision termination (reflection coefficient better than 0.017 (-35 dB) in the test frequency range).

Possible calibration planes of S11 calibration (reflection).

	GENERIC SPECIFICATION		
	REF. : RAD-GEN-CONN-001		
	Date: September 21 st , 17	ED/REV: 2 -	PAGE: 28/ 33

9.19 RF INSERTION LOSS

The connectors shall be tested as shown in Figure III (a) or III (b). Insertion loss of a mated connector set is defined as the increase of a loss due to insertion of a mated connector set in a cable. This includes the reflection losses to the cable and dissipating losses in the pair.

In the event of dispute, the vectorial method shall be used with the set-up shown in Figure III (b).

Procedure :

- For qualification tests (Chart IV): use 2 of the male cable assemblies and 2 of the 2 female cable assemblies from the VSWR measurement (cable assembly of Figure III (c)).
- For lot acceptance tests (Chart V): use 1 of the 2 male cable assemblies and 1 of the 2 female cable assemblies from the VSWR measurement (cable assembly of Figure III (c)).
- Measures the electrical length of the cable assembly (length L1) (a time reflectometer may be used to measure the electrical length).
- The equipment is calibrated. The insertion losses of the cable assembly are measured and the values are recorded.
- The connector pair is inserted at the point P of the cable assembly, as shown in Figure III (c), the length (L2) is adjusted so that the electrical length is identical to cable assembly to within $\lambda \text{ min}/20$ (min is the wavelength at the highest test frequency in the frequency range).
- The equipment is calibrated and the insertion losses of the cable assembly, including connector pair under test, are measured. The values are recorded.
- Subtract the insertion loss of cable assembly measured earlier to obtain the insertion loss of the connector pair.
- The insertion loss of 1 connector shall be the insertion loss of the connector pair divided by 2.
- Measurement shall be performed across the full frequency range by the swept frequency technique or, alternatively, at fixed frequencies, equally spaced points (7 minimum) across the frequency range.
- For flange mounted connectors, the rear part of the connector may be machined off to allow direct assembly of a coaxial test set-up to the rear part of the connector.

9.20 CORROSION

Not Applicable.

9.21 RESIDUAL MAGNETISM

After having been submitted to a magnetic field of 200 Gauss, the unwired connectors shall be placed 3 mm from the meter probe tip and oriented for a maximum reading. The measurement unit shall be gamma (1 gamma = 10^5 Gauss) and the value shall be as specified in the Detail Specification.

FIGURE III (a) – METHOD OF RF INSERTION LOSS MEASUREMENT OF MATED CONNECTORS

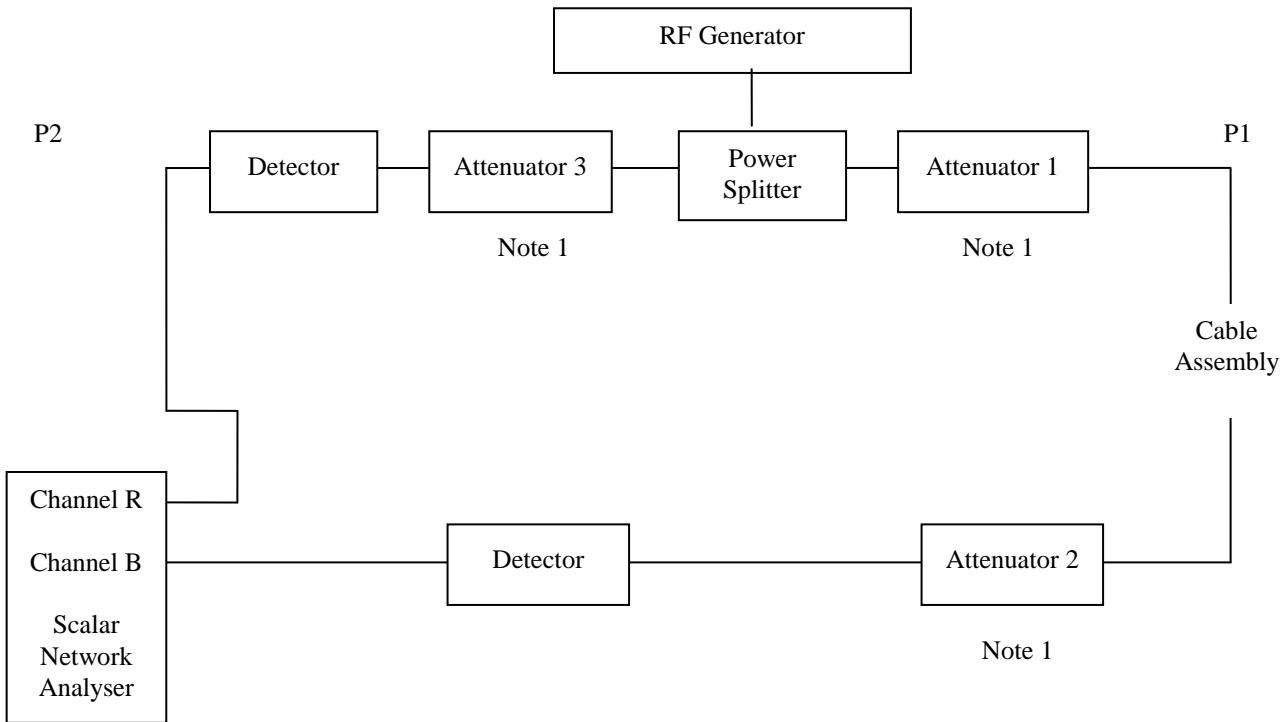

NOTES:

1. The attenuators 1, 2, 3 must be chosen so that the ratio of P1 to P2 is close to 1 (balanced power in the 2 arms of the test set-up).

The attenuators values must be large enough (6dB minimum) to cancel the reflections due to measurement accessories.

For example, selected attenuators might be as follows:

Attenuator 1 = 10 dB – Attenuator 2 = 10 dB – Attenuator 3 = 20 dB.

FIGURE III (b) – VECTOR METHOD OF RF INSERTION LOSS MEASUREMENT OF MATED CONNECTORS

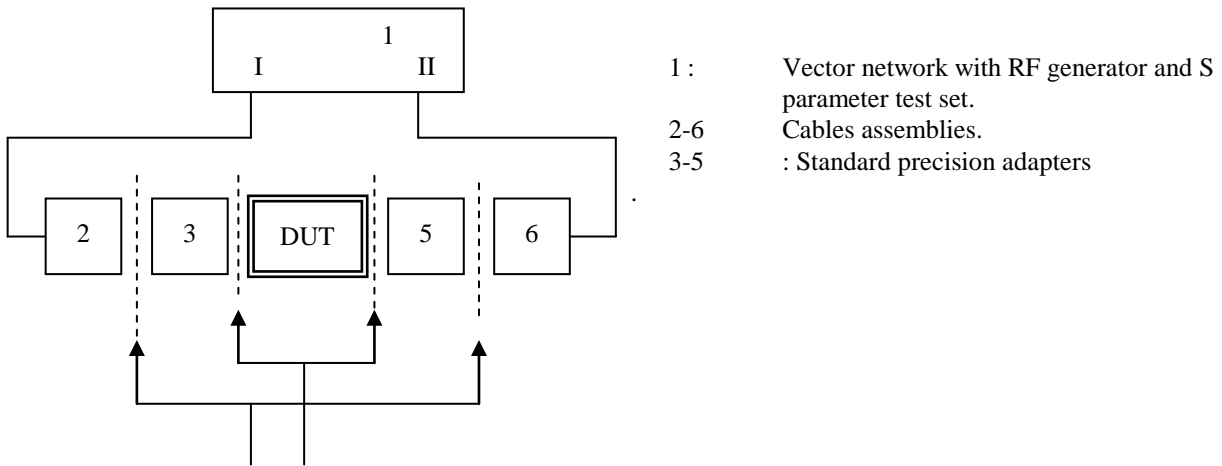

Possible calibration planes of full two ports calibration.

FIGURE III (c) – CABLE ASSEMBLY FOR RF INSERTION LOSS MEASUREMENT OF MATED CONNECTORS

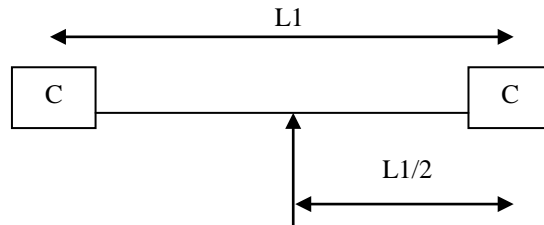

Point of insertion of connector pair to be measured.

NOTES:

1. The connector (c) at each end of the cable assembly must have a reflection coefficient better than 0.1 (-20 dB) in the test frequency range.
2. The connector pair to be measured must be inserted at the point P (distance = L1/2).

	GENERIC SPECIFICATION		
	REF. : RAD-GEN-CONN-001		
	Date: September 21 st , 17	ED/REV: 2 -	PAGE: 31/ 33

9.22 SOLDERING PROOF (Solder type connectors only)

The connectors shall be wired and soldered, using the approved manufacturer's procedures. The connectors shall then be inspected and shall meet the requirements of Table 6 of the Detail Specification.

9.23 RF LEAKAGE (Semi-rigid cable connectors only)

The mated connector pair shall be tested in reverberant chamber according to test method defined in IEC Publication N° 61726.

9.24 HIGH TEMPERATURE STORAGE

Mated connectors shall be submitted to a high temperature storage test in accordance with Test Ba of IEC Publication N° 60068.2.2 for 1000 hours.

Test temperature: maximum operating temperature as specified in the Detail Specification.

After the test, the connectors shall remain at room ambient temperature for 1 hour minimum and 2 hours maximum and shall meet the requirements of Table 6 of the Detail Specification.

A slight uniform discoloration of the parts is allowed.

9.25 DIMENSION CHECK

See MIL-PRF 39012 Specification and Figure 2 of the Detail Specification. If 1 failure occurs, the complete lot shall be checked.

9.26 CHANGE OF TEMPERATURE

The components shall be subjected to test Nb of IEC Publication N° 60068-2-14. The number of cycles shall be 5 with 30 minutes at extreme temperature of the Technical Data Sheet.

9.27 PERMANENCE OF MARKING

In accordance with ESA/SCC Basic Specification N° 24800.

10. DATA DOCUMENTATION

10.1 GENERAL

For the qualification approval records and with each component delivery, a data documentation package is required. Depending on the lot acceptance level specified for the component, this package shall be compiled from:

- (a) Cover sheet (or sheets).
- (b) List of equipment (testing and measuring)
- (c) List of test references.
- (d) Final production test data (Chart II)(but see Para. 10.6)
- (e) Qualification test data (Chart IV)
- (f) Lot acceptance test data (Chart V)
- (g) Failed component list and failure analysis report (see Para. 8.4)
- (h) Certificate of Conformity.

Item (a) to (h) inclusive shall be grouped, preferably as subpackages and, for identification purposes, each page shall include the following information:

- Manufacturer's names.
- Lot identification.
- Date of establishment of the document.
- Page number.

10.1.1 Qualification approval

In the case of qualification approval, the items listed in Para. 10.1 (a) to (h) less item (f) are required.

	GENERIC SPECIFICATION		
	REF. : RAD-GEN-CONN-001		
	Date: September 21 st , 17	ED/REV: 2 -	PAGE: 32/ 33

10.1.2 Testing

For component deliveries, the items (d) and (h) of Para. 10.1 are required only.

For component deliveries with LAT2 and 1, item (a) to (h) less (e) are required.

10.2 COVER SHEET(S)

The cover sheet(s) of the data documentation package shall include as a minimum:

- (a) Reference to the Radiall Detail Specification including issue and date.
- (b) Reference to the applicable Radiall Generic Specification, including issue and date.
- (c) Component type and number.
- (d) Lot identification.
- (e) Number of purchase order.
- (f) Information relative to any additions to this specification and/or the Detail Specification.
- (g) Manufacturer's name and address.
- (h) Location of the manufacturing plant.
- (j) Signature on behalf of Manufacture.
- (k) Total number of pages of the data package.

10.3 LIST OF EQUIPMENT USED

List equipment used for tests and measurements shall be included in the data package, if not in accordance with the data given in the Product Quality Plan (PAQ). Where applicable, the list shall contain inventory number. Manufacturers type number, serial number etc... This list shall indicate for which tests equipment was used.

10.4 LIST OF TEST REFERENCES

This list shall include all Manufacturers' references or codes, which are necessary to correlate the test data provided with the applicable tests specified in the tables of the Detail Specification.

10.5 SPECIAL IN-PROCESS CONTROL DATA

Shall not be supplied.

10.6 FINAL PRODUCTION TEST DATA (Chart II)

A test result summary shall be compiled showing the total number of components submitted to, and the total number rejected after, each test, measurement and inspection of Chart II.

The final production test data shall form an integral part of the data documentation package, but it is not a mandatory requirement that it be delivered with the qualification lot or delivery lot. However, the data package to be delivered shall contain a list of final production tests actually performed and a certification that the data is available for review.

If not delivered, these data shall be retained by the Manufacturer for a minimum of 3 years during which time it shall be available to the Orderer, if requested, for review.

10.7 BURN-IN AND ELECTRICAL MEASUREMENT DATA (Chart III)

Not applicable.

10.8 QUALIFICATION TEST DATA (Chart IV)

All data shall be referenced to the relevant serial numbers. Detailed records shall be provided of the components submitted to each test in each of the subgroups and of those rejected.

Detailed data shall be provided of all electrical measurements made in accordance with Table 6 of the Detail Specification, as and where application.

	GENERIC SPECIFICATION		
	REF. : RAD-GEN-CONN-001		
	Date: September 21 st , 17	ED/REV: 2 -	PAGE: 33/ 33

10.9 LOT ACCEPTANCE TEST DATA (Chart V)

10.9.1 Testing

All data shall be referenced to the relevant serial numbers. Detailed records shall be provided of the components submitted to each test in each of the subgroups (as relevant to the lot acceptance level) and of those rejected.

Detailed data shall be provided of all electrical measurements made in accordance with Table 6 of the Detail Specification, as and where applicable.

10.10 FAILED COMPONENTS LIST AND FAILURE ANALYSIS REPORT

The failed component list and failure analysis report shall provide full details of :

- (a) The reference number and description of the test or measurement performed as defined in this specification and/or the Detail Specification.
- (b) The serial number (if application) of the failed component.
- (c) The failed parameter and the failure mode of the component.
- (d) Detailed failure analysis, if requested.

10.11 CERTIFICATE OF CONFORMITY

A certificate of Conformity shall be established as defined in Radiall procedure.

11. DELIVERY

For qualification approval, the disposition of the qualification test lot and its related documentation shall be as specified in the relevant paragraphs of Section 10 of this specification.

For procurement, for each order, the items forming the delivery are:

- (a) The delivery lot.
- (b) The components used for lot acceptance, but not forming part of the delivery lot (see Para. 8.2.4 and 8.2.5).
- (c) The relevant documentation in accordance with the requirements of Section 10 of this specification.

12. PACKAGING AND DESPATCH

The packaging and despatch of components to this specification shall be in accordance with the requirements of ESA/SCC Basic Specification N° 20600.