



Titre / Title

HIGH RELIABILITY

RF COAXIAL CONNECTORS

2.4mm TYPE, 50 OHMS

(MALE CONTACT)

Rédigé par / Written by	Responsabilité / Responsibility	Date	Signature
S. POIZAT	Space Project Manager	09/12/2015	
Vérifié par / Verified by			
V EUDELINÉ	Space B. U. Manager	09/12/2015	
Approuvée par / Approved by			
C. DAVENEL	Space Quality Manager	09/12/2015	

	DETAIL SPECIFICATION		
	REF. : RAD-DET-CONN-024		
	Date: December 9 th , 2015	ED/REV: 1 / -	PAGE : 2 / 17

DOCUMENTATION CHANGE NOTICE

REVISION OR ISSUE	DATE	CHANGE
1 -	09/12/2015	First issue



	DETAIL SPECIFICATION		
	REF. : RAD-DET-CONN-024		
	Date: December 9 th , 2015	ED/REV: 1 / -	PAGE : 3/ 17

TABLE OF CONTENTS

1. GENERAL	5
1.1 SCOPE	5
1.2 TYPE VARIANTS	5
1.3 MAXIMUM RATINGS	5
1.4 POWER DERATING INFORMATION (FIGURE 1)	5
1.5 PHYSICAL DIMENSIONS	5
1.6 STANDARD TEST CONNECTOR INTERFACE	5
2. APPLICABLE DOCUMENTS	10
3. TERMS, DEFINITIONS, ABBREVIATIONS, SYMBOLS AND UNITS	10
4. REQUIREMENTS	10
4.1 GENERAL	10
4.2 DEVIATIONS FROM GENERIC SPECIFICATION	10
4.2.1 <i>Deviations from Special In-Process Controls</i>	10
4.2.2 <i>Deviations from Final production Tests (Chart II)</i>	10
4.2.3 <i>Deviations from Qualification Tests (Chart IV)</i>	10
4.2.4 <i>Deviations from Lot Acceptance Tests (Chart V)</i>	10
4.3 MECHANICAL REQUIREMENTS	10
4.3.1 <i>Dimension Check</i>	10
4.3.2 <i>Weight</i>	11
4.3.3 <i>Coupling Proof Torque</i>	11
4.3.4 <i>Cable Retention Force</i>	11
4.3.5 <i>Mating and Unmating Forces</i>	11
4.3.6 <i>Endurance</i>	11
4.3.7 <i>Residual Magnetism</i>	11
4.3.8 <i>Contact Engagement and Separation Forces</i>	11
4.3.9 <i>Contact Retention</i>	12
4.4 MATERIALS AND FINISHES	12
4.4.1 <i>Standard Versions</i>	12
4.5 MARKING	13
4.5.1 <i>General</i>	13
4.5.2 <i>The RADIALL Component Number</i>	13
4.5.3 <i>Traceability Information</i>	13
4.5.4 <i>Marking of Small Components</i>	13
4.6 ELECTRICAL MEASUREMENTS	14
4.6.1 <i>Electrical Measurements at Room Temperature</i>	14
4.6.2 <i>Electrical Measurements at High and Low Temperatures (Table 3)</i>	14
4.6.3 <i>Circuits for Electrical Measurements</i>	14
4.7 BURN-IN TEST (TABLES 4 AND 5)	14
4.8 ENVIRONMENTAL AND ENDURANCE TESTS	14
4.8.1 <i>Measurements and Inspections on Completion of Environmental Tests</i>	14
4.8.2 <i>Measurements and Inspections at Intermediate Points during Endurance Tests</i>	14
4.8.3 <i>Measurements and Inspections on Completion of Endurance Tests</i>	14
4.8.4 <i>Conditions for Operating Life Tests (Part of Endurance Testing)</i>	14
4.8.5 <i>Electrical Circuits for Operating Life Tests</i>	14
4.8.6 <i>Conditions for High Temperature Storage Test (Part of Endurance Testing)</i>	14

	DETAIL SPECIFICATION		
	REF. : RAD-DET-CONN-024		
	Date: December 9 th , 2015	ED/REV: 1 / -	PAGE : 4/ 17

LIST OF TABLES

<u>Table 1 (a) – TYPE VARIANTS</u>	6
<u>Table 1 (b)- MAXIMUM RATINGS</u>	6
<u>Table 2 - ELECTRICAL MEASUREMENTS AT ROOM TEMPERATURE</u>	14
<u>Table 3 - ELECTRICAL MEASUREMENTS AT HIGH AND LOW TEMPERATURES</u> (Not applicable)	14
<u>Table 4 and 5 – BURN-IN TEST</u> (Not applicable)	14
<u>Table 6 - MEASUREMENTS AND INSPECTIONS ON COMPLETION OF ENVIRONMENTAL AND ENDURANCE TESTS</u>	15
<u>Table 7 - LIST OF PART NUMBERS WITH APPLICABLE POWER HANDLING CATEGORY</u>	17

LIST OF FIGURES

FIGURE 1 – POWER DERATING INFORMATION	7
Figure 1 (a) – Power Versus Frequency	7
Figure 1 (b) – Power Versus Temperature	7
FIGURE 2 – PHYSICAL DIMENSIONS	8
Figure 2 (a) – Connector Interface – Male contact	8
FIGURE 3 – STANDARD TEST CONNECTOR INTERFACE	9
Figure 3 (a) – Standard Test Connector Interface – Female contact	9
FIGURE 4 – TEST PIN CONFIGURATION	12

	DETAIL SPECIFICATION		
	REF. : RAD-DET-CONN-024		
	Date: December 9 th , 2015	ED/REV: 1 / -	PAGE : 5 / 17

1. GENERAL

1.1 SCOPE

This specification details the ratings, physical and electrical characteristics, test and inspection data for RF Coaxial connectors, Type 2.4mm, 50 Ohms (Male contact). It shall be read in conjunction with RADIALL Generic Specification RAD-GEN-CONN-001, the requirements of which are supplemented herein.

1.2 TYPE VARIANTS

For each type variant, the full electrical and physical characteristics are given in individual technical data sheet.

1.3 MAXIMUM RATINGS

The maximum ratings, which shall not be exceeded at any time during use or storage, applicable to the connectors specified herein, are as scheduled in Table 1(b).

1.4 POWER DERATING INFORMATION (FIGURE 1)

The power derating information applicable to the connectors specified herein is shown in Figure 1.

1.5 PHYSICAL DIMENSIONS

The physical dimensions of the connectors specified herein are shown in Figure 2(a) and technical data sheet.

1.6 STANDARD TEST CONNECTOR INTERFACE

Whenever gauges are required for mating with the connectors under test, their physical dimensions shall be in accordance with those specified in Figure 3.

	DETAIL SPECIFICATION		
	REF. : RAD-DET-CONN-024		
	Date: December 9 th , 2015	ED/REV: 1 / -	PAGE : 6 / 17

Table 1 (a) – TYPE VARIANTS

(See RADIALL technical data sheets)

Table 1 (b)- MAXIMUM RATINGS

N°	CHARACTERISTICS	SYMBOL	MAXIMUM RATINGS	UNIT	REMARKS
1	Power	P	See figures 1 (a) and 1 (b)	W	For information
2	Nominal impedance	Z	50	Ω	-
3	Frequency Range	f	See technical data sheet	GHz	-
4	Dielectric Withstanding Voltage at ambient pressure	V _{dw}	See technical data sheet	V _{rms}	At sea level
5	Dielectric Withstanding Voltage at low pressure	V _{lp}	10% of V _{dw}	V _{rms}	At 44 mb
6	Rated Operating Voltage	V _{op}	See technical data sheet	V _{rms}	
7	Corona Level	V _{co}	8,5% of V _{dw}	V _{rms}	-
8	Operating Temperature Range	T _{op}	See technical data sheet	°C	-
9	Storage Temperature Range	T _{stg}	As per Operating Temperature Range	°C	-

	DETAIL SPECIFICATION		
	REF. : RAD-DET-CONN-024		
	Date: December 9 th , 2015	ED/REV: 1 / -	PAGE : 7 / 17

FIGURE 1- POWER DERATING INFORMATION

FIGURE 1(a) POWER VERSUS FREQUENCY

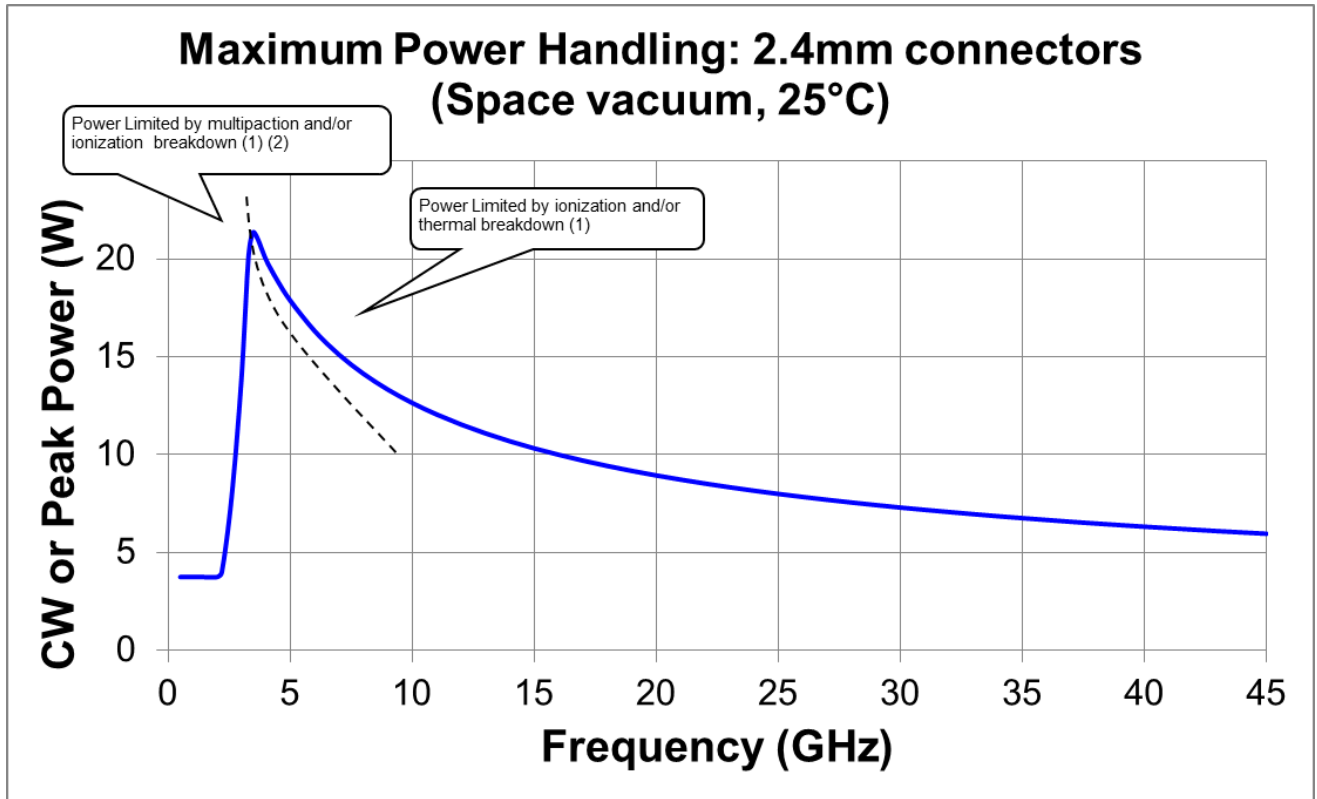

- Notes:**
 1: Load VSWR is better than 1,30:1
 2: The part of the curve limited by multipaction takes into account a 6 dB margin as recommended by ESA

FIGURE 1(b) POWER VERSUS TEMPERATURE

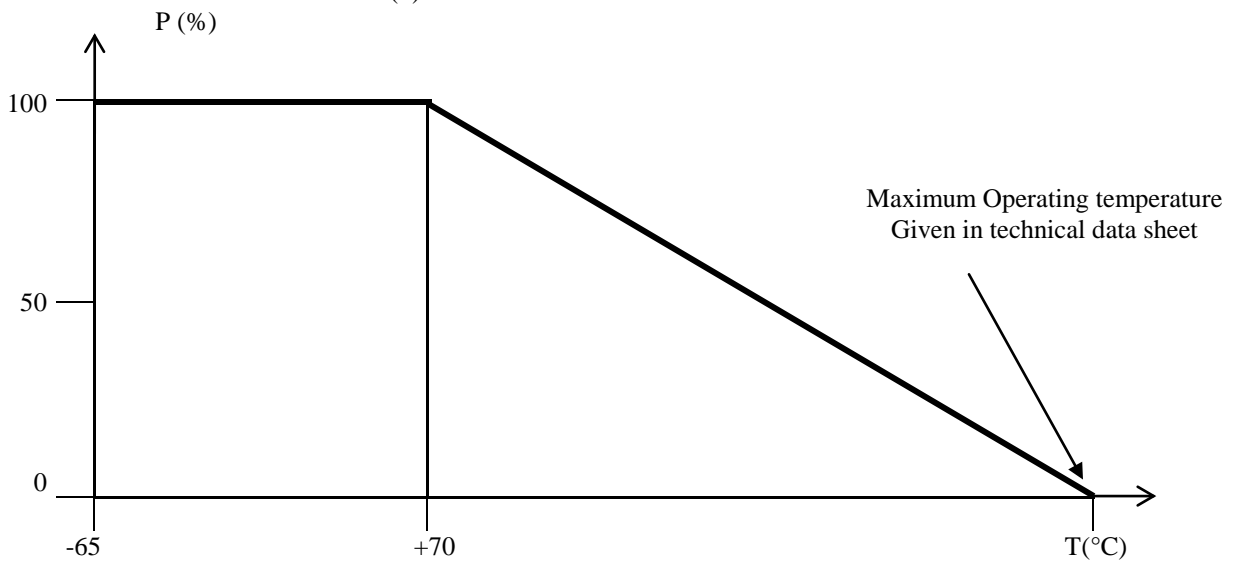
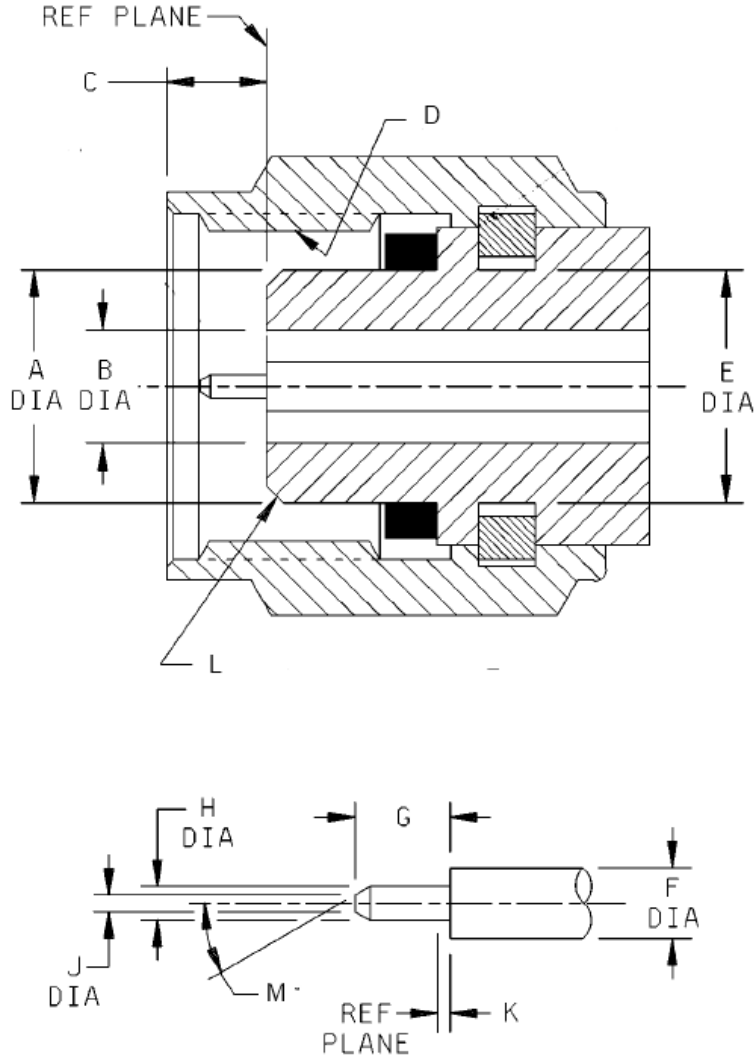

FIGURE 2 PHYSICAL DIMENSIONS

FIGURE 2(a) – CONNECTOR INTERFACE MALE CONTACT



Symbols	Dimension (mm)		Comment
	Min	Max	
ØA	4.725	4.75	
ØB	2.387	2.413	
C	1.85	2.45	
D	M7 x .075-6g		
ØE	4.75	4.85	
ØF	1.029	1.054	
G	1.34	1.45	
ØH	0.506	0.523	
ØJ	0.2	0.25	
K	0	0.08	
L	0.25 x 45°±2	0.35 x 45°±2	Chamfer
M	28	32	°

FIGURE 3 – STANDARD TEST CONNECTOR INTERFACE

FIGURE 3 (a) – STANDARD TEST CONNECTOR INTERFACE, FEMALE CONTACT

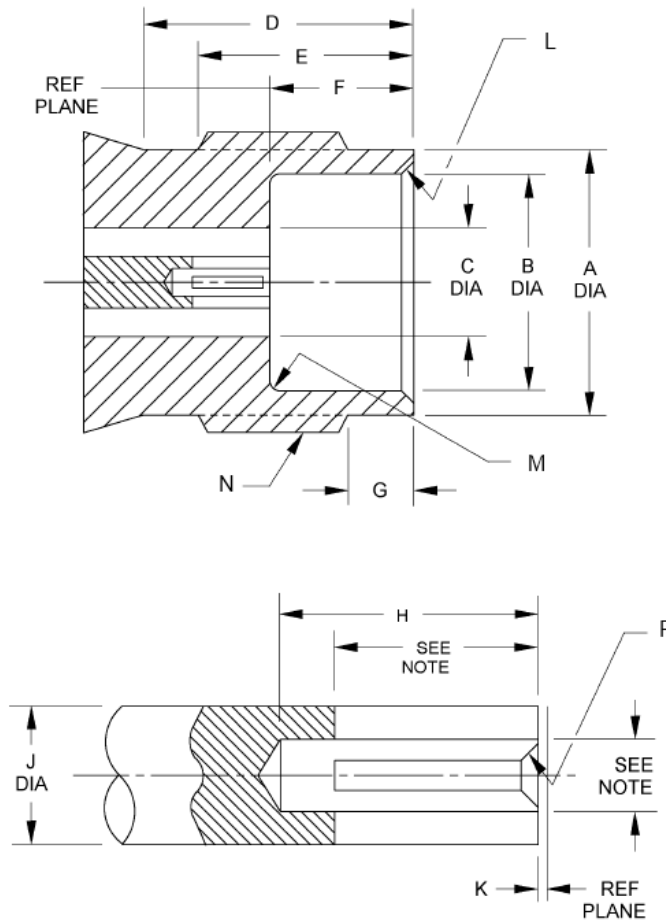

Symbols	Dimension (mm)		Comment
	Min	Max	
ØA	5.79	5.89	
ØB	4.77	4.8	
ØC	2.387	2.413	
D	6	-	
E	4.8	5.06	
F	3	3.1	
G	1.37	1.63	
H	2.65	-	
ØJ	1.029	1.054	
K	0	0.08	
L	0.1 x 45°±2	0.2 x 45°±2	Chamfer
M	-	0.127	Radius
N	M7 x .075-6g		
P	0.1 x 30°±2	0.15 x 30°±2	Chamfer

Note: Shall meet the electrical and mechanical performance requirements when mated with a 2.4mm pin as specified in this specification

	DETAIL SPECIFICATION		
	REF. : RAD-DET-CONN-024		
	Date: December 9 th , 2015	ED/REV: 1 / -	PAGE : 10/ 17

2. APPLICABLE DOCUMENTS

The following documents form part of this specification and shall be read in conjunction with it :

- (a) RADIALL Generic Specification RAD-GEN-CONN-001 for RF Coaxial Connectors.
- (b) MIL G.45204 Gold plating Electrodeposited.
- (c) MIL PRF. 39012 Connectors Coaxial RF General Specification for.

3. TERMS, DEFINITIONS, ABBREVIATIONS, SYMBOLS AND UNITS

For the purpose of this specification, the terms, definitions, abbreviations, symbols and units specified in ESA/SCC Basic specification N° 21300 shall apply.

In addition the following shall apply:

- V_{dw} Dielectric Withstanding Voltage at ambient pressure (sea level)
- V_{lp} Dielectric Withstanding Voltage at low pressure (44 mb)
- V_{co} Corona Level Voltage
- R_i Insulation Resistance
- I_L Leakage Current

4. REQUIREMENTS

4.1 GENERAL

The complete requirements for procurement of the connectors specified herein are stated in this specification and RADIALL Generic Specification RAD-GEN-CONN-001 Deviations from the Generic Specification applicable to this specification only, are listed in Para.4.2.

Deviations from the applicable Generic Specification and this Detail Specification do not affect the components' reliability, are listed in the appendices attached to this specification.

4.2 DEVIATIONS FROM GENERIC SPECIFICATION

4.2.1 Deviations from Special In-Process Controls

None.

4.2.2 Deviations from Final production Tests (Chart II)

None.

4.2.3 Deviations from Qualification Tests (Chart IV)

None.

4.2.4 Deviations from Lot Acceptance Tests (Chart V)

None.

4.3 MECHANICAL REQUIREMENTS

4.3.1 Dimension Check

The dimensions of the connectors specified herein shall be verified in accordance with the requirements set out in Para.9.25 of RADIALL Generic Specification RAD-GEN-CONN-001 and shall conform to those shown in Figures 2(a) and in technical data sheet.

	DETAIL SPECIFICATION	
	REF. : RAD-DET-CONN-024	
	Date: December 9 th , 2015	ED/REV: 1 / -

4.3.2 Weight

The maximum weight of the connectors specified herein shall be as specified in technical data sheet.

4.3.3 Coupling Proof Torque

The requirements for testing of the coupling proof torque are specified in Section 9 of RADIALL Generic Specification RAD-GEN-CONN-001. The applied torque shall be 170N.cm.

4.3.4 Cable Retention Force

The requirements for testing of the cable retention force are specified in Section 9 of RADIALL Generic Specification RAD-GEN-CONN-001. The technical data sheet specifies the values for axial loads. Torque shall be applied as follows :

4.3.4.1 Flexible Cables

Flexible cables shall be rotated 180° in both directions.

Rotational movement shall be applied at 15 cm from the connector.

4.3.4.2 Semi-rigid Cables

The torque value shall be as follows:

RG 405/U: 11.28N.cm.	2.20mm (.085 ") semi-rigid cable
RG 402/U: 38.85N.cm.	3.58mm (.141 ") semi-rigid cable

4.3.5 Mating and Unmating Forces

The applicable measurement requirements are specified in Section 9 of RADIALL Generic Specification RAD-GEN-CONN-001. The maximum torque during mating and unmating shall not exceed 24N.cm.

Whenever a test is performed on mated pairs of connectors, the pairs shall be torqued at 80-115N.cm.

4.3.6 Endurance

The applicable test requirements are specified in Section 9 of RADIALL Generic Specification RAD-GEN-CONN-001. The test conditions shall be as follows :

- (a) Number of cycles : 500 for qualification ; 100 for lot acceptance
- (b) Rate : 12 cycles maximum/minute.

4.3.7 Residual Magnetism

Not applicable.

Residual magnetism is not applicable to stainless steel versions, and Beryllium copper Nickel underplate version.

4.3.8 Contact Engagement and Separation Forces

The requirements for these measurements are specified in Section 9 of RADIALL Generic Specification RAD-GEN-CONN-001 and apply to female contacts only.

(a) Oversize Pin

Steel test pin diameter	: 0.546/0.551mm.
Insertion depth	: 1.3/1.4 mm.
Number of insertions	: 3.

(b) Engagement Force Test

Steel test pin diameter : 0.533/0.538 mm.
Engagement depth : 1.3/1.4 mm.
Engagement force : 1131g max.

(c) Separation Force Test

Steel test pin diameter : 0.477/0.482 mm.
Separation depth : 1.3/1.4 mm.
Separation force : 20.3g min.

FIGURE 4 – TEST PIN CONFIGURATION

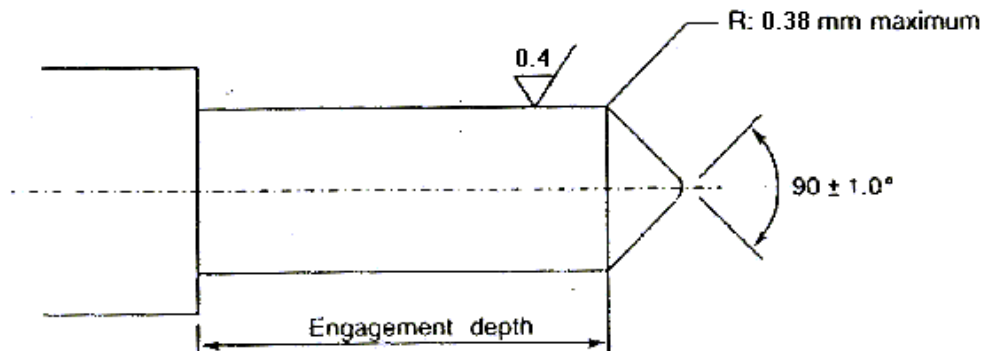

4.3.9 Contact Retention

The requirements for this test are specified in Section 9 of RADIALL Generic Specification RAD-GEN-CONN-001. The test conditions are given in technical data sheet. After testing, the connector interface dimensions shall be within the limits of Figure 2(a).

4.4 MATERIALS AND FINISHES

The material and finishes shall be as specified herein. Where a definite material is not specified, a material which will enable the connectors specified herein to meet the performance requirements of this specification shall be used. Acceptance or approval of any constituent material does not guarantee acceptance of the finished product.

4.4.1 Standard Versions

(a) Shell, Coupling Nut

Material : Amagnetic stainless steel passivated
Beryllium Copper or Brass with Gold 1.3µm over Nickel 2µm

(b) Centre Contact

Material : Beryllium copper
Underplate : Nickel, 2.0 µm minimum
Plating : Gold, 1.27 µm minimum, Type II of MIL-G-45204

(c) Inserts

Material : PEEK 150G

	DETAIL SPECIFICATION		
	REF. : RAD-DET-CONN-024		
	Date: December 9 th , 2015	ED/REV: 1 / -	PAGE : 13 / 17

4.5 MARKING

4.5.1 General

The marking of all delivered to this specification shall be in accordance with the following paragraphs. Each component shall be marked in respect of:

- (a) The RADIALL Component Number
- (b) Traceability Information

4.5.2 The RADIALL Component Number

The RADIALL Component Number shall be constituted and marked as follows :

R327556600 (Example of RADIALL Reference Number)

4.5.3 Traceability Information

Each component shall be marked in respect of traceability information in accordance with the requirements of ESA/SCC Basic Specification N° 21700.

4.5.4 Marking of Small Components

When it is considered that the component is too small to accommodate the marking as specified above, as much as space permits shall be marked. The order of precedence shall be as follows :

- Traceability information
- RADIALL component number

The marking information in full shall accompany each component in its primary package.

	DETAIL SPECIFICATION		
	REF. : RAD-DET-CONN-024		
	Date: December 9 th , 2015	ED/REV: 1 / -	PAGE : 14 / 17

4.6 ELECTRICAL MEASUREMENTS

4.6.1 Electrical Measurements at Room Temperature

The parameters to be measured in respect of electrical characteristics are scheduled in Table 2. Unless otherwise specified, the measurements shall be performed at $T_{amb} = +22 \pm 3^{\circ}C$.

4.6.2 Electrical Measurements at High and Low Temperatures (Table 3)

Not applicable.

4.6.3 Circuits for Electrical Measurements

Not applicable.

4.7 BURN-IN TEST (TABLES 4 AND 5)

Not applicable.

Table 2 - ELECTRICAL MEASUREMENTS AT ROOM TEMPERATURE

N°	CHARACTERISTICS	SYMBOL	SPEC.AND/OR TEST METHOD	TEST CONDITIONS	LIMITS		UNIT
					MIN	MAX	
1	Insulation Resistance	R _i	RADIALL RAD-GEN-CONN-001 Para. 9.1	500 Vdc	5000	-	MΩ
2	Dielectric Withstanding Voltage Leakage Current	I ₁	RADIALL RAD-GEN-CONN-001 Para. 9.2	Per Dielectric Withstanding Voltage in Technical Data Sheet	-	2.0	mA

Table 3 - ELECTRICAL MEASUREMENTS AT HIGH AND LOW TEMPERATURES (Not applicable)

Not applicable.

Table 4 and 5 – BURN-IN TEST (Not applicable)

Not applicable.

4.8 ENVIRONMENTAL AND ENDURANCE TESTS

4.8.1 Measurements and Inspections on Completion of Environmental Tests

The parameters to be measured on completion of environmental tests are scheduled in Table 6 of this specification. Unless otherwise stated, the measurements shall be performed at $T_{amb} = +22 \pm 3^{\circ}C$.

4.8.2 Measurements and Inspections at Intermediate Points during Endurance Tests

Not applicable.

4.8.3 Measurements and Inspections on Completion of Endurance Tests

The parameters to be measured on completion of endurance tests are scheduled in Table 6 of this specification. Unless otherwise stated, the measurements shall be performed at $T_{amb} = +22 \pm 3^{\circ}C$.

4.8.4 Conditions for Operating Life Tests (Part of Endurance Testing)

Not applicable.

4.8.5 Electrical Circuits for Operating Life Tests

Not applicable.

4.8.6 Conditions for High Temperature Storage Test (Part of Endurance Testing)

The requirements for the high temperature storage test are specified in Section 9 of RADIALL Generic Specification RAD-GEN-CONN-001. The conditions for high temperature storage shall be maximum operating temperature as specified in technical data sheet.

Table 6 - MEASUREMENTS AND INSPECTIONS ON COMPLETION OF ENVIRONMENTAL AND ENDURANCE TESTS

No	RADIALL GENERIC SPÉCIFICATION RAD -GEN-CONN- 001		MEASUREMENTS AND INSPECTION			LIMITS		UNIT	
	ENVIRONMENTAL & ENDURANCE TEST (1)	TEST METHOD AND CONDITIONS	IDENTIFICATION	CONDITIONS	SYMBOL	MIN.	MAX.		
01	Contact resistance	Para. 9.9	Contact resistance	Centre Contact Shell Hermetic Centre Contact		- - -	3.0 2.0 10	mΩ mΩ mΩ	
02	Vibration	Para 9.10	Full Engagement Contact Resistance Visual Examination	Centre Contact		-	3.0	mΩ	
03	Shock or Bump	Para 9.11	Full Engagement Contact Resistance Visual Examination	Centre Contact		-	3.0	mΩ	
04	Rapid Change of Temperature	Para 9.12	Contact Resistance	Centre Contact		-	3.0	mΩ	
			Dielect. Withstanding Volt. Leakage Current Visual Examination	Technical Data Sheet	I ₁	-	2.0	mA	
05	Climatic sequence	Para 9.13	Dielect. Withstanding Volt. At Low Pressure (44 mb) Insulation Resistance	Table 1 (b) After Damp Heat (Within 1 to 24 Hrs recovery) : Table 2 Item 1 Technical Data Sheet	No breakdown or flashover	R _i	5000	-	MΩ
			Dielect. Withstanding Volt. Leakage Current External Visual Inspection	Technical Data Sheet RAD-GEN-CONN-001 para. 9.8					
06	Cable Retention Force	Para's 9.14 and 4.3.4 of this spec.	Continuity						
07	Coupling Proof Torque	Para 9.4	Interface Dimensions Visual Examination				Figure 2(a)		
08	Marking / Unmating Forces	Para 9.5	Torque	Para. 4.3.5		-	24	N.cm	
09	Seal Test	Para 9.7	Hermeticity Leakage External Visual Inspection	If applicable As Applicable RAD-GEN-CONN-001 para. 9.8		-	1*10 ⁻⁸ No Bubble	Cm ³ /s	
10	Cabling and Crimping Capability	Para 9.15	Visual Examination	RAD-GEN-CONN-001 para. 9.15	Fig.2(a) & technical data sheet	R _i	5000	-	MΩ
			Dimension	RAD-GEN-CONN-001 para. 9.15					
			Insulation Resistance	Table 2 Item 1					
			Dielect. Withstanding Volt. Leakage Current	Technical Data sheet					
11	VSWR or Reflection Coefficient	Para 9.16	VSWR	RAD-GEN-CONN-001 Para. 9.16			Technical Data Sheet		
12	Corona Level	Para 9.17	Corona	RAD-GEN-CONN-001 Para. 9.17			Table 1 (b)		

Notes:

- The tests in this table refer to either Chart IV or V and shall be used as applicable.

TABLE 6 – MEASUREMENTS AND INSPECTIONS ON COMPLETION OF ENVIRONMENTAL AND ENDURANCE TESTS

No	RADIALL GENERIC SPÉCIFICATION RAD -GEN-CONN- 001		MEASUREMENTS AND INSPECTION			LIMITS		UNIT
	ENVIRONMENTAL & ENDURANCE TEST (1)	TEST METHOD AND CONDITIONS	IDENTIFICATION	CONDITIONS	SYMBOL	MIN.	MAX.	
13	Endurance	Para's 9.18 and 4.3.6 of this spec	Mating /Unmating forces Contact resistance Visual examination	Para. 4.3.5 Centre contact Shell Hermetic centre Contact		- - - -	24 4.0 3.0 12	N.cm mΩ mΩ mΩ
14	RF Insertion-Loss	Para.9.19	Insertion Loss	RAD-GEN-CONN-001 Para.9.19		Technical Data Sheet		
15	Corrosion	Para.9.20	Visual examination		No Exposure of Base Metal			
16	Residual Magnetism	Para.9.21	Magnetism					
17	Soldering Proof	Para.9.22	Interface Dimensions Mating / Unmating Forces Insulation resistance Dielect. Withstanding Volt. Leakage Current Contact Resistance External Visual Inspection	Para.4.3.5 Table 2 Item 1 Technical Data sheet Centre contact Shell Hermetic centre Contact	Ri I _l	- 5000 - - -	2 - 2.0 3.0 2.0 10	N.cm MΩ mA mΩ mΩ mΩ
18	RF Leakage	Para.9.23	Leakage			Figure 2(b)		
19	High Temperature Storage	Para.9.23 and 4.8.6 of this spec.	Mating / Unmating Forces Insulation resistance Dielect. Withstanding Volt. Leakage Current Contact retention Visual Examination Contact Resistance External Visual Inspection	Para.4.3.5 Table 2 Item 1 Technical Data sheet Para 4.3.9 - Centre contact Shell Hermetic centre Contact RAD-GEN-CONN-001 Para.9.8	Ri I _l	- 5000 - - - - - -	24 - 2.0 Para. 4.3.9 - 8.0 7.5 15 -	N.cm MΩ mA mΩ mΩ mΩ
20	External Visual Inspection	Para.9.8				-	-	
21	Permanence of Marking	Para.9.27				-	-	

Notes:

- The tests in this table refer to either Chart IV or V and shall be used as applicable.

	DETAIL SPECIFICATION	
	REF. : RAD-DET-CONN-024	
	Date: December 9 th , 2015	ED/REV: 1 / -

Table 7 - LIST OF PART NUMBERS WITH APPLICABLE POWER HANDLING CATEGORY

See the detail specification RAD-LIS-CONN-001.