



LOAD, RF, COAXIAL, TYPE SMA 2.9, DC - 31.5GHz

ESCC Detail Specification No. 3403/009

Issue 6	July 2018
---------	-----------



LEGAL DISCLAIMER AND COPYRIGHT

European Space Agency, Copyright © 2018. All rights reserved.

The European Space Agency disclaims any liability or responsibility, to any person or entity, with respect to any loss or damage caused, or alleged to be caused, directly or indirectly by the use and application of this ESCC publication.

This publication, without the prior permission of the European Space Agency and provided that it is not used for a commercial purpose, may be:

- copied in whole, in any medium, without alteration or modification.
- copied in part, in any medium, provided that the ESCC document identification, comprising the ESCC symbol, document number and document issue, is removed.

DOCUMENTATION CHANGE NOTICE

(Refer to <https://escies.org> for ESCC DCR content)

DCR No.	CHANGE DESCRIPTION
1164	Specification upissued to incorporate changes per DCR.

TABLE OF CONTENTS

1	GENERAL	5
1.1	SCOPE	5
1.2	APPLICABLE DOCUMENTS	5
1.3	TERMS, DEFINITIONS, ABBREVIATIONS, SYMBOLS AND UNITS	5
1.4	THE ESCC COMPONENT NUMBER AND COMPONENT TYPE VARIANTS	5
1.4.1	THE ESCC COMPONENT NUMBER	5
1.4.2	COMPONENT TYPE VARIANTS AND RANGE OF COMPONENTS	5
1.5	MAXIMUM RATINGS	6
1.6	PHYSICAL DIMENSIONS	7
1.6.1	INTERFACE DIMENSIONS	9
1.6.2	MATING GAUGE DIMENSIONS	11
1.7	MATERIALS AND FINISHES	14
2	REQUIREMENTS	14
2.1	GENERAL	14
2.1.1	DEVIATIONS FROM THE GENERIC SPECIFICATION	14
2.1.1.1	DEVIATIONS FROM QUALIFICATION AND PERIODIC TESTS - CHART F4	14
2.2	MARKING	14
2.3	CONTACT ENGAGEMENT AND SEPARATION FORCES TEST	15
2.4	COUPLING PROOF TORQUE TEST	15
2.5	MATING AND UNMATING FORCES TEST	15
2.6	ELECTRICAL MEASUREMENTS AT ROOM, HIGH AND LOW TEMPERATURES	15
2.6.1	ROOM TEMPERATURE ELECTRICAL MEASUREMENTS	16
2.6.2	HIGH AND LOW TEMPERATURES ELECTRICAL MEASUREMENTS	16
2.7	PARAMETER DRIFT VALUES	16
2.8	INTERMEDIATE AND END-POINT ELECTRICAL MEASUREMENTS	17
2.9	BURN-IN CONDITIONS	19
2.10	OPERATING LIFE CONDITIONS	19

1 GENERAL

1.1 SCOPE

This specification details the ratings, physical and electrical characteristics and test and inspection data for the component type variants and/or the range of components specified below. It supplements the requirements of, and shall be read in conjunction with, the ESCC Generic Specification listed under Applicable Documents.

1.2 APPLICABLE DOCUMENTS

The following documents form part of this specification and shall be read in conjunction with it:

- (a) ESCC Generic Specification No. [3403](#).

1.3 TERMS, DEFINITIONS, ABBREVIATIONS, SYMBOLS AND UNITS

For the purpose of this specification, the terms, definitions, abbreviations, symbols and units specified in ESCC Basic Specification No. [21300](#) shall apply.

1.4 THE ESCC COMPONENT NUMBER AND COMPONENT TYPE VARIANTS

1.4.1 The ESCC Component Number

The ESCC Component Number shall be constituted as follows:

Example: 340300903

- Detail Specification Reference: 3403009
- Component Type Variant Number: 03 (as required)

1.4.2 Component Type Variants and Range of Components

The component type variants and range of components applicable to this specification are as follows:

Variant Number	Description	Voltage Standing Wave Ratio		Weight Max (g)
		DC to 20GHz	20 to 31.5GHz	
03	Male Load	≤ 1.2	≤ 1.25	5
04	Female Load	≤ 1.2	≤ 1.25	5

1.5 MAXIMUM RATINGS

The maximum ratings shall not be exceeded at any time during use or storage.

Maximum ratings shall only be exceeded during testing to the extent specified in this specification and when stipulated in Test Methods and Procedures of the ESCC Generic Specification.

Characteristics	Symbols	Maximum Ratings	Units	Remarks
RF Power	P_{RF}	1	W	$T_{amb} \leq +70^{\circ}C$ Note 1
Peak Power	P_P	50	W	duration 1 μ s 1% duty cycle
DC Power	P_{DC}	1	W	$T_{amb} \leq +70^{\circ}C$
Impedance	Z	47.5 to 52.5	Ω	-
Frequency Range	f_{op}	DC to 40	GHz	-
RF Leakage	E	-85	dBi	-
Operating Temperature Range	T_{op}	-55 to +125	$^{\circ}C$	T_{amb}
Storage Temperature Range	T_{stg}	-55 to +125	$^{\circ}C$	-
Coupling Nut Torque Range	T_q	80 to 115	N.cm	Note 2

NOTES:

1. RF Power shall be derated against operating temperature as follows: For $T_{amb} > +70^{\circ}C$, derate linearly to 25% of RF Power at $+125^{\circ}C$.
2. Coupling Proof Torque: 170N.cm. During engagement of the component with its mating counterpart the body of the component shall be restrained by means of the body flats whilst torque is applied to the coupling nuts (see Physical Dimensions).

1.6 PHYSICAL DIMENSIONS

MALE LOAD

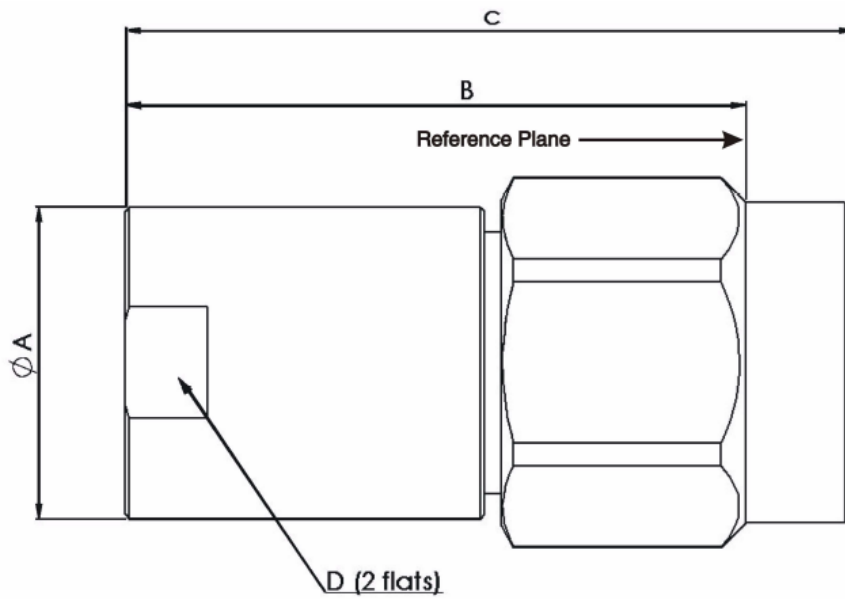

Symbols	Dimensions mm	
	Min	Max
$\varnothing A$	7	8
B	14.5	15.5
C	-	18.5
D	6.5	7.5

FEMALE LOAD

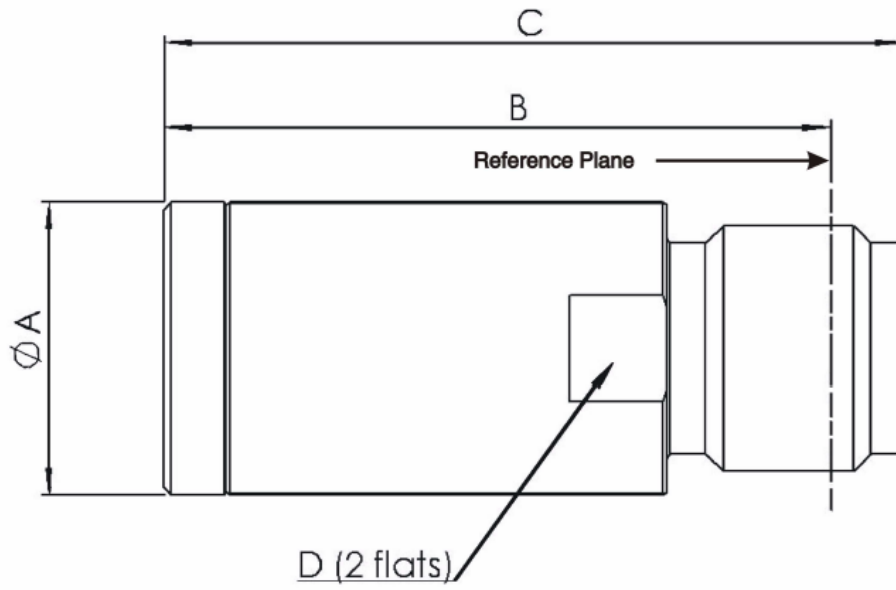

Symbols	Dimensions mm	
	Min	Max
$\varnothing A$	7	8
B	16.5	17.5
C	-	19.5
D	6.5	7.5

1.6.1 Interface Dimensions

Female Interface

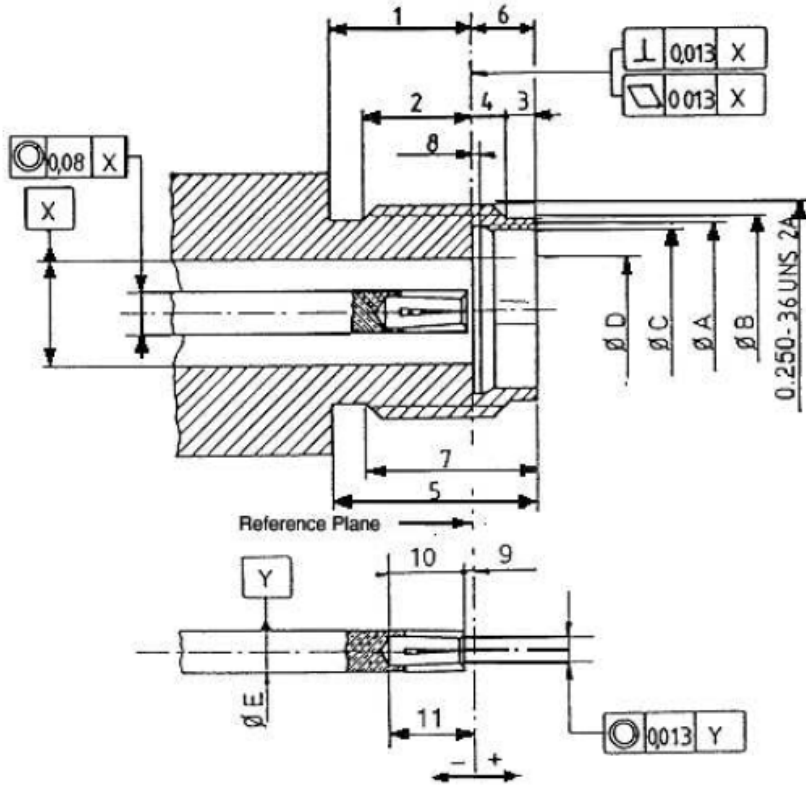

Symbols	Dimensions mm	
	Min	Max
1	3.82	4.32
2	2.87	3.27
3	0.65	0.95
4	0.93	1.33
5	5.8	6.2
6	1.88	1.98
7	4.85	5.15
8	0.3	0.5
9	0	0.08
10	2.8	3.2
11	2.8	3.28
ØA	4.8	5
ØB	5.3	5.35
ØC	4.6	4.63
ØD	2.905	2.945
ØE	1.26	1.28

Male Interface

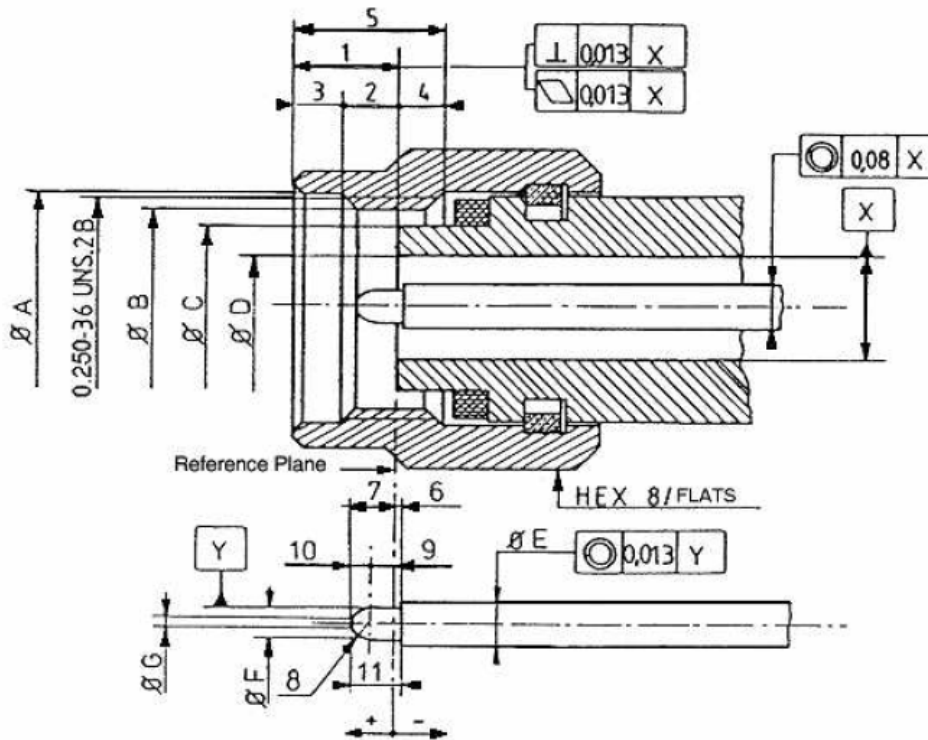

Symbols	Dimensions mm		Notes
	Min	Max	
1	2.63	3.25	
2	1.58	2.2	
3	0.75	1.15	
4	0.85	1.47	
5	3.8	4.2	
6	0	0.08	
7	1.42	1.6	
8	0.8	0.9	Radius
9	0.693	0.984	
10	0.616	0.727	
11	1.5	1.6	
ØA	6.6	6.7	
ØB	5.59	-	
ØC	4.55	4.58	
ØD	2.905	2.94	
ØE	1.26	1.28	
ØF	0.92	0.94	
ØG	0.2	0.34	

1.6.2 Mating Gauge Dimensions

Female Interface

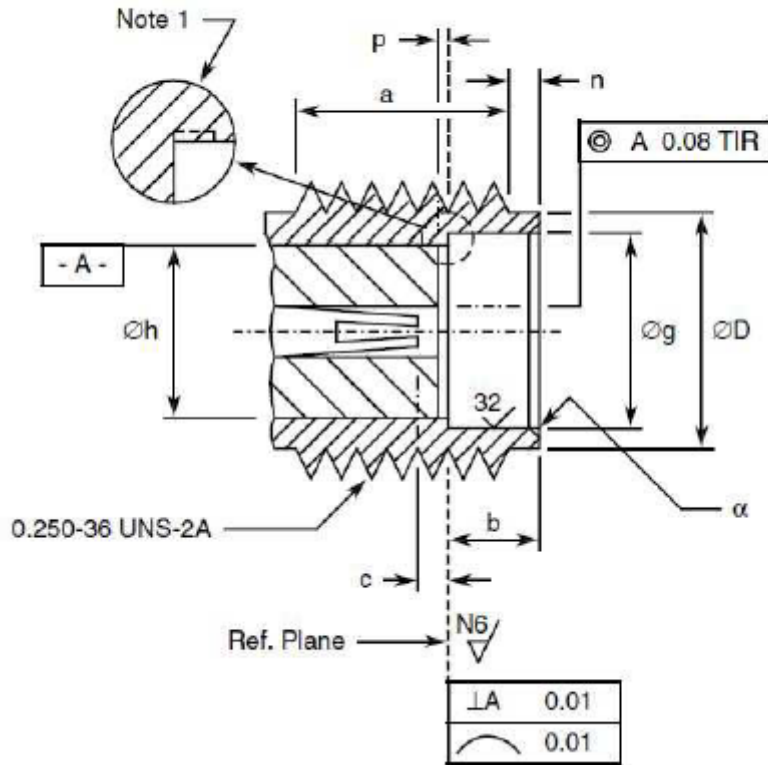

Detailed view of centre contact

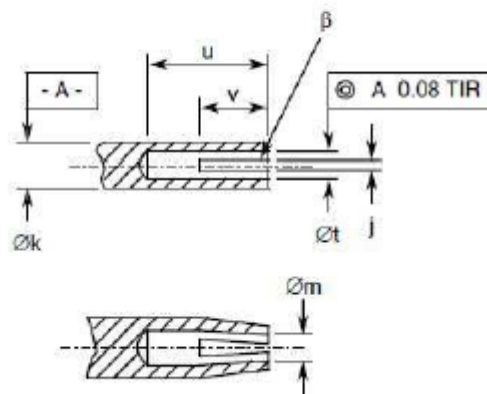

Symbols	Dimensions mm		Notes
	Min	Max	
a	3.81	-	
b	1.88	1.98	
c	0	0.08	Contact recess
ØD	5.28	5.49	
Øg	4.6	4.67	
Øh	4.1	4.13	
j	0.13	0.23	2 or more slots
Øk	1.27	1.29	
Øm	0.72	0.84	After closing
n	0.38	1.14	
p	0	0.05	Insert recess
u	2.54	-	
Øt	0.94	0.99	
v	1.91	2.41	
α	-	0.25	45° Chamfer
β	0.99	1.19	45° Chamfer

NOTES:

1. No fillet permitted. Radial undercut 0.2mm maximum deep x 0.89mm maximum long permitted.

Male Interface

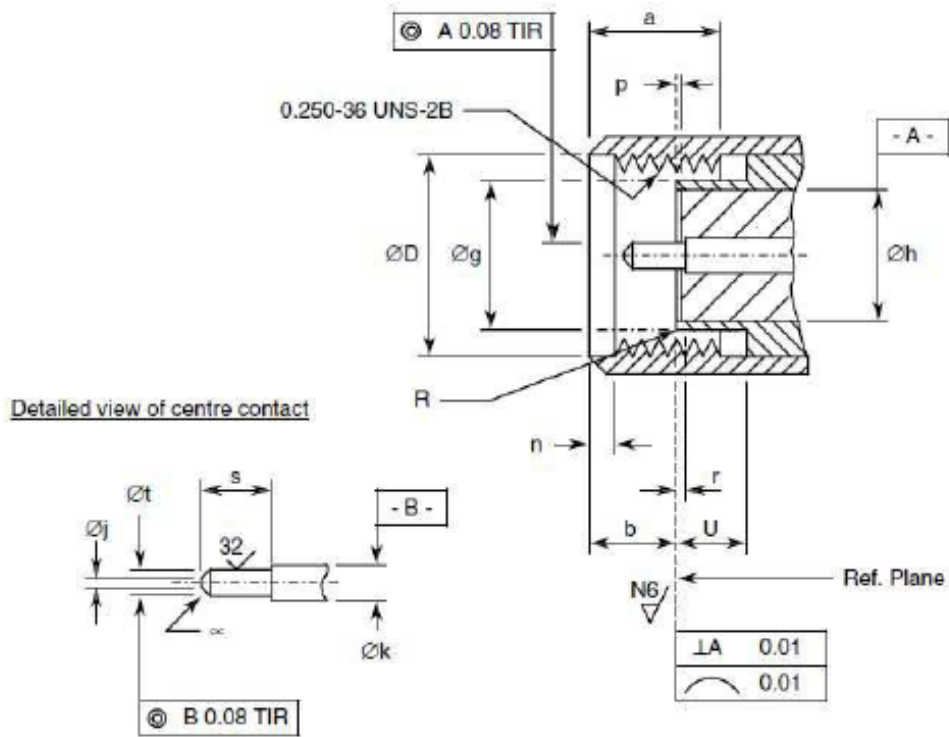

Symbols	Dimensions mm		Notes
	Min	Max	
a	3.71	4.32	
b	2.59	3.35	
ØD	6.48	6.73	
Øg	4.34	4.59	
Øh	4.1	4.13	
Øj	-	0.38	Flat
Øk	1.27	1.29	
n	0.64	1.14	
p	0	0.05	Insert recess
r	0	0.08	Contact recessed
R	-	0.08	Radius
s	2.03	2.29	
Øt	0.9	0.93	
U	2.03	-	
α	-	-	45 ±3° Chamfer

1.7 MATERIALS AND FINISHES

Materials and finishes shall be as follows:

- Shell, Coupling Nut: Amagnetic Stainless Steel, electro-passivated
- Centre Contact: Beryllium Copper, with nickel underplate (2µm minimum) and Gold plating (1.3µm minimum). Measurements of plating thickness shall be performed inside the female centre contact at a maximum distance of 0.4mm from the end and on the male centre contact on pin diameter $\varnothing F$ (see Interface Dimensions).
- Inserts: ULTEM 1000
- Gaskets: Silicone rubber.

2 REQUIREMENTS

2.1 GENERAL

The complete requirements for procurement of the components specified herein are as stated in this specification and the ESCC Generic Specification. Permitted deviations from the Generic Specification, applicable to this specification only, are listed below.

Permitted deviations from the Generic Specification and this Detail Specification, formally agreed with specific Manufacturers on the basis that the alternative requirements are equivalent to the ESCC requirement and do not affect the component's reliability, are listed in the appendices attached to this specification.

2.1.1 Deviations from the Generic Specification

2.1.1.1 *Deviations from Qualification and Periodic Tests - Chart F4*

- (a) Residual Magnetism: is not applicable.

2.2 MARKING

The marking shall be in accordance with the requirements of ESCC Basic Specification No. [21700](#) and as follows.

The information to be marked on the component shall be:

- (a) The ESCC qualified components symbol (for ESCC qualified components only).
- (b) The ESCC Component Number.
- (c) Traceability information.

2.3 CONTACT ENGAGEMENT AND SEPARATION FORCES TEST

Ref. Contact Engagement and Separation Forces in the ESCC Generic Specification.

- (a) Oversize Test Pin
 - Pin diameter: 0.95/0.955mm
 - Insertion depth : 0.76/1.14mm
- (b) Maximum Diameter Test Pin
 - Pin diameter: 0.94/0.946mm
 - Engagement depth: 1.27/1.9mm
 - Engagement force: 1380g maximum.
- (c) Minimum Diameter Test Pin
 - Pin diameter: 0.89/0.902mm
 - Separation depth: 1.27/1.9mm
 - Separation force: 28g minimum.

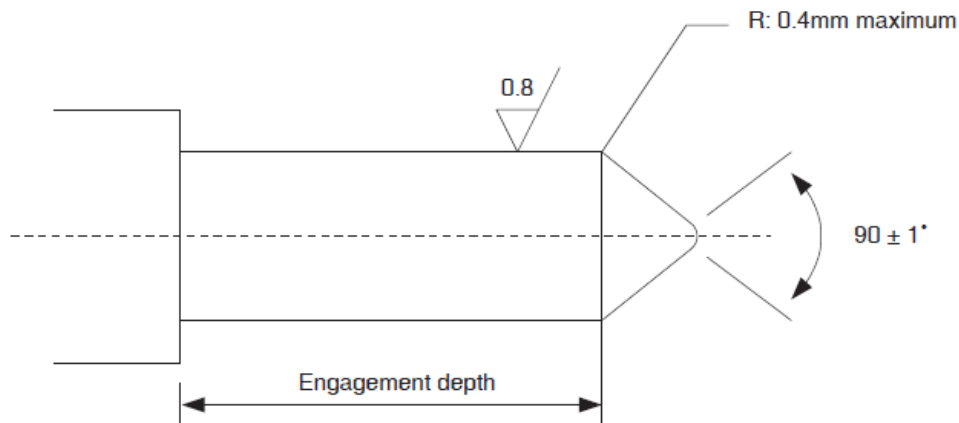

2.4 COUPLING PROOF TORQUE TEST

Ref. Coupling Proof Torque in the ESCC Generic Specification.

Coupling Proof Torque: 170N.cm.

2.5 MATING AND UNMATING FORCES TEST

Ref. Mating and Unmating Forces in the ESCC Generic Specification.

Maximum torque during mating or unmating: 24N.cm.

2.6 ELECTRICAL MEASUREMENTS AT ROOM, HIGH AND LOW TEMPERATURES

The measurements shall be performed at room, high and low temperatures.

2.6.1 Room Temperature Electrical Measurements

The measurements shall be performed at $T_{amb} = +22 \pm 3^{\circ}\text{C}$.

Characteristics	Symbols	Test Method and Conditions	Limits		Units
			Min	Max	
Voltage Standing Wave Ratio	VSWR	ESCC No. 3403 f = 0 to 31.5GHz	-	Note 1	-
Resistance	R	Test current < 50mA DC to 2kHz max.	47.5	52.5	Ω

NOTES:

1. The limits for VSWR are specified in Component Type Variants and Range of Components.

2.6.2 High and Low Temperatures Electrical Measurements

The measurements shall be performed at $T_{amb} = +125 (+0 -3)^{\circ}\text{C}$ and $T_{amb} = -55 (+3 -0)^{\circ}\text{C}$.

Characteristics	Symbols	Test Method and Conditions (Note 1)	Limits		Units
			Min	Max	
Temperature Coefficient of Resistance	TC_R	Test current < 50mA DC to 2kHz max.	-	3×10^{-4}	$\Omega/\Omega/^{\circ}\text{C}$

NOTES:

1. Measurements shall be performed during Screening Tests on a sample of 2 components. In the event of any failure a 100% inspection shall be performed.

2.7 PARAMETER DRIFT VALUES

Unless otherwise specified, the measurements shall be performed at $T_{amb} = +22 \pm 3^{\circ}\text{C}$.

The test methods and test conditions shall be as per the corresponding test defined in Room Temperature Electrical Measurements.

The drift values (Δ) shall not be exceeded for each characteristic where specified. The corresponding absolute limit values for each characteristic shall not be exceeded.

Characteristics	Symbols	Drift Value Δ	Units
Voltage Standing Wave Ratio	$\frac{\Delta\text{VSWR}}{\text{VSWR}}$	± 2	%
Resistance	ΔR	± 250	m Ω

2.8 INTERMEDIATE AND END-POINT ELECTRICAL MEASUREMENTS

Unless otherwise specified, the measurements shall be performed at $T_{amb} = +22 \pm 3^{\circ}C$.

Unless otherwise specified, test methods and test conditions shall be as per the corresponding test defined in Room Temperature Electrical Measurements.

The drift values (Δ) shall not be exceeded for each characteristic where specified. The corresponding absolute limit values for each characteristic shall not be exceeded.

Test Reference per ESCC No. 3403	Characteristics	Symbols	Limits		Units	
			Min	Max		
Vibration Initial Measurements	Resistance	R	47.5	52.5	Ω	
	Voltage Standing Wave Ratio	VSWR	-	Note 1	-	
	Measurements during last cycle	-	No discontinuity > 0.5ms No open or short circuit		-	
	Final Measurements	Resistance	R	47.5	52.5	Ω
Mechanical Shock Initial Measurements	Resistance (Note 2)	R	47.5	52.5	Ω	
	Voltage Standing Wave Ratio (Note 2)	VSWR	-	Note 1	-	
	Final Measurements	Resistance	R	47.5	52.5	Ω
	Resistance Drift (from initial measurement)	ΔR	-	± 250	m Ω	
Rapid Change of Temperature Initial Measurements	Voltage Standing Wave Ratio	VSWR	-	Note 1	-	
	Final Measurements	Voltage Standing Wave Ratio	VSWR	-	Note 1	-
	Resistance	R	47.5	52.5	Ω	
	Resistance Drift (from initial measurement)	ΔR	-	± 250	m Ω	
Rapid Change of Temperature Final Measurements	Voltage Standing Wave Ratio	VSWR	-	Note 1	-	
	VSWR Drift (from initial measurement)	$\frac{\Delta VSWR}{VSWR}$	-	± 2	%	
	Voltage Standing Wave Ratio	VSWR	-	Note 1	-	
	VSWR Drift (from initial measurement)	$\frac{\Delta VSWR}{VSWR}$	-	± 2	%	

Test Reference per ESCC No. 3403	Characteristics	Symbols	Limits		Units	
			Min	Max		
Climatic Sequence Initial Measurements	Resistance (Note 2)	R	47.5	52.5	Ω	
	Voltage Standing Wave Ratio (Note 2)	VSWR	-	Note 1	-	
	Measurements during Dry Heat	Temperature Coefficient of Resistance	TC_R	-	3×10^{-4}	$\Omega/\Omega/^\circ\text{C}$
	Measurements during Cold	Temperature Coefficient of Resistance	TC_R	-	3×10^{-4}	$\Omega/\Omega/^\circ\text{C}$
Final Measurements	Resistance	R	47.5	52.5	Ω	
	Resistance Drift (from initial measurement)	ΔR	-	± 250	m Ω	
	Voltage Standing Wave Ratio	VSWR	-	Note 1	-	
	VSWR Drift (from initial measurement)	$\frac{\Delta VSWR}{VSWR}$	-	± 2	%	
Operating Life Initial Measurements	Resistance (Note 2)	R	47.5	52.5	Ω	
	Voltage Standing Wave Ratio (Note 2)	VSWR	-	Note 1	-	
	Final Measurements	Resistance	R	47.5	52.5	Ω
		Resistance Drift (from initial measurement)	ΔR	-	± 250	m Ω
Voltage Standing Wave Ratio		VSWR	-	Note 1	-	
VSWR Drift (from initial measurement)		$\frac{\Delta VSWR}{VSWR}$	-	± 2	%	
RF Leakage	RF leakage f = 0 to 31.5GHz	E	-85	-	dBi	
Peak Power Final Measurements	Resistance	R	47.5	52.5	Ω	

NOTES:

1. The limits for VSWR are as specified in Component Type Variants and Range of Components.
2. This test need not be repeated. The most recent result from the previous test may be used instead.

2.9 BURN-IN CONDITIONS

Characteristics	Symbols	Test Conditions	Units
Ambient Temperature	T_{amb}	+125	°C
Power	P_{in}	0	W

2.10 OPERATING LIFE CONDITIONS

Characteristics	Symbols	Test Conditions	Units
Ambient Temperature	T_{amb}	+25	°C
Power	P_{in}	1	W
Frequency	f_{in}	Note 1	-

NOTES:

1. Operating Life may be performed at DC, 10GHz, 18GHz or 22GHz.