

QUICKFUSIO™ SERIES

Section 3 Table of Contents

INTRODUCTION

Introduction..... 3-2 to 3-3

Range Overview 3-4

Product Selection Guide 3-5

CHARACTERISTICS

Technical Characteristics 3-6 to 3-7

Electrical Characteristics 3-6

Mechanical Characteristics 3-7

Environmental Characteristics 3-7

GigaBit Ethernet..... 3-8 to 3-9

Product Overview 3-10

INSERTS

Insert Overview..... 3-11

How to QuickFusio™ 3-12

Tie-Wrap Output Positions, Contact Termination & Coding 3-13

Weight - QuickFusio 3-14

Weight - QuickFusio+ 3-15

Dimensions..... 3-16 to 3-18

CONTACTS

Electrical Contacts 3-19

LuxCis® Arinc Fiber Optic Contacts..... 3-20

Q-MTitian™ Fiber Optic Contacts 3-21

Accessories 3-22

Spare Parts & Tools..... 3-23

Introduction

INTRODUCTION

Radiall's experience in rectangular connectors and ability to design innovative solutions make the QuickFusio™ series the perfect miniature interconnect solution for cabin interiors and EWIS aerospace applications. Combining high performance with competitive costs, this lightweight, tool-less connector features The Radiall Touch: one finger mating - in a snap!

The QuickFusio™ series is a versatile range that covers any wiring systems including harness-to-harness and equipment-to-harness. The QuickFusio™ series is available in different shell styles in order to make installing the miniature connector in any aircraft area feasible.



PANEL MOUNT

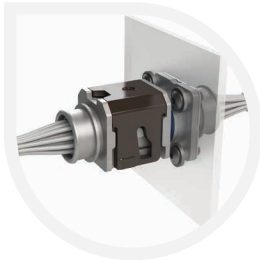

BOX MOUNT

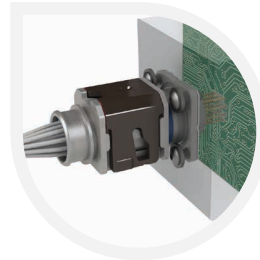

BUNDLE MOUNT

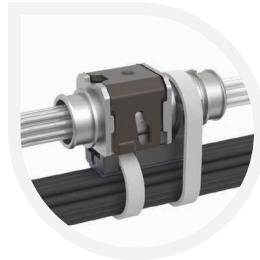

STRUCTURE MOUNT



APPLICATIONS

The QuickFusio™ series is the perfect solution for major commercial aerospace and defense OEMs and is perfectly suited for:

- Cabin Interiors: In Flight Entertainment (IFE), Lighting, Seat Actuators, In-Seat Power Supply, Passenger Service Units (PSU)
- Electrical Wiring Systems (EWIS)
- Sensors



Introduction

FEATURES & BENEFITS

*Competitive Cost*

QuickFusio™ series is optimized to meet customer expectations in terms of competitive price positioning. The use of standard SAE-AS-38999 contacts in QuickFusio™ inserts and the unique mating mechanism enables quick mating and reduces overall cost.

*Simple Wiring*



By squaring a circle, Radiall has created an innovative design compatible with standard SAE-AS-38999 size 11 accessories. The unique design covers any type of wiring combination and is easy to install due to the Radiall Touch: one finger mating – in a snap!

*Lightweight Solution*

Extremely compact, QuickFusio™ series is 20% lighter and 40% smaller than the competition. This small, dense solution eliminates wasted space and reduces the overall weight. QuickFusio™ is only 20 grams per pair when equipped with size 22 contacts.

Introduction

RANGE OVERVIEW

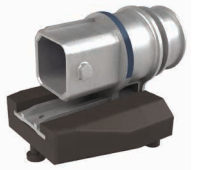
PLUGS	RECEPTACLES (MATEABLE WITH ALL PLUGS)			
	Receptacle Outputs	Square Flange Receptacle for Panel and Box Mount ^[1]	In-Line Receptacle and Platform for Bundle Mount	In-Line Receptacle and Platform for Structure Mount ^[2]
 Threaded Accessory	Threaded Output			
 Banding Platform	Banding Platform Output			
 Banding Platform and Tie-Wrap	Banding Platform and Tie-Wrap Output			
	Short Receptacle Output with Straight PC Tail Contacts			
	Short Receptacle Output with Right Angle PC Tail Contacts			

Notes

1. Sealed square flange versions will soon complete the existing square flange receptacle range. Please contact your local representative for additional information.
2. Shell style not yet available. Please contact your local representative for additional information.

Introduction

PRODUCT SELECTION GUIDE
TWO INNOVATIVE SOLUTIONS TO MEET CUSTOMERS' NEEDS

To meet all customers' needs and expectations, the QuickFusio™ series is available in two different versions: QuickFusio and QuickFusio+.

- The QuickFusio connector offers the perfect balance between extreme competitive cost and performance needed in pressurized environments, especially in cabin applications.
- Qualified in accordance to EWIS standard, the QuickFusio+ connector meets even more stringent requirements and is suitable for both pressurized and non-pressurized environments.

To choose your connector, determine your performance requirements below:

PERFORMANCE	QUICKFUSIO	QUICKFUSIO+
Operating Temperature	-55 °C to +125 °C (-67 °F to +257 °F)	-65 °C to +175 °C (-85 °F to +347 °F)
Altitude Immersion	No Sealing	55,000 ft
DWV at 70,000 ft (Mated Connector)	325 Vrms	1,000 Vrms
Salt Spray	48 h	96 h
Vibrations	20 g Sinus - 4 Hours on each of the 3 Axis	27.8 grms - 8 Hours on each of the 3 Axis
Lightning Strike	N/A	5 KA - 1,600 V
Shell to Shell Conductivity	10 mΩ max	2.5 mΩ max

HOW TO DIFFERENTIATE YOUR CONNECTORS?

QUICKFUSIO

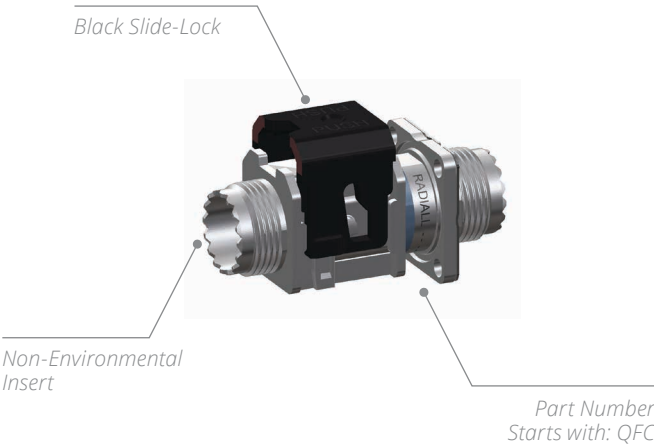

QUICKFUSIO+

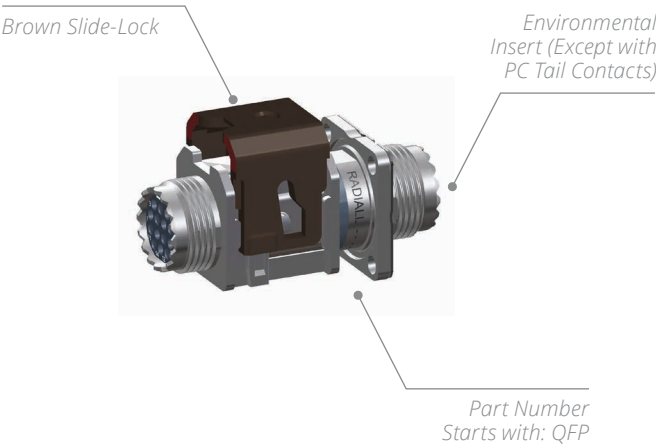

Characteristics

TECHNICAL CHARACTERISTICS

ELECTRICAL CHARACTERISTICS

CURRENT RATING	CONTACT SIZE	CABLE GAUGE	QuickFusio	QuickFusio+
			MAX CURRENT AMPS (A)	MAX CURRENT AMPS (A)
23		AWG22	5	5
		AWG24	3	3
		AWG26	2	2
22		AWG22	5	5
		AWG24	3	3
		AWG26	2	2
20		AWG20	7.5	7.5
		AWG22	5	5
		AWG24	3	3
16		AWG16	13	13
		AWG18	10	10
		AWG20	7.5	7.5
12		AWG12	23	23
		AWG14	17	17
		AWG16	13	13

DIELECTRIC WITHSTANDING VOLTAGE (DWV)	At Sea Level	All Inserts	QuickFusio	QuickFusio+
			1,500 Vrms	1,500 Vrms
		Insert 22	1,000 Vrms	1,300 Vrms
		Insert Q1	N/A	1,000 Vrms
		At 70,000 ft	All inserts	325 Vrms
		Insert 22	125 Vrms	325 Vrms
		Insert Q1	N/A	125 Vrms
		INSULATION RESISTANCE	Ambient Temperature	> 5,000 MΩ
At High Temperature	> 200 MΩ at 125 °C		> 200 MΩ at 175 °C	
LIGHTNING STRIKE	Current Pulse	N/A	5KA	
	Voltage Pulse	N/A	1,600 V	

EMI SHIELDING EFFECTIVENESS	FREQUENCY (MHz)	QuickFusio	QuickFusio+
		LEAKAGE ATTENUATION (dB)	LEAKAGE ATTENUATION (dB)
	100	65	65
	200	63	63
	300	63	63
	400	62	62
	500	60	60
	600	55	55
	800	50	50
	1000	50	50

SHELL TO SHELL CONDUCTIVITY	QuickFusio	QuickFusio+
	10 mΩ max	2.5 mΩ max
MAGNETIC PERMEABILITY	< 2 μ	< 2 μ

Characteristics

MECHANICAL CHARACTERISTICS

		QuickFusio		QuickFusio+	
		RETENTION FORCE	MAX DISPLACEMENT	RETENTION FORCE	MAX DISPLACEMENT
CONTACT RETENTION	CONTACT SIZE				
	23	44 N	0.30 mm	44 N	0.30 mm
	22	44 N		44 N	
	20	67 N		67 N	
	16	110 N		110 N	
12	110 N	110 N			

	CONTACT SIZE	MAXIMUM INSERTION FORCE	MAXIMUM EXTRACTION FORCE	MAXIMUM INSERTION FORCE	MAXIMUM EXTRACTION FORCE
		CONTACT INSERTION EXTRACTION FORCE			
	23	44 N	44 N	44 N	44 N
	22	44 N	44 N	44 N	44 N
	20	89 N	89 N	89 N	89 N
	16	89 N	89 N	89 N	89 N
	12	133 N	133 N	133 N	133 N

MECHANICAL ENDURANCE			QuickFusio	QuickFusio+
			500 Mating Cycles	500 Mating Cycles
VIBRATIONS	Square Flange Receptacle and Universal Plugs	Electrical and Optical Contacts	Acceleration 20 g Sinus (4 Hours on each of the 3 Axis) EN 2591 - 403	Acceleration 27.8 g (8 Hours on each of the 3 Axis) EN 2591 - 403
		Quadrax Contact	N/A	Acceleration 16.91 g (8 Hours on each of the 3 Axis) EN 2591 - 403
	In-Line Receptacle and Universal Plugs	-	Acceleration 11.33 g ⁽¹⁾ RTCA-DO-160G Test Curve E1	Acceleration 11.33 g ⁽¹⁾ RTCA-DO-160G Test Curve E1 Windmilling & High Power Test
SHOCK - 3 SHOCKS ON EACH AXIS			Shock Amplitude 50 Half Sinus/ Duration 11 ms	Shock Amplitude 50 Half Sinus/ Duration 11 ms
INSERT RETENTION IN SHELL			254 N	254 N

ENVIRONMENTAL CHARACTERISTICS

	QuickFusio	QuickFusio+
OPERATING TEMPERATURE	-55 °C to +125 °C (-67 °F to +257 °F)	-65 °C to +175 °C (-85 °F to +347 °F)
TEMPERATURE LIFE	1,000 Hours at 125 °C	1,000 Hours at 175 °C
SALT SPRAY	48 Hours	96 Hours
ALTITUDE IMMERSION (ALL INSERTS EXCEPT 22)	No Sealing	55,000 ft
SEAL LEAKAGE (CLASS B) - INSERT 22	N/A	Resistant to Running Water
FLAMMABILITY	EN 2591-317 FAR 25,853	EN 2591-317 FAR 25,853
SMOKE AND TOXICITY	EN 2591-317 FAR 25,853 (F)	EN 2591-317 FAR 25,853 (F)

Notes

1. Minimum level validated by Radiall, other levels can be tested on demand.

Characteristics

GIGABIT ETHERNET

To respond to the growing demand in civil aerospace for faster digital networks, Radiall has combined Gigabit Ethernet protocols into a miniature connector, opening new perspectives for cabin and avionics networks. To meet customers' every expectations, Radiall developed two different solutions:

- A 10 Gb/s offer
- A 1 Gb/s offer

I. QUICKFUSIO™ 10 GB/S

Available with QuickFusio and QuickFusio+

QuickFusio™ 10 Gb/s meets cat6A requirements following TIA568 C.2 specification and offers excellent high frequency and digital performance. Capitalizing on its expertise and ability to innovate, Radiall specifically designed a new insert called XG, which provides efficient crosstalk shielding between the pairs of cables.

QuickFusio™ 10 Gb/s was successfully tested with cables measuring up to 68 meters fitted with 6 QuickFusio connections. The results shown below concern a set-up based on Arinc 800 part 4 specification, tested with a Gore Ethernet cable RCN9047-26 equipped as follow [1]:

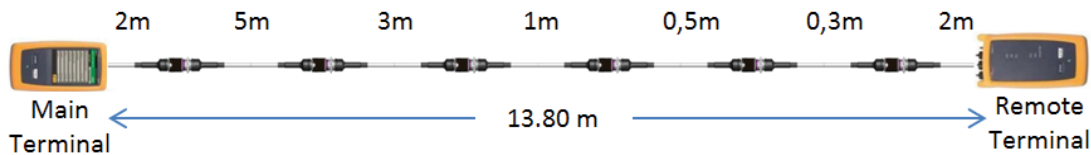

They proved QuickFusio™ 10 Gb/s to effectively minimize crosstalk, prevent perturbation from the environment, ensure reliability and maintain signal integrity.

Transmission Characteristics:

EYE DIAGRAM

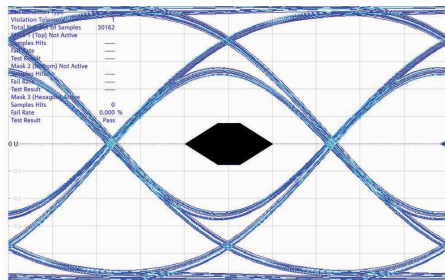

NEAR-END CROSSTALK (NEXT):

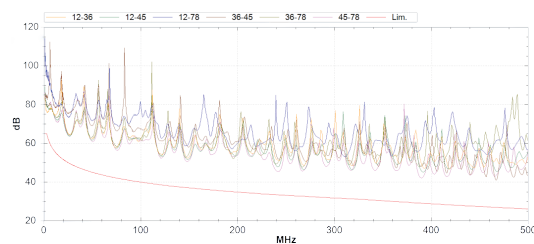

INSERTION LOSS (IL):

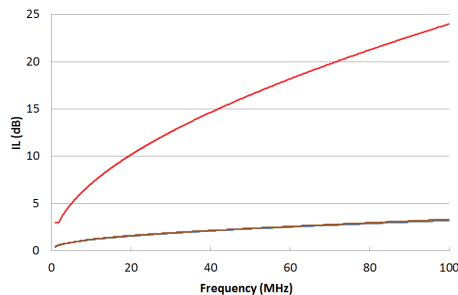

RETURN LOSS (RL):

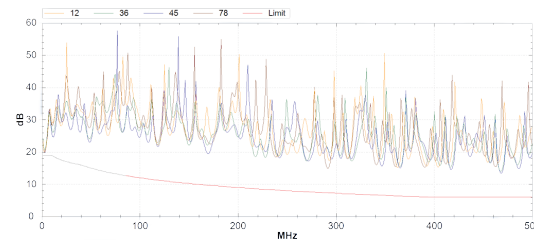

Notes

Test reports are available upon request.

1. For specific information on the Ethernet offer for QuickFusio™ equipped with PC tail contacts, please ask your local representative.

Characteristics

II. QUICKFUSIO™ 1 GB/S

The 1 Gb/s offer passes the Ethernet cat5e performance level due to a specific layout configuration developed in the insert IG, which preserves the signal integrity while minimizing crosstalk, insertion loss and return loss effects.

Single Ethernet cable configuration (available with QuickFusio and QuickFusio+)

The single Ethernet configuration was tested with the same configuration (based on Arinc 800 part 4 specification) as QuickFusio™ 10 Gb/s. [1]

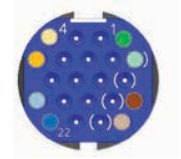

Insert IG Contact Mapping

Transmission Characteristics:

NEAR-END CROSSTALK (NEXT):

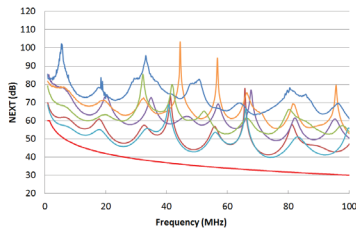

INSERTION LOSS (IL):

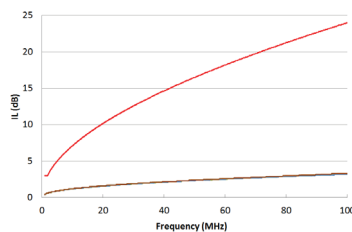

RETURN LOSS (RL):

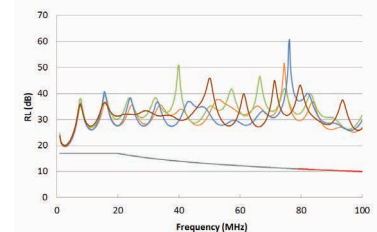

DOUBLE ETHERNET CABLE CONFIGURATION (AVAILABLE WITH QUICKFUSIO)

For this insert layout, the following configuration was tested with a Thermax MX10G-26FLX Ethernet cable. [1]

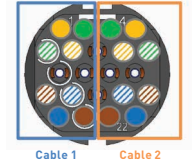
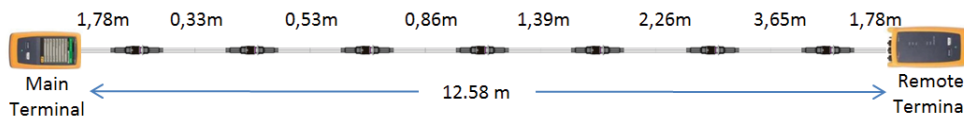

Insert IG Contact Mapping

Transmission Characteristics:

NEAR-END CROSSTALK (NEXT):

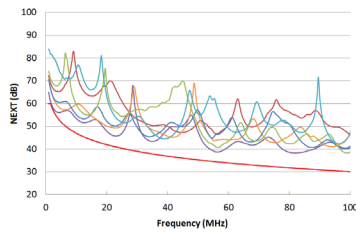

INSERTION LOSS (IL):

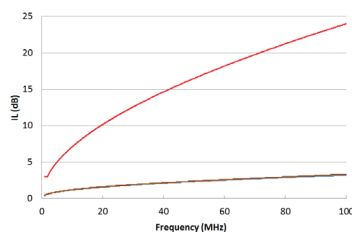

RETURN LOSS (RL):

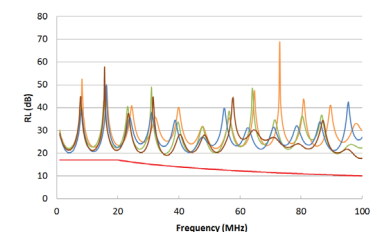

Refer to mounting instruction ref. MI IN 27 00004 EN (QuickFusio) and ref. MI IN 27 00001 EN (QuickFusio+) to ensure proper cable and connector assembly. Test reports are available upon request.

Notes

1. For specific information on the Ethernet offer for QuickFusio™ equipped with PC tail contacts, please ask your local representative.

Inserts

PRODUCT OVERVIEW

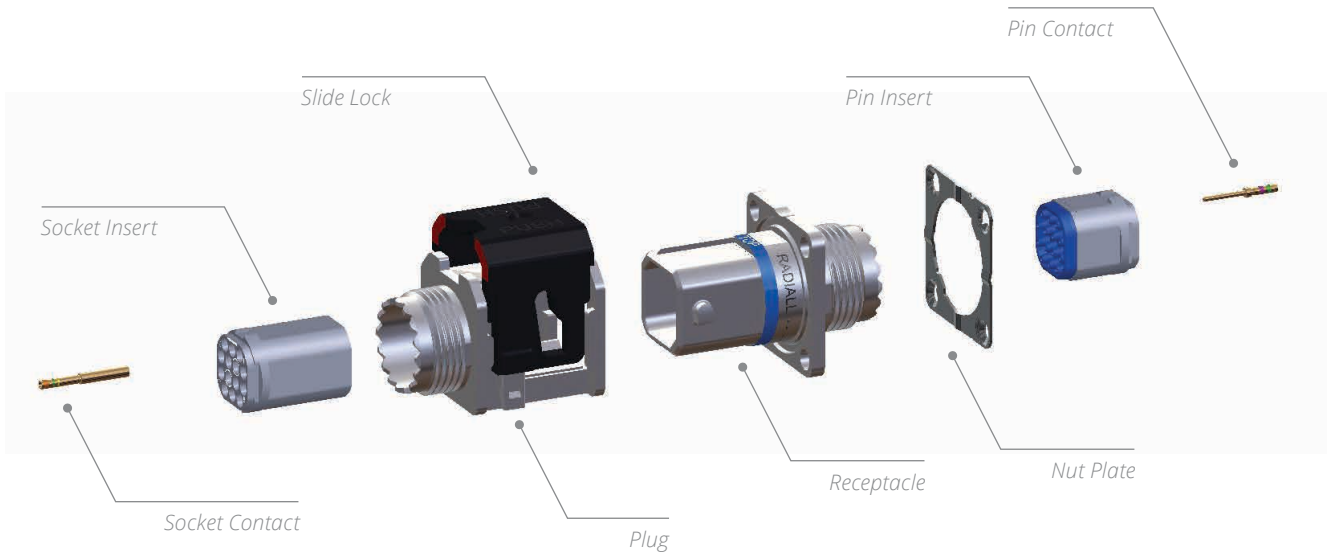

MATERIALS AND PLATING

Plug and Receptacle

- Shell: high grade thermoplastic (nickel-plated)
- Insert retention clip: beryllium copper
- Slide lock (plug): high grade thermoplastic
- Nut plate (receptacle): stainless steel

Insert

- Grommet and interfacial seal: fluorosilicone elastomer
- Insulators: high grade thermoplastic
- Retention clip: metallic

Contacts

- Copper alloy, gold-plated over nickel

Bundle Mount Platform (For In-Line Receptacle)

- Silicone pad: silicone rubber
- Cradle: high grade thermoplastic



Inserts

INSERT OVERVIEW

NON-ENVIRONMENTAL INSERTS

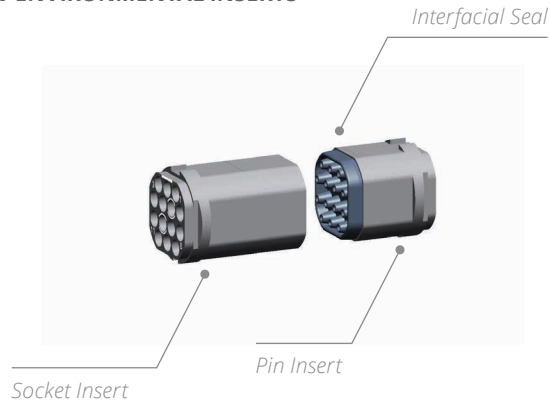

ENVIRONMENTAL INSERTS

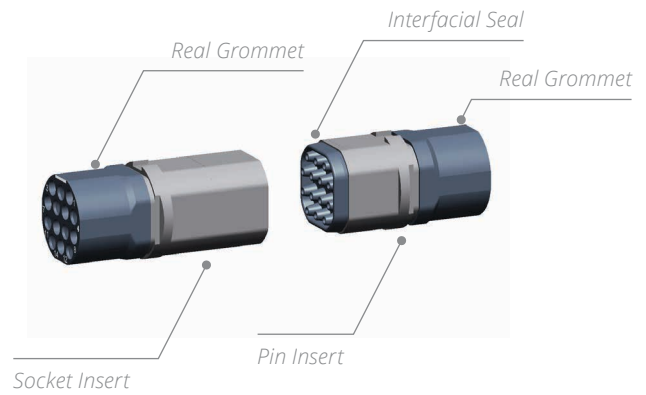

INSERT ARRANGEMENTS

Except for F4 and Q1 inserts, all inserts are available in environmental and non-environmental versions.

Insert Name 22 22 × Size 23 Contacts	Insert Name 14 14 × Size 22 Contacts	Insert Name 07 7 × Size 20 Contacts	Insert Name F4 4 × LuxCis® Arinc 801 Contacts
Insert Name M4 3 × Size 20 Contacts 1 × Size 12 Contact	Insert Name M9 2 × Size 16 Contacts 7 × Size 22 Contacts	Insert Name 04 4 × Size 16 Contacts	Insert Name Q1 1 × Size 8 Quadrax Contact
			<p>● Insert Only Available:</p> <ul style="list-style-type: none"> • In environmental version • With accessory thread or banding platform rear output shell <p>● Insert Only Available:</p> <ul style="list-style-type: none"> • In non-environmental version
Insert Name IG For 1 Gb/s Ethernet Applications	Insert Name XG For 10 Gb/s Ethernet Applications [1]		

Notes

1. To order insert XG, please contact your local representative.

Inserts

HOW TO ORDER QUICKFUSIO™

QuickFusio™ is delivered fully assembled including the shell, with insert mounted and with or without contacts based on your selection.

Tips to help you in your selection:

- QuickFusio+ connectors are fitted with environmental inserts (except for short receptacles with PC tail contacts which are fitted with non-environmental inserts).
- QuickFusio connectors are always fitted with non-environmental inserts.
- For crimp contacts, you can use either pin or socket inserts in QuickFusio and QuickFusio+ plugs or receptacles (however, if scoop proof option is needed, please use pin inserts in receptacles).
- PC tail contacts are only available as pin PC tail contacts in short receptacle rear output (if PC tails are selected then all the cavities are populated).
- Short receptacle is dedicated to PC tail terminations. If crimp contacts are needed in short receptacle, please ask your local representative.

QFC

SERIES PREFIX

QFC: QuickFusio

QFP: QuickFusio+

SHELL SIZE

5: One size available

SHELL TYPE ^[1]

PN: Plug (Nickel-plated)

RN: Square flange receptacle (nickel-plated)

REAR OUTPUT

1: Short receptacle ^[2]

2: Accessory thread

3: Banding platform

A: Banding platform and tie-wrap (orientation 0°) ^[1]

INSERT CLASS ^[3]

N: Non-environmental (without grommet, always the interfacial seal on pin insert)

E: Environmental (for QuickFusio+ only)

INSERT NAME

Refer to page 3-11 to select your insert name.

INSERT TYPE ^[4]

P: Pin inserts

S: Socket inserts

CONTACT TERMINATION ^[5]

X: Contact not supplied with the connector

S: Crimp contacts are supplied with connector

YB: Gold finish straight PC tail contacts ^{[6] [7] [8]}

GB: Gold finish right angle PC tail contacts ^{[6] [7] [8]}

RB: Pure tin straight PC tail contacts ^{[6] [7] [8]}

TB: Pure tin right angle PC tail contacts ^{[6] [7] [8]}

CODING

Refer to page 3-13 to select your coding (A to N).

Notes

1. For other options, please contact your local representative
2. Not available with shell types WN and LN
3. Refer to the table to the right to select your insert class.
4. For F4 insert: pin inserts only available on plug side and socket inserts with sleeve holder on receptacle side.
5. Size 8 and optical contacts must be ordered separately
6. F4 and Q1 inserts are not available with PC tail contacts
7. Only available with short receptacle rear output ^[1]
8. Refer to page 3-13 for PC tail lengths

CONTACT TERMINATION	QUICKFUSIO	QUICKFUSIO+	
	NON-ENVIRONMENTAL	NON-ENVIRONMENTAL	ENVIRONMENTAL
X	√	-	√
S	√	-	√
YB to TB	√	√	-

Inserts

TIE-WRAP OUTPUT POSITIONS, CONTACT TERMINATIONS & CODING

TIE-WRAP OUTPUT ANGULAR POSITIONS

For tie-wrap output orientation 90°, 180° or 270° please contact your local representative for additional information.

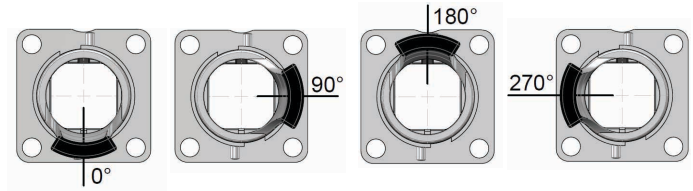

CONTACT TERMINATION

STRAIGHT PC TAIL CONTACT TERMINATION SIZE #23 TO SIZE #12 CONTACTS

MINI LENGTH E MM (INCH)	MINI LENGTH H MM (INCH)	GOLD	PURE TIN (ROHS)
14.25 (0.561)	7.42 (0.292)	YB	RB

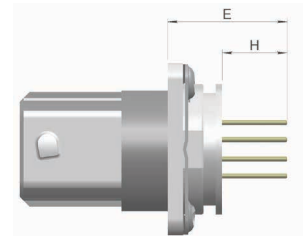

RIGHT ANGLE PC TAIL CONTACT TERMINATION SIZE #23 TO SIZE #12 CONTACTS

MINI LENGTH E MM (INCH)	MINI LENGTH H MM (INCH)	GOLD	PURE TIN (ROHS)
12.19 (0.480)	4.43 (0.174)	GB	TB

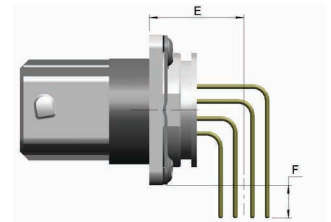

CODING

The QuickFusio™ series is available in 6 different codings through specific mechanical shapes. Each of these mechanical codings is associated with one particular color, which enables quick and easy wiring. One universal N coding, mateable with the 6 other codings, is also available.

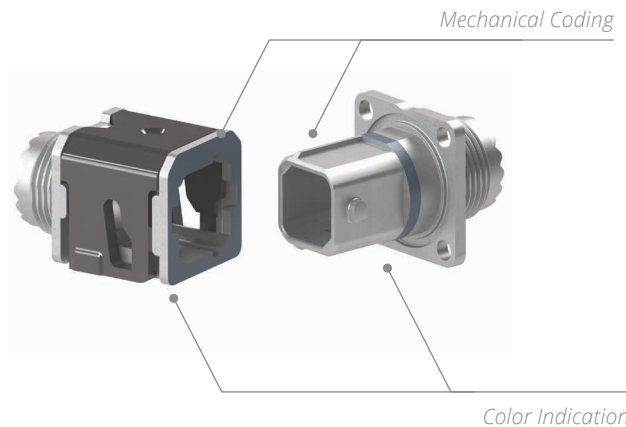

	CODING A	CODING B	CODING C	CODING D	CODING E	CODING F	CODING N UNIVERSAL CODING
Color and Mechanical Shape Coding							

Inserts

WEIGHT - QUICKFUSIO

PLUG ⁽¹⁾				
INSERT NAME	INSERT TYPE	THREADED ACCESSORY	BANDING PLATFORM	BANDING PLATFORM & TIE WRAP
22 /IG	Pin	8.50 g (0.30 oz)	8.60 g (0.30 oz)	8.90 g (0.31 oz)
22 /IG	Socket	9.20 g (0.33 oz)	9.30 g (0.33 oz)	9.60 g (0.34 oz)
14	Pin	8.50 g (0.30 oz)	8.60 g (0.30oz)	8.90 g (0.31 oz)
14	Socket	9.20 g (0.33 oz)	9.30 g (0.33 oz)	9.60 g (0.34 oz)
07	Pin	8.15 g (0.29 oz)	8.25 g (0.29 oz)	8.55 g (0.30 oz)
07	Socket	8.60 g (0.30 oz)	8.70 g (0.30 oz)	9.00 g (0.32 oz)
04	Pin	8.15 g (0.29 oz)	8.25 g (0.29 oz)	8.55 g (0.30 oz)
04	Socket	8.60 g (0.30 oz)	8.70 g (0.30 oz)	9.00 g (0.32 oz)
M4	Pin	8.15 g (0.29 oz)	8.25 g (0.29 oz)	8.55 g (0.30 oz)
M4	Socket	8.60 g (0.30 oz)	8.70 g (0.30 oz)	9.00 g (0.32 oz)
M9	Pin	8.55 g (0.302 oz)	8.65 g (0.305 oz)	8.95 g (0.316 oz)
M9	Socket	9.25 g (0.326 oz)	9.35 g (0.330 oz)	9.65 g (0.340 oz)
XG	Pin	8.45 g (0.30 oz)	8.55 g (0.30 oz)	8.85 g (0.31 oz)
XG	Socket	9.30 g (0.33 oz)	9.40 g (0.33 oz)	9.70 g (0.34 oz)

SQUARE FLANGE RECEPTACLE ⁽¹⁾					
INSERT NAME	INSERT TYPE	THREADED ACCESSORY	BANDING PLATFORM	BANDING PLATFORM & TIE WRAP	SHORT RECEPTACLE
22 /IG	Pin	7.20 g (0.25 oz)	7.30 g (0.26 oz)	7.60 g (0.27 oz)	6.75 g (0.24 oz)
22 /IG	Socket	7.85 g (0.28 oz)	7.95 g (0.28 oz)	8.25 g (0.29 oz)	N/A
14	Pin	7.20 g (0.25 oz)	7.30 g (0.26 oz)	7.60 g (0.27 oz)	6.75 g (0.24 oz)
14	Socket	7.85 g (0.28 oz)	7.95 g (0.28 oz)	8.25 g (0.29 oz)	N/A
07	Pin	6.85 g (0.25 oz)	6.95 g (0.25 oz)	7.25 g (0.26 oz)	6.40 g (0.23 oz)
07	Socket	7.30 g (0.26 oz)	7.40 g (0.26 oz)	7.70 g (0.27 oz)	N/A
04	Pin	6.85 g (0.25 oz)	6.95 g (0.25 oz)	7.25 g (0.26 oz)	6.40 g (0.23 oz)
04	Socket	7.30 g (0.26oz)	7.40 g (0.26 oz)	7.70 g (0.27 oz)	N/A
M4	Pin	6.85 g (0.25 oz)	6.95 g (0.25 oz)	7.25 g (0.26 oz)	6.40 g (0.23 oz)
M4	Socket	7.30 g (0.26 oz)	7.40 g (0.26 oz)	7.70 g (0.27 oz)	N/A
M9	Pin	7.25 g (0.256 oz)	7.35 g (0.259 oz)	7.65 g (0.270 oz)	9.40 g (0.332 oz)
M9	Socket	7.90 g (0.279 oz)	8.00 g (0.282 oz)	8.30 g (0.293 oz)	N/A
XG	Pin	7.10 g (0.25 oz)	7.20 g (0.25 oz)	7.50 g (0.27 oz)	6.65 g (0.24 oz)
XG	Socket	7.95 g (0.28 oz)	8.05 g (0.28 oz)	8.35 g (0.30 oz)	N/A

IN-LINE RECEPTACLE ⁽¹⁾⁽²⁾				
INSERT NAME	INSERT TYPE	THREADED ACCESSORY	BANDING PLATFORM	BANDING PLATFORM & TIE WRAP
22 /IG	Pin	5.40 g (0.19 oz)	5.50 g (0.19 oz)	5.80 g (0.20 oz)
22 /IG	Socket	6.05 g (0.21 oz)	6.15 g (0.22 oz)	6.45 g (0.23 oz)
14	Pin	5.40 g (0.19 oz)	5.50 g (0.19 oz)	5.80 g (0.20 oz)
14	Socket	6.05 g (0.21 oz)	6.15 g (0.22 oz)	6.45 g (0.23 oz)
7	Pin	5.05 g (0.18 oz)	5.15 g (0.18 oz)	5.45 g (0.19 oz)
7	Socket	5.50 g (0.19 oz)	5.60 g (0.20 oz)	5.90 g (0.21 oz)
4	Pin	5.05 g (0.18 oz)	5.15 g (0.18 oz)	5.45 g (0.19 oz)
4	Socket	5.50 g (0.19 oz)	5.60 g (0.20 oz)	5.90 g (0.21 oz)
M4	Pin	5.05 g (0.18 oz)	5.15 g (0.18 oz)	5.45 g (0.19 oz)
M4	Socket	5.50 g (0.19 oz)	5.60 g (0.20 oz)	5.90 g (0.21 oz)
M9	Pin	5.45 g (0.192 oz)	5.55 g (0.196 oz)	5.85 g (0.206 oz)
M9	Socket	6.10 g (0.215 oz)	6.20 g (0.219 oz)	6.50 g (0.229 oz)
XG	Pin	5.30 g (0.19 oz)	5.40 g (0.19 oz)	5.70 g (0.20 oz)
XG	Socket	6.15 g (0.22 oz)	6.25 g (0.22 oz)	6.55 g (0.23 oz)

Notes

1. Connector weight includes non-environmental insert only without contacts.
2. Connector weight does not include the bundle mount platform. Bundle mount platform weight is 3.35 g (0.12 oz).

Inserts

WEIGHT - QUICKFUSIO+

PLUG ⁽¹⁾				
INSERT NAME	INSERT TYPE	THREADED ACCESSORY	BANDING PLATFORM	BANDING PLATFORM & TIE WRAP
22 /IG	Pin	9.45 g (0.33oz)	9.55 g (0.34 oz)	9.85 g (0.35 oz)
22 /IG	Socket	10.10 g (0.36 oz)	10.20 g (0.36 oz)	10.50 g (0.377 oz)
14	Pin	9.35 g (0.33 oz)	9.45 g (0.33 oz)	9.75 g (0.34 oz)
14	Socket	10.00 g (0.35 oz)	10.10 g (0.36 oz)	10.40 g (0.37 oz)
07	Pin	9.05 g (0.32 oz)	9.15 g (0.32 oz)	9.45 g (0.33 oz)
07	Socket	9.50 g (0.34 oz)	9.60 g (0.34 oz)	9.90 g (0.35 oz)
04	Pin	9.00 g (0.32 oz)	9.10 g (0.32 oz)	9.40 g (0.33 oz)
04	Socket	9.45 g (0.33 oz)	9.55 g (0.34 oz)	9.85 g (0.35 oz)
F4	Pin	9.50 g (0.34 oz)	9.60 g (0.34 oz)	N/A
Q1	Pin	8.60 g (0.30 oz)	8.70 g (0.31 oz)	N/A
Q1	Socket	9.25 g (0.33 oz)	9.35 g (0.33 oz)	N/A
M4	Pin	9.05 g (0.32 oz)	9.15 g (0.32 oz)	9.45 g (0.33 oz)
M4	Socket	9.50 g (0.34 oz)	9.60 g (0.34 oz)	9.90 g (0.35 oz)
XG	Pin	9.50 g (0.34 oz)	9.60 g (0.34 oz)	9.90 g (0.35 oz)
XG	Socket	10.35 g (0.37 oz)	10.45 g (0.37 oz)	10.75 g (0.38 oz)

SQUARE FLANGE RECEPTACLE ⁽¹⁾					
INSERT NAME	INSERT TYPE	THREADED ACCESSORY	BANDING PLATFORM	BANDING PLATFORM & TIE WRAP	SHORT RECEPTACLE
22 /IG	Pin	8.10 g (0.29 oz)	8.20 g (0.29 oz)	8.50 g (0.30 oz)	6.75 g (0.24 oz)
22 /IG	Socket	8.80 g (0.31 oz)	8.90 g (0.31 oz)	9.20 g (0.32 oz)	N/A
14	Pin	8.00 g (0.28 oz)	8.10 g (0.29 oz)	8.40 g (0.30 oz)	6.75 g (0.24 oz)
14	Socket	8.65 g (0.31 oz)	8.75 g (0.31 oz)	9.05 g (0.32 oz)	N/A
07	Pin	7.75 g (0.27 oz)	7.85 g (0.28 oz)	8.15 g (0.29 oz)	6.40 g (0.23 oz)
07	Socket	8.20 g (0.29 oz)	8.30 g (0.29 oz)	8.60 g (0.30 oz)	N/A
04	Pin	7.70 g (0.27 oz)	7.80 g (0.28 oz)	8.10 g (0.29 oz)	6.40 g (0.23 oz)
04	Socket	8.10 g (0.29 oz)	8.20 g (0.29 oz)	8.50 g (0.30 oz)	N/A
F4	Socket	9.00 g (0.32 oz)	9.10 g (0.32 oz)	N/A	N/A
Q1	Pin	7.30 g (0.26 oz)	7.40 g (0.26 oz)	N/A	N/A
Q1	Socket	7.95 g (0.28 oz)	8.05 g (0.28 oz)	N/A	N/A
M4	Pin	7.75 g (0.27 oz)	7.85 g (0.28 oz)	8.15 g (0.29 oz)	6.40 g (0.23 oz)
M4	Socket	8.20 g (0.29 oz)	8.30 g (0.29 oz)	8.60 g (0.30 oz)	N/A
XG	Pin	8.20 g (0.29 oz)	8.30 g (0.29 oz)	8.60 g (0.30 oz)	6.65 g (0.24 oz)
XG	Socket	9.05 g (0.32 oz)	9.15 g (0.32 oz)	9.45 g (0.33 oz)	N/A

IN-LINE RECEPTACLE ⁽¹⁾⁽²⁾				
INSERT NAME	INSERT TYPE	THREADED ACCESSORY	BANDING PLATFORM	BANDING PLATFORM & TIE WRAP
22 /IG	Pin	6.30 g (0.22 oz)	6.40 g (0.23 oz)	6.70 g (0.24 oz)
22 /IG	Socket	7.00 g (0.25 oz)	7.10 g (0.25 oz)	7.40 g (0.26 oz)
14	Pin	6.20 g (0.22 oz)	6.30 g (0.22 oz)	6.60 g (0.23 oz)
14	Socket	6.85 g (0.24 oz)	6.95 g (0.25 oz)	7.25 g (0.26 oz)
7	Pin	5.95 g (0.22 oz)	6.05 g (0.21 oz)	6.35 g (0.22 oz)
7	Socket	6.40 g (0.23 oz)	6.50 g (0.23 oz)	6.80 g (0.24 oz)
4	Pin	5.90 g (0.21 oz)	6.00 g (0.21 oz)	6.30 g (0.22 oz)
4	Socket	6.30 g (0.22 oz)	6.40 g (0.23 oz)	6.70 g (0.24 oz)
F4	Socket	7.20 g (0.25 oz)	7.30 g (0.26 oz)	N/A
Q1	Pin	5.50 g (0.19 oz)	5.60 g (0.20 oz)	N/A
Q1	Socket	6.15 g (0.22 oz)	6.25 g (0.22 oz)	N/A
M4	Pin	5.95 g (0.21 oz)	6.05 g (0.21 g)	6.35 g (0.22 oz)
M4	Socket	6.40 g (0.23 oz)	6.50 g (0.23 oz)	6.80 g (0.24 oz)
XG	Pin	6.40 g (0.23 oz)	6.50 g (0.23 oz)	6.80 g (0.24 oz)
XG	Socket	7.25 g (0.26 oz)	7.35 g (0.26 oz)	7.65 g (0.27 oz)

Notes

1. Connector weight includes environmental insert without contacts, except for Short receptacles which are equipped with non-environmental inserts.
2. Connector weight does not include the bundle mount platform. Bundle mount platform weight is 3.35 g (0.12 oz).

Inserts

DIMENSIONS

PLUGS - QUICKFUSIO AND QUICKFUSIO+ (PN)

FRONT VIEW OF THE CONNECTOR

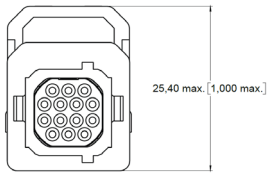

Slide Open

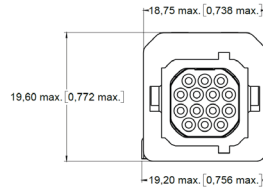

Slide Closed

STANDARD DIMENSIONS

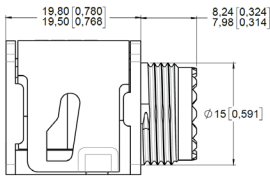

Rear Output #2
Accessory Thread

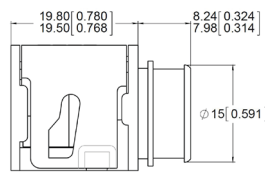

Rear Output #3
Banding Platform

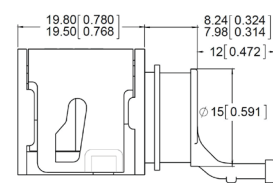

Rear Output #A
Banding Platform
and Tie-Wrap

STANDARD DIMENSIONS FOR ENVIRONMENTAL INSERTS F4 AND Q1

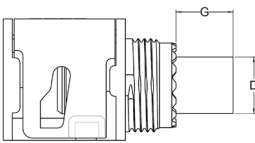

Rear Output #2
Accessory Thread

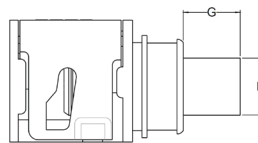

Rear Output #3
Banding Platform

INSERT NAME	GROMMET PROTRUSION (G) MAX MM (INCH)	GROMMET DIAMETER (D) MAX MM (INCH)
F4	9.50 (0.37)	10.95 (0.43)
Q1	3.50 (0.14)	11.25 (0.44)

Notes

Other inserts do not have grommet protrusion.

Inserts

SQUARE FLANGE RECEPTACLES QUICKFUSIO AND QUICKFUSIO+ (RN)

FRONT VIEW OF THE CONNECTOR

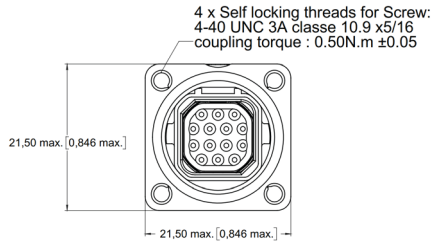

PANEL CUT-OUT

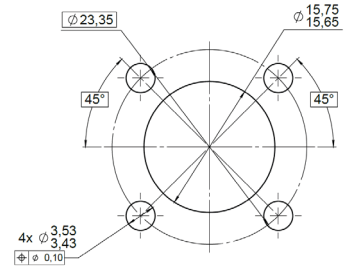

STANDARD DIMENSIONS

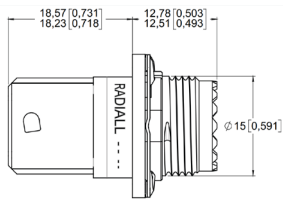

Rear Output #2
Accessory Thread

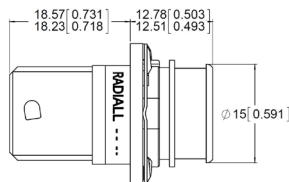

Rear Output #3
Banding Platform

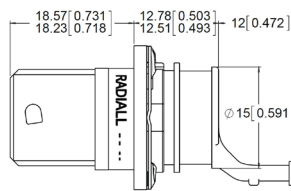

Rear Output #A
Banding Platform
and Tie-Wrap

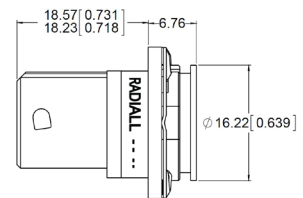

Rear Output #1
Short Receptacle

STANDARD DIMENSIONS FOR ENVIRONMENTAL INSERTS F4 AND Q1

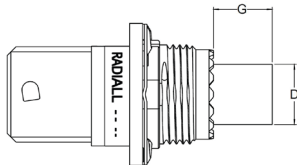

Rear Output #2
Accessory Thread

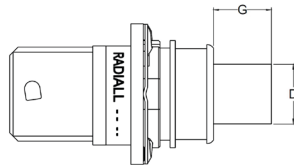

Rear Output #3
Banding Platform

INSERT NAME	GROMMET PROTRUSION (G) MAX MM (INCH)	GROMMET DIAMETER (D) MAX MM (INCH)
F4	9.50 (0.37)	10.95 (0.43)
Q1	3.50 (0.14)	11.25 (0.44)

Notes

Other inserts do not have grommet protrusion.

Inserts

IN LINE RECEPTACLES QUICKFUSIO AND QUICKFUSIO+ (WN AND LN)

FRONT VIEW OF THE CONNECTOR

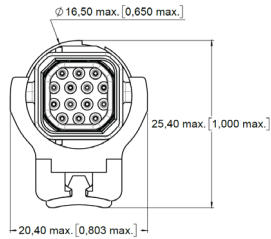

BUNDLE MOUNT PLATFORM

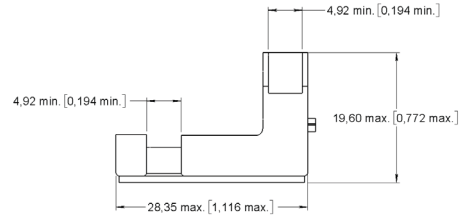

STANDARD DIMENSIONS

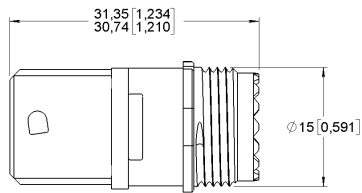

Rear Output #2
Accessory Thread

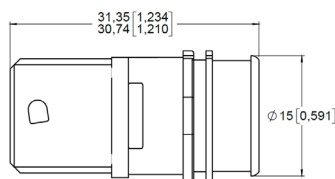

Rear Output #3
Banding Platform

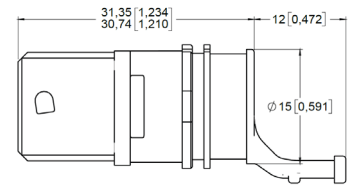

Rear Output #A
Banding Platform
and Tie-Wrap

STANDARD DIMENSIONS FOR ENVIRONMENTAL INSERTS F4 AND Q1

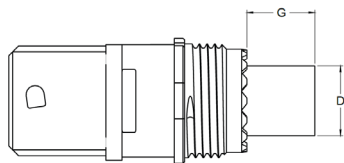

Rear Output #2
Accessory Thread

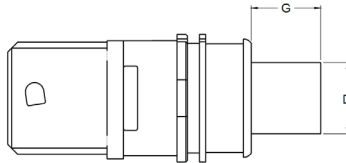

Rear Output #3
Banding Platform

INSERT NAME	GROMMET PROTRUSION (G) MAX MM (INCH)	GROMMET DIAMETER (D) MAX MM (INCH)
F4	9.50 (0.37)	10.95 (0.43)
Q1	3.50 (0.14)	11.25 (0.44)

Notes

Other inserts do not have grommet protrusion.

Contacts

ELECTRICAL CONTACTS

QuickFusio™ connectors use highly standardized contacts per SAE-AS39029 and EN3155:

- Signal and power contacts
- High frequency with coax, twinax and triax contacts
- Ethernet links with Quadrax contacts
- Fiber Optic

CONTACT SIZE	WIRE SIZE	TYPE	RADIALL PART NUMBER	STANDARD PART NUMBER	CRIMPING TOOL	POSITIONER	INS./EXT. TOOL	TYPE OF TOOL
23	AWG22 AWG24 AWG26	Pin	670210	N/A	282281 M22520/2-01	282581019	282549049 M81969/1-05	Metal
		Socket	670310	N/A				
22	AWG22 AWG24 AWG26	Pin	670200	M39029/58-360 EN3155-008P2222	282281 M22520/2-01	282562 M22520/2-09	282522 M81969/14-01	Plastic
		Socket	670350	M39029/57-354 EN3155-003S2222				
20	AWG20 AWG22 AWG24	Pin	670220	M39029/58-363 EN3155-008P2020	282291 M22520/1-01	282567 M22520/1-04	282549029 M81969/14-10	Plastic
		Socket	670370	M39029/57-357 EN3155-003S2020				
16	AWG16 AWG18 AWG20	Pin	670230	M39029/58-364 EN3155-008P1616	282291 M22520/1-01	282567 M22520/1-04	282515 M81969/14-03	Plastic
		Socket	670380	M39029/57-358 EN3155-003S1616				
12	AWG12 AWG14 AWG16	Pin	670240	M39029/58-365 EN3155-008P1212	282291 M22520/1-01	282567 M22520/1-04	282549004 M81969/14-04	Plastic
		Socket	670390	M39029/57-359 EN3155-003S1212				

QUADRAX CRIMP CONTACTS

CONTACT SIZE	WIRE SIZE	CLASS	TYPE	RADIALL PART NUMBER	EXTRACTION TOOL	TYPE OF TOOL
8	NF24Q100	Environmental	Pin	670175012	282549001 M81969/28-03 or M81969/14-06	Metal
			Socket	670075012		
	NF26Q100	Environmental	Socket	670075029		
		Non-Environmental	Socket	670075028		
	ABS1503KD24	Environmental	Pin	670175023		
			Socket	670075023		

COAXIAL CRIMP CONTACTS

CONTACT SIZE	WIRE SIZE	CLASS	TYPE	RADIALL PART NUMBER	EXTRACTION TOOL	TYPE OF TOOL
8	EN4604-010 (KX)	Non-Environmental	Pin	670101007	282549001 M81969/28-03 or M81969/14-06	Metal
			Socket	670001007		

QuickFusio is also compatible with coaxial contacts EN3155-067 and EN3155-068.

TRIAx CONTACTS

QuickFusio™ is compatible with triax contacts per EN3155-012; EN3155-024; EN3155-013 and EN3155-025.

Contacts

LUXCIS® ARINC 801 FIBER OPTIC CONTACTS

The LuxCis® Arinc 801 product range is a proven and flexible fiber optic interconnect solution that offers high speed communication in the aerospace market and other harsh environments.

OPTICAL PERFORMANCE

	SINGLEMODE UPC	SINGLEMODE APC	MULTIMODE PC
Wave length	1,310-1,550 nm		850-1,300 nm
Insertion loss Mean	- 0.15 dB	- 0.2 dB	- 0.10 dB
Standard deviation	0.1 dB	0.12 dB	0.07 dB
Return loss	> 50 dB	> 65 dB	> 20 dB

Insertion Loss against a reference pathcord: IEC 61300-3-4 Method B, also described in ARINC 805

Return Loss: IEC 61300-3-6, also described in ARINC 805

MECHANICAL AND ENVIRONMENTAL CHARACTERISTICS

TEST	STANDARD	LUXCIS® ARINC 801 IN QUICKFUSIO+ CONNECTOR
Thermal Cycling	SAE AS 13441 Method 1003.1	-55 °C/+125 °C (Cable Dependent)
Temperature Endurance	TIA/EIA 455-11	1,000 h @ 125 °C (Cable Dependent)
Vibration	EN2591-403-Method B-Level G	27.8 grms
Shocks	EN2591-402	50 grms
Durability	TIA/EIA 364-09	500 Cycles
Maintenance Ageing	SAE AS 13441 Method 2002.1	10 Cycles
Cable Retention 1.8 mm Diameter 900 µm Diameter	SAE AS 13441 Method 2009.1	68 N 7 N
Humidity	TIA/EIA 455-5	10 Cycles/24 h - 90% RH - + 25 °C/+65 °C
Salt Spray	SAE AS 13441 Method 1001.1	96 h
Altitude Immersion	TIA/EIA 455-15A	Minimum Pressure Equivalent to an Altitude of 16,764 m (55,000 ft.).

LUXCIS® CONTACT PART NUMBERING SYSTEM

F725

LUXCIS® SERIES _____

FERRULE TYPE _____

- 00: PC ferrule for single-mode fiber
- 03: PC ferrule for 50/125 or 62.5/125 µm multi-mode fiber
- 04: PC ferrule for 100/40 µm multi-mode fiber
- 05: PC ferrule for 200/230 µm multi-mode fiber
- 50: APC ferrule for single-mode fiber

CABLE TYPE AND DIAMETER _____

- 118: 900 µm cable
- 318: 1.2 mm cable with strengthening members, tight structure
- 419: 1.6 to 2.2 mm cable, loose structure
- 519: 1.6 to 2.2 mm cable, tight structure

Notes

Radiall can support you with your cable and harness assemblies.
Please contact your sales representative.



Contacts

Q-MTITAN™ FIBER OPTIC CONTACTS

Q-MTitan™ is a ruggedized High Density optical solution for harsh environments. It brings multifiber capability through a standard #8 Quadrax cavity. With Q-MTitan™ protecting the MT ferrule, customers can take advantage of the parallel optic technology in harsh environments.

OPTICAL PERFORMANCE

	MULTIMODE PC
Wavelength	850-1,300 nm
Insertion Loss	< 0.50 dB
Return Loss	> 20 dB



MECHANICAL AND ENVIRONMENTAL CHARACTERISTICS

The Q-MTitan™ contact has followed a full qualification test file in multipin connectors sharing the same quadrax cavity design with the QuickFusio™. The following data show the main performance of Q-MTitan™. For additional information, please contact your local Radiall representative.

TEST	STANDARD	Q-MTITANTM CONTACTS
Thermal Cycling	EN 2591-6305	-55 °C/+125 °C (Cable Dependent)
Temperature Endurance	EN 2591-6301	1,000 h @ 125 °C (Cable Dependent)
Vibration	TIA/EIA 455-11C	28 g
Mechanical Endurance	EN 2591-406	200 Cycles
Cable Cycling Flexing	EN 2591-609	10 Cycles/3 N
Cable Pulling	EN2591-610	68 N
Damp Heat Cycling	EN 2591-6321	10 Cycles/24 h - 95% RH - + 38 °C/+65 °C

Q-MTitan™ Series F735 Offers:

- High Density of MT ferrule (12 or 24 fibers)
- Compatibility with round and ribbon multi-fiber cables
- Sealing and cable retention functions on round multi-fiber cables
- Convenient inspection and cleaning with efficient tool kits provided
- User friendly solution: insertion and extraction using standard size 8 tool



Q-MTitan™ contacts are available as pre-terminated cable assembly designed and manufactured based on customer specifications, including various fiber management configurations. Please contact your local Radiall representative with your application requirement.

Contacts

ACCESSORIES

ACCESSORIES FOR THREADED OUTPUT SHELLS

The QuickFusio™ series is compatible with a wide range of standard rear accessories.

The threaded output has been designed per MIL-DTL-38999 series III size 11 rear dimensions. QuickFusio plug and receptacle connectors are suitable for use with Mil-DTL-38999 series III type backshells.

When using F4 and Q1 inserts, refer to page 3-13 to 3-15 to check special grommet protrusion.

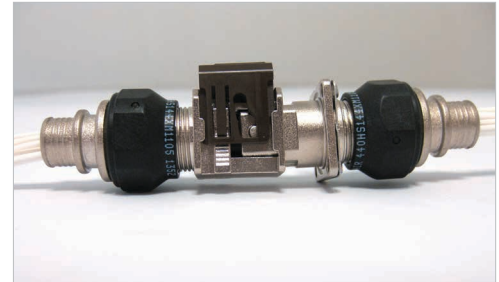

ACCESSORIES FOR BANDING OUTPUT SHELLS

BAND SHIELD TERMINATOR			
Radiall Part Number	Size	Length B	Length C
627990002	Micro	190.5 mm (7.5 in.) - 215.9 mm (8.5 in.)	2.79 mm (0.110 in.) - 2.87 mm (0.113 in.)

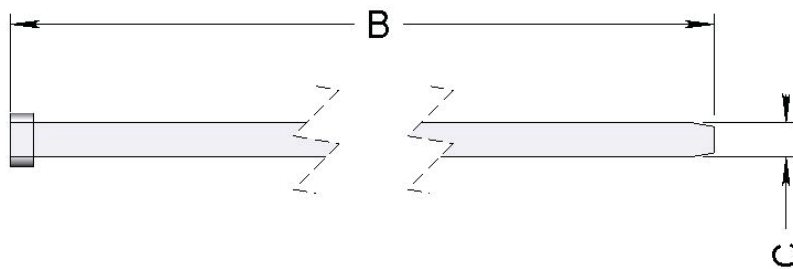

SEALING PLUGS

Sealing plugs are dedicated to environmental inserts.

CONTACT SIZE	RADIALL PART NUMBER	COLOR	STANDARD PART NUMBER
22	616910	Black	MS27488-22-2
20	616911	Red	MS27488-20-2
16	616912	Green	MS27488-16-2
12	616913	Orange	MS27488-12-2
8	618915	Red	N/A

Notes

To be used with banding tool A30199

Contacts

SPARE PARTS & TOOLS

	PART NUMBER	DESCRIPTION
	627954001	Dust Cap for Plug Shell (Pink)
	627954002	Dust Cap for Receptacle Shell (Pink)
	627954003	ESD Dust Cap for Receptacle Shell (Black)
	627954004	ESD Fly Cap for Receptacle Shell (Black)
	627802001	Sleeve Holder for F4 Insert
	282549048	Extraction Tool for Sleeve Holder
	670950013	Sealing Boot for Size 8 Quadrax Contacts Cable: NF 24 Q100 and ABS1503KD24
	627990001	Screw Kit (4 x UNC 4-40 3A 5/16 Screws and 4 x Washers)
	282690050	Flat Screwdriver for Slide Lock Opening FACOM_AN_2.5 x 50
	627900001	Bundle Mount Platform
	282690051	Holding Wrench for Rear Threaded Accessory

Notes