



**Switching Connectors / Moebius
MC-Card / RP-MCX**

R199 / R299



Contents

Introduction 5-4 to 5-5

MOEBIUS

Characteristics 5-6

Receptacles 5-7

Switching connectors 5-7

Plugs 5-8

Adapters 5-8

PCB pattern 5-8

MC-CARD

Characteristics 5-9

Plugs 5-10

SMT Receptacle 5-10

SMT Switches 5-11

Adapters 5-11

Assembly instructions 5-12

PCB pattern 5-12

RP-MCX

Interface 5-13

SMT Switches 5-13

RF POWER SWITCHING CONNECTORS

QMA Type 5-14

N Type 5-15

SMA Type 5-14

QN Type 5-15

TNC Type 5-14

Introduction

Radiall offers a complete range of switching connectors that consists of four families:

- Microminiature, Moebius, for high life cycle mobile applications
- Microminiature, MC-Card, for mobile applications
- Reverse polarity MCX
- Power, for infrastructure applications



Microminiature Moebius: Designed for life

We chose Moebius in reference to the Möbius strip, as the origin of the infinity symbol. It is a good illustration for the very high durability performance of the Moebius connector. The Moebius interface is designed to be used as an antenna connection for handheld and mobile computing devices. The switching connector provides high RF performance and it is extremely durable and reliable as a snap-on connection.

Microminiature MC-Card

The MC-Card series are micro miniature, 50Ω connectors that feature snap-on mating and a frequency range of –8 GHz. The MC-Card series was designed by Radiall in the 90s. With the success of the switching version, it made the MC-Card an excellent alternative to MMCX connectors for numerous wireless and telecom applications. In addition, the MC-Card series offers similar performance as the MMCX by featuring quick snap-on mating and unmating withstanding a minimum of 5,000 mating cycles.

The globally adopted switching connector version consists of a female edge card receptacle with an integrated switch for SMT assembly. It allows for automatic switching between two RF signal paths. This connector is mainly used for wireless PCMCIA-Cards or GPS devices to switch between the internal antenna and a higher-gain external antenna.

In addition to the standard MC-Card series, Radiall also offers a 3mm dia. MC-Card. With this version, wireless equipment can be differentiated and protected against wrong antenna connections.



Introduction

Reverse Polarity MCX

This switching connector is available in straight SMT version and can be placed anywhere on the PCB. Reverse polarity MCX connectors must be used to activate the switch function. It is not compatible with standard MCX.

Power switching connectors

RF power switching connectors are surface/edge mountable. It's a two in one solution replacing the existing standard RF switches by integrating the switch function into a connector. This solution provides a unique means of switching between two RF signal paths. The switch is mechanically activated by mating and unmating the connector.

MAIN ADVANTAGES

- Reliable
- Increases the density
- Excellent electrical and mechanical performance
- Cost savings
- Available in a right or left version
- Many interfaces available: N, TNC, SMA, QN, QMA and more

MAIN APPLICATIONS

- Telecom base station equipment
- RF power amplifiers

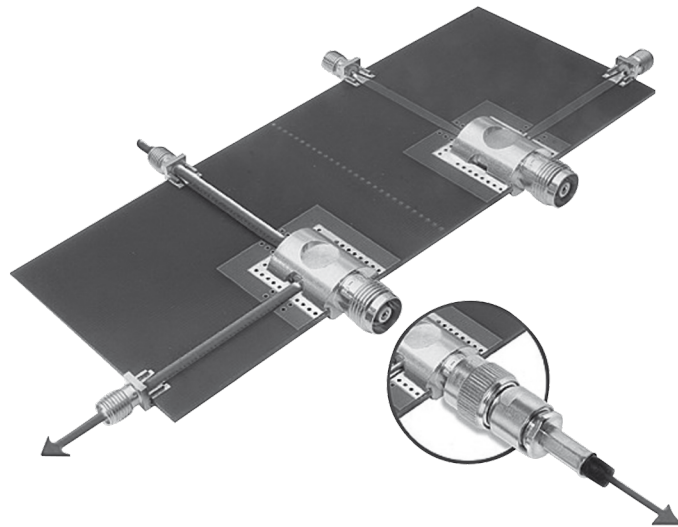

Characteristics

	Not mated	Mated
Operating temperature range	-40°C to + 110°C	
Rated power	10 W / 900 MHz	
DC Current Withstanding	1 A max	
Frequency range	DC to 6 GHz	
V.S.W.R.	1.20 max DC to 3 GHz 1.50 max 3 to 6 GHz	1.15 max DC to 3 GHz 1.25 max 3 GHz to 6 GHz
Insertion loss	0.15 dB max DC to 2 GHz 0.20 dB max 2 GHz to 3 GHz 0.40 dB max 3 GHz to 6 GHz	0.10 dB max DC to 2 GHz 0.15 dB max 2 GHz to 3 GHz 0.20 dB max 3 GHz to 6 GHz
Isolation loss	- - -	35 dB minDC to 1 GHz 25 dB min 1 GHz to 3 GHz 25 dB min 3 GHz to 6 GHz

Item	Specification	Conditions
Contact resistance	200 mΩ max	100 mA
Insulation resistance	3000 MΩ min	250 V DC
Withstanding voltage	No flashover or insulation breakdown	250 V rms
Vibration	No discontinuities > 1µs under 100mA	Sinus: 5-500Hz / displacement 0.75 peak / acceleration 10 g duration 2h in each direction Random: 5-1000Hz / displacement 0.75 peak / acceleration 3.3 g duration 1h in each direction 25 dB min 3 GHz to 6 GHz
Shock	No discontinuities > 1µs under 100mA	Acceleration 50 g / duration pulse 11 ms / waveform pulse half sinus / number of shocks 3 per direction
Free fall	Center contact resistance RF measurements No discontinuities > 1 ms under 100mA	NFC 20732 method 1 Test area concrete / fall height 1 m / duration 2*2 falls
Temperature life	Center contact resistance RF measurements	T + 90°C / duration 1000 h / 40% HR
Thermal shock	Center contact resistance RF measurements	T - 40°C to + 90°C Exposure 15mn / transfert time < 10 s / 100 cycles
Damp heat	Center contact resistance RF measurements	40°C / 93% / 21 days
Retention Force • Insertion Force - mating • Extraction Force - unmating	9N 12N	Initial
Durability	Mating - unmating force Center contact resistance RF measurements	25.000 cycles

MATERIALS AND PLATING

	Material	Plating
Body	Brass	NPGR
Center contact		
Outer contact		
Insulator	PTFE / nc	
Others parts	Beryllium copper	NPGR

Receptacle and switching connector

RECEPTACLE

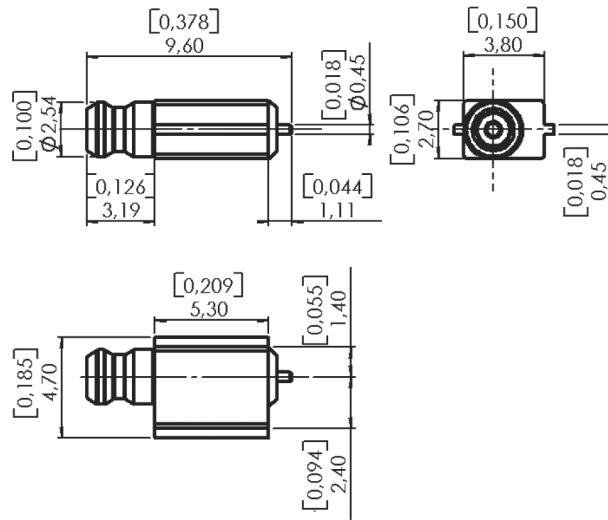
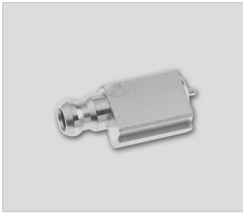

Part number	Packaging	RoHS
R199 006 413	100 pieces/reel	yes

SWITCHING CONNECTOR

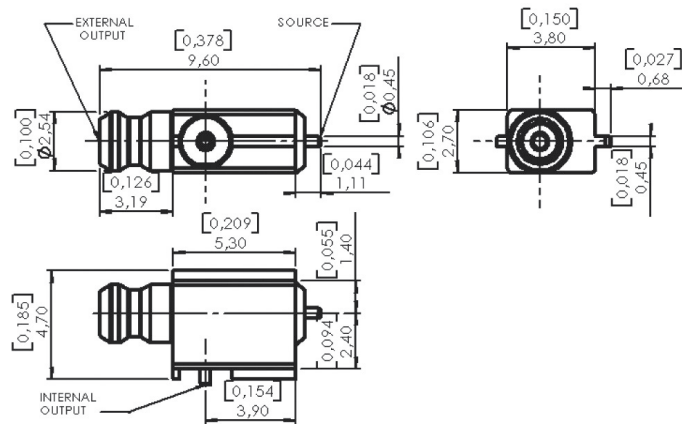

Part number	Packaging	RoHS
R199 006 813	100 pieces/reel	yes



Plugs, adapter and PCB pattern

STRAIGHT AND RIGHT ANGLE PLUGS

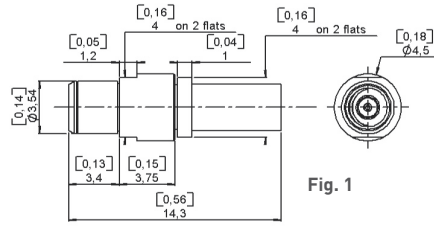
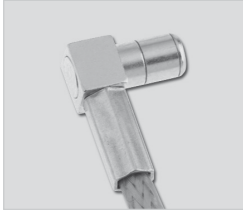

Fig. 1

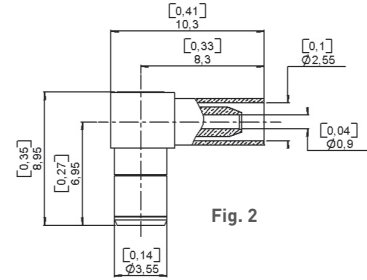

Fig. 2

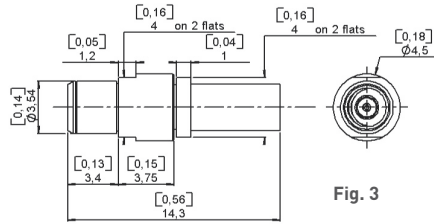

Fig. 3

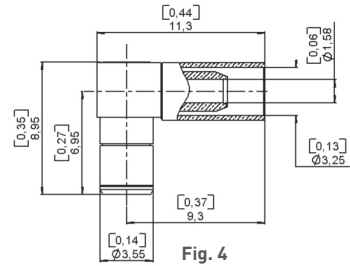
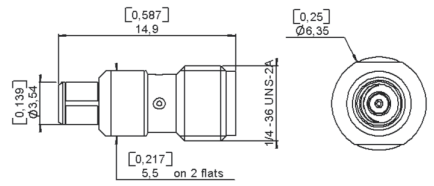

Fig. 4

Cable group	Cable group dia.	Part number	Fig.	Packaging	RoHS
RG178 / RG196	2/50/S	R199 006 203	1	100/Box	yes
		R199 006 213	2		
RG174 / RG316	2.6/50/S	R199 006 263	3		
		R199 006 273	4		

SMA ADAPTER



Part number	Packaging	RoHS
R191 857 000	Unit	yes

PCB pattern

P01

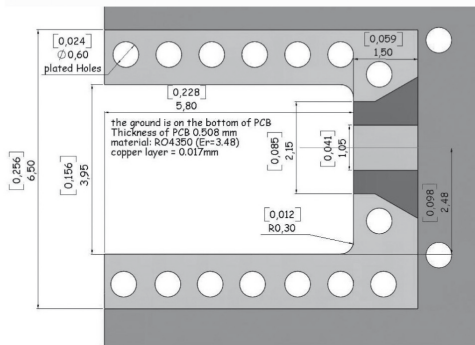

Receptacles

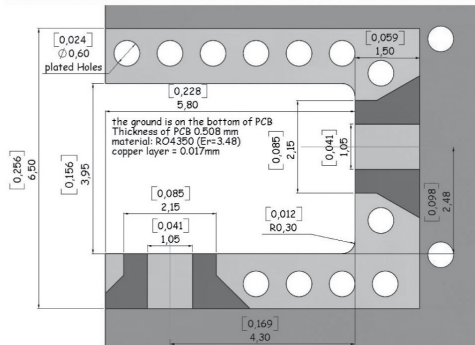

Switching Connectors

Characteristics

Test / Characteristics	Values / Remarks
------------------------	------------------

ELECTRICAL CHARACTERISTICS

Impedance	50Ω				
Frequency range	Connectors: DC - 8 GHz Switch: DC - 3 GHz				
Typical V.S.W.R. • Straight models - 2/50 cable • Right angle models - 2/50 cable - 2.6/50 cable	1	2.5	4	6	8
	1.07	1.15	1.16	1.17	1.25
	1.08 1.05	1.17 1.08	1.22 1.10	1.26 1.13	1.30 1.12
Insertion loss (dB) • Straight connectors • Right angle connectors	0.04	0.08	0.11	0.15	0.15
	0.05	0.10	0.15	0.20	0.25
RF leakage (dB max)	-65 dB max at 8 GHz				
Insulation resistance	5000 MΩ min				
Contact resistance • Center contact • Outer contact	1.5 mΩ				
	0.2 mΩ				
Working voltage in V.R.M.S. • At sea level (at 21000 m)	170				
Dielectric withstanding voltage in V.R.M.S. • At sea level	500				
RF testing voltage sea level in V.R.M.S.	500				

MECHANICAL CHARACTERISTICS

Durability	5000 matings
Force to engage and disengage	6.2 N
Force to disengage	8.8 N
Cable retention force • 2/50 cable • 2.6/50 cable	58 N
	110 N
Center contact retention force	slide-on

ENVIRONMENTAL CHARACTERISTICS

Temperature range • Switches • Others	-40°C / +110°C
	-25°C / +125°C
Thermal cycling test	MIL STD 202, method 107, condition B
High temperature endurance	MIL STD 202, method 108
Corrosion (salt spray)	MIL STD 202, method 101, condition B
Vibration	MIL STD 202, method 204, condition B
Shock	MIL STD 202, method 213, condition G
Moisture resistance	MIL STD 202, method 106
Hermeticity	MIL STD 202, method 112, condition C
	Vacuum 10 ⁻⁶ Hgmm (Torr)
	Leakage rate 10 ⁻⁶ atm / cm ³ / s
Barometric pressure	Pressure test: 3.5 bars; duration: 2 mn; Temperature: 15°C to 25 °C

MATERIALS

Bodies	Brass
Center contact • Male • Female	Brass
	Bronze or heat treated Beryllium following QQ-C-530
Insulator • Cable connectors • Switches	PTFE
	Polyether ethercetone 30% GF
Gasket	Silicon rubber

PLATING

Bodies • Cable connectors • SMT receptacles • Edge card receptacles • Switches	Nickel or BBR
	Gold
	Gold
	Gold
	Gold
Center contacts	Gold

Plugs and SMT receptacle

STRAIGHT PLUGS

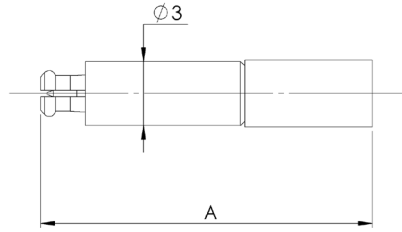

Cable group	Cable group dia.	Part number	Dimensions A (mm)	Captive center contact	Finish	Note
RG178 / RG196	2/50/S	R199 005 200	15.6	no	Nickel	Crimp type
RG405	.085"	R199 005 223	10.1	yes	Gold	Solder type

RIGHT ANGLE PLUGS

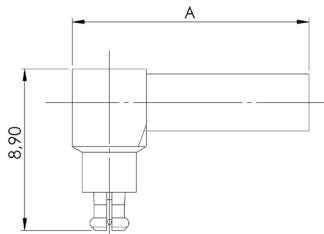

Cable group	Cable group dia.	Part number	Dimensions A (mm)	Captive center contact	Finish	Note
-	1/50/S	R199 005 310*	9.1	yes	Gold	MC-CARD 3mm dia.
RG178 / RG196	2/50/S	R199 005 240	13.1		Nickel	Crimp type
RG174 / RG316	2.6/50/S	R199 005 250	7.8		Gold	Solder type
RG405	.085"	R199 005 273				

*Specific 3 mm interface = not compatible with standard interface plug

SMT RECEPTACLE

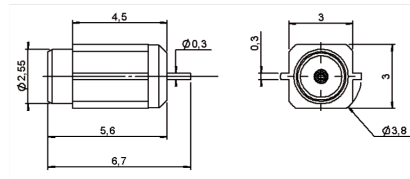

Fig. 1

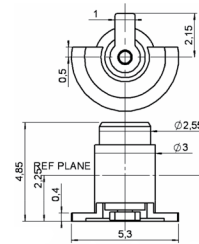

Fig. 2

Part number	Fig.	Captive center contact	Assembly instructions	PCB pattern	Finish	Packaging
R199 005 800	1	yes	M01	P02	Gold	400 pieces/reel
R199 005 820	2					100 piece/reel

SMT Switches and adapters

SMT SWITCHES

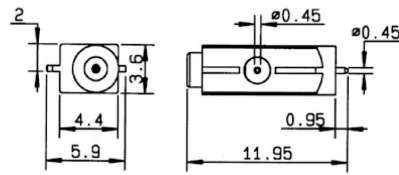

Fig. 1

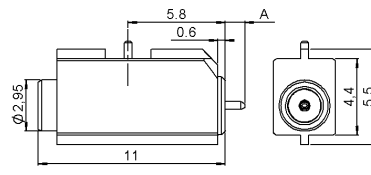

Fig. 2

Part number	Fig	Dimension A (mm)	Captive center contact	Assembly instructions	PCB pattern	Finish	Packaging	Note
R199 005 890	1		yes	M01	P01	Gold	500 pieces/reel	
R299 794 800*	2	0.93						MC-CARD 3mm dia.

*Specific 3 mm interface = not compatible with standard interface plug

Electrical diagram on "M01"

BETWEEN SERIES ADAPTERS

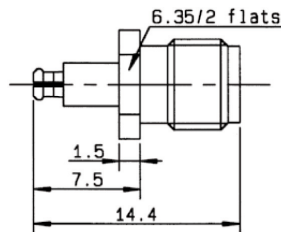

Fig. 1

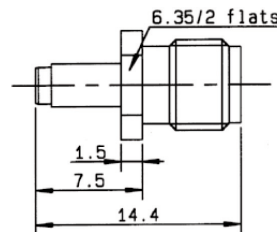
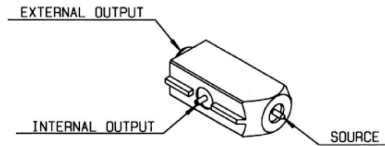

Fig. 2

Part number	Fig.	Series	Body and finish
R191 366 071	1	SMA female / MC CARD male	Passivated stainless steel
R191 366 091	2	SMA female / MC CARD female	

Assembly instructions

M01 ELECTRICAL DIAGRAM



Part number	Step 1	Step 2
R199 005 890 R299 794 800	<p>UNMATED CONNECTOR</p>	<p>MATED WITH MC CARD PLUG</p>

VIDEO SHADOW AND ASPIRATION AREA

Part number	Video shadow of receptacle	Aspiration area
R199 005 800		
R199 005 890 R299 794 800		

*2.95 for: R299 795 830 - R299 794 800

PCB pattern

P01

Part number

R199 005 890
R299 794 800

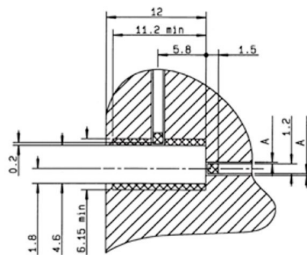

▨ Pattern
▣ Land for solder paste

P02

Part number

R199 005 800

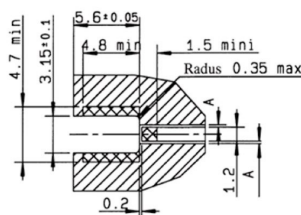

PCB thickness (mm)	Coplanar line A (mm)
0.8	0.183
1.0	0.190
1.2	0.195
1.6	0.200

Interface

PLUG

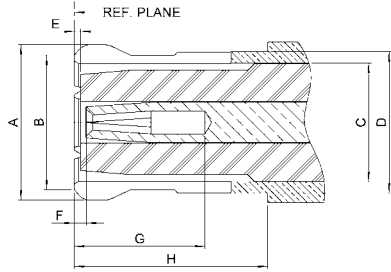

JACK

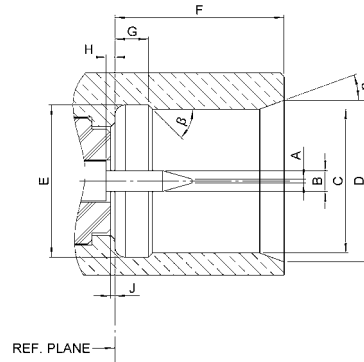

Letter	mm		inch	
	min.	max.	min.	max.
A DIA		3.80		.150
B DIA		3.60		.142
C DIA		3.00		.118
D DIA		3.40		.134
E	0		0	.004
F	0		0	.008
G	2.60		.110	
H	4.15		.163	

Letter	mm		inch	
	min.	max.	min.	max.
A DIA	3.15	3.20	.124	.126
B DIA	2.74	2.84	.108	.112
C DIA	0.52	0.60	.0205	.0235
D DIA	0		0	
E DIA	1.14	1.40	.045	.055
F	0.36	0.41	.014	.016
G	3.53	3.68	.139	.145
H			0	
J			0	
a	18°	22°	18°	22°
b	43°	47°	43°	47°

SMT switches

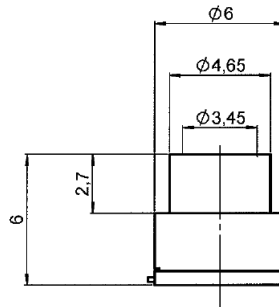
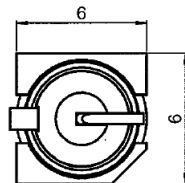

Part number	Finish	Packaging
R299 137 800	Gold	Tape & Reel 200 pieces
R299 137 801		Tape & Reel 900 pieces

RF power switching connectors

Test / Characteristics	Values / Remarks				
------------------------	------------------	--	--	--	--

ELECTRICAL CHARACTERISTICS

	QMA	QN	SMA	N	TNC
Impedance	50Ω				
Frequency range	DC - 3 GHz				
Typical V.S.W.R.	1.1 + 0.1000 x F (GHz) Maxi	1.1 + 0.1000 x F (GHz) Maxi	1.1 + 0.1000 x F (GHz) Maxi	1.1 + 0.1000 x F (GHz) Maxi	
Isolation at <ul style="list-style-type: none"> • DC to 1 GHz • 1 to 2 GHz • 2 to 3 GHz 	- 47 dB typical - 43 dB typical - 40 dB typical				
Insertion Loss at <ul style="list-style-type: none"> • DC to 1 GHz • 1 to 2 GHz • 2 to 3 GHz 	- 0.1 dB maxi - 0.15 dB maxi - 0.2 dB maxi				
RF leakage	NA	NA	NA	NA	
Voltage rating	300 Veff maxi				
Dielectric withstanding voltage	500 Veff mini				
Insulation resistance	5000 MΩ mini				
Power withstanding	110 W (at 2 GHz)	110 W (at 2 GHz)	50 W (at 1.8 GHz)	100 W (at 1.8 GHz)	50 W (at 1.9 GHz)

QMA TYPE

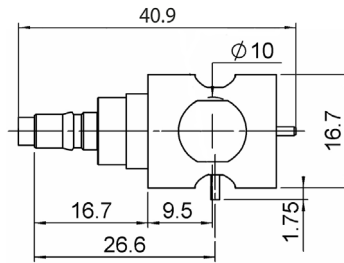

Part number	Type
R123 422 801	Right

SMA TYPE

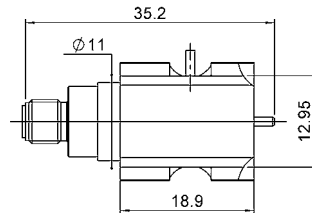

Part number	Type
R124 422 001	Right

TNC TYPE

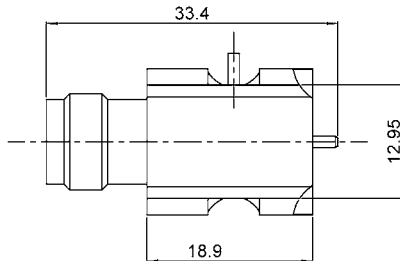

Part number	Type
R143 422 947	Left
R143 422 957	Right

RF power switching connectors

Test / Characteristics	Values / Remarks
------------------------	------------------

N TYPE

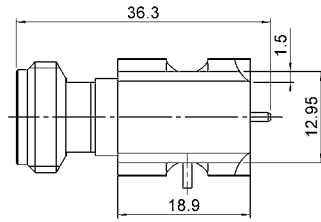

Part number	Type
R161 428 223	Left
R161 428 233	Right

QN TYPE

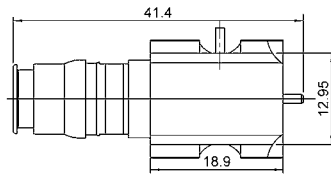

Part number	Type
R164 428 823	Left
R164 428 833	Right

RF POWER SWITCHING CONNECTORS