



**High Voltage Connectors
(BNC HT-MHV / SHV / THT 20 / HN)
Non-Magnetic Connectors**

R316 / R317 / R331 / R176



Contents

HN	
Introduction	15-4
Interface	15-4
Characteristics	15-4
Plugs	15-5
Jacks	15-5
Receptacles	15-5
Adapters	15-6
Caps	15-6
Panel drilling	15-6
HIGH VOLTAGE	
Introduction.....	15-7 to 15-8
BNC HT/MHV	
Characteristics	15-7 to 15-8
Plugs	15-9
Jacks	15-9
Receptacles	15-9
Adapters	15-10
Gasket	15-10
SHV	
Characteristics	15-11
Plugs	15-12
Jacks	15-12
Receptacles	15-13
Adapter	15-13
THT 20	
Characteristics	15-14
Plugs	15-14
Receptacles	15-15
Panel drilling	15-15
NON-MAGNETIC MCX	
Introduction.....	15-16 to 15-19
MMCX Plugs	15-20 to 15-21
Plugs	15-20
Jacks	15-21
Receptacles.....	15-21
NON-MAGNETIC SMP	
Plugs	15-21 to 15-22
Receptacles.....	15-23
NON-MAGNETIC SMB AND BNC	
Plugs	15-21 to 15-22
Jacks	15-22
Receptacles.....	15-23
NON-MAGNETIC CABLE TERMINALS	
Right angle terminal	15-24
Straight terminal	15-23
NON-MAGNETIC CABLE ASSEMBLIES	
Non-magnetic cable assemblies.....	15-25
Panel drilling	15-25

Introduction

The HN series is designed for industries needing accuracy in RF and HV applications up to 5000 Volts. Radiall continuously strives to improve the range of HN coaxial connectors for nuclear and harsh environments. Our customized connectors allow high radiation resistance, and by using a hexagonal nut for mating, they provide a secure connection. Please contact Radiall regarding this dedicated nuclear range.

Interface

PLUG

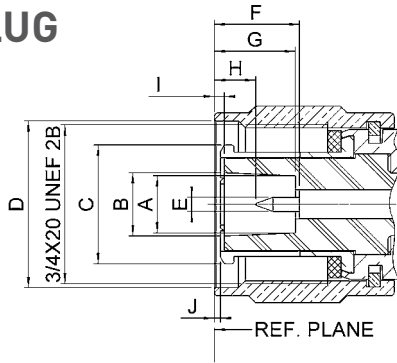

JACK

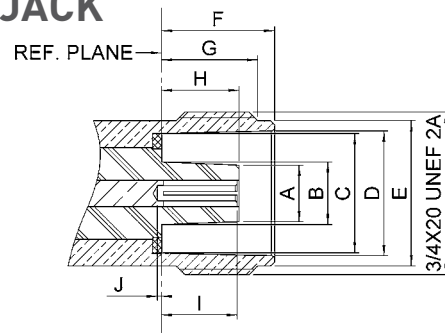

Letter	mm		inch	
	min.	max.	min.	max.
A DIA	6.7	6.8	.264	.268
B DIA	7.4	7.5	.291	.295
C DIA	13.85	13.95	.545	.549
D DIA	19.39	19.59	.763	.771
E DIA	1.62	1.66	.064	.065
F	9.3	10.1	.366	.398
G	9.2	9.7	.362	.382
H	3.9	5.3	.154	.209
I	0.15	0.55	.006	.022
J	-0.5	0.3	.020	.012

Letter	mm		inch	
	min.	max.	min.	max.
A DIA	6.55	6.65	.258	.262
B DIA	7.25	7.35	.285	.289
C DIA	13.91	14.01	.548	.552
D DIA	14.54	14.64	.572	.576
E DIA	16.91	17.01	.666	.670
F	13.2	13.25	.520	.522
G	11.1	11.35	.437	.447
H	8.75	9.25	.344	.364
I	8.55	9.15	.337	.360
J	-1.05	0.15	-.041	.006

Characteristics

ELECTRICAL CHARACTERISTICS

Frequency range	DC to 3 GHz
Impedance	50 Ω
Test voltage at sea level	5000 Vrms (except connector for 5/50-6/75 cable group & adapter M-F: 3000 Vrms)
Insulation resistance	5000 MΩ

MECHANICAL CHARACTERISTICS

Mechanical endurance	500 matings
Vibration	20 g
Shock	1/2 sinusoidal (severity 100 A)

ENVIRONMENTAL

Temperature range	-55°C + 155°C
Salt spray	48 Hrs
Panel sealing	Splashproof

MATERIALS

Contacts and interfaces	Heat treated beryllium copper
Other pieces	Brass / Stainless steel
Insulator	PTFE / Ceramic / PEEK
Gasket	Silicone rubber

PACKAGING

Packaging	Unit
-----------	------

Plugs, jack and receptacle

STRAIGHT PLUGS CLAMP TYPE

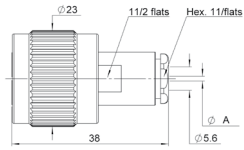

Fig. 1

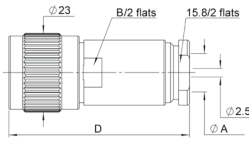

Fig. 2

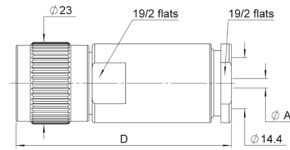

Fig. 3



Cable group	Cable group dia.	Part number	Fig.	Dimensions mm		
				A	B	D
RG58 / RG141 / RG142 / RG223 / RG400	5/50/S+D	R176 006 000	1	5.6		
RG59 / RG62	6/75/S+93	R176 012 000		6.5		
RG213 / RG393 / RG214	10+11/50/S+D	R176 018 000	2	11.2	17	49
		R176 019 000			15.8	56.5
		R176 021 000			17	53
RG 217	14/50	R176 027 000	3	2.5		63

STRAIGHT JACK CLAMP TYPE

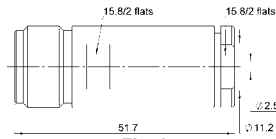

Fig. 1

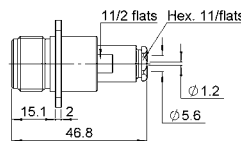
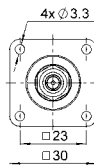

Fig. 2

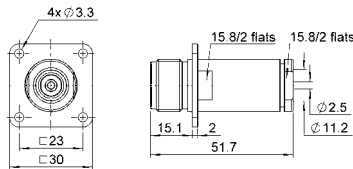
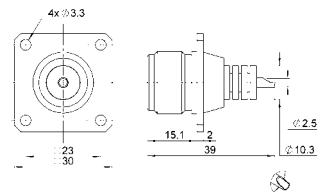

Fig. 3

Cable group	Cable group dia.	Part number	Fig.	Panel drilling	Note
RG213 / RG393 / RG214	10+11/50	R176 218 000	1		
RG58 / RG141 / RG142 / RG223 / RG400	5/50/S+D	R176 256 000	2	P02	Square flange
RG213 / RG393 / RG214	10+11/50	R176 268 000	3		

FLANGE RECEPTACLE



Part number	Panel drilling	Note
R176 404 000	P02	Square flange - Solder pot

Adapters and caps

IN SERIES ADAPTERS

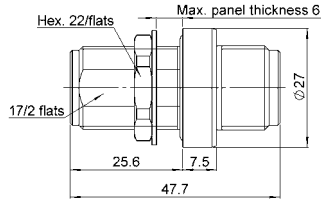

Fig. 1

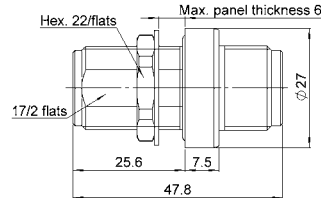

Fig. 2

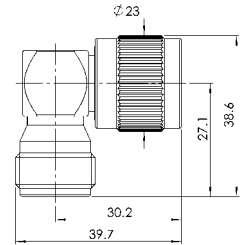

Fig. 3

Part number	Fig.	Panel drilling	Note
R176 754 000	1	P01	Bulkhead female-female - Splashproof panel seal
R176 754 150	2		Bulkhead female-female - Splashproof panel seal - Ceramic insulator
R176 770 000	3		Right angle - male-female

CAPS

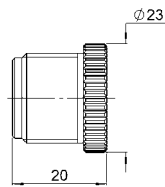

Fig. 1

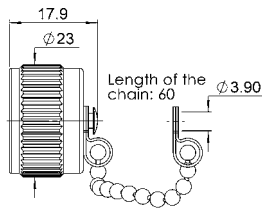
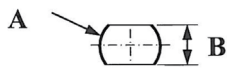

Fig. 2

Part number	Fig.	Note
R176 830 010	1	Protective cap
R176 811 000	2	Protective cap with chain

Panel drilling

PO1



	mm	
	Maxi	mini
A	19.3	19.2
B	17.3	17.2

PO2

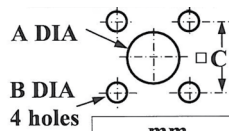

	mm	
	Maxi	mini
A	19.5	19.4
B	3.5	3.4
C	23.1	23

Introduction

This catalogue features 4 series of high voltage coaxial connectors - all able to withstand continuous voltage up to 20 000 V.

By redesigning the BNC HT interface in order to benefit from its high performance to serve MHV, Radiall created BNC HT/MHV. Radiall BNC HT/MHV is fully compatible with BNC HT with MHV interface according to MIL-STD-348.

TEST VOLTAGES

The test voltages quoted in this catalogue are indicative only. They correspond to those made under normal atmospheric conditions during a test period of 1 minute as specified in the French standard NF EN 60068 - 1.

OPERATING VOLTAGES

The operating voltage is chosen under the responsibility of users, depending on the conditions in which the connectors will be used (environment, safety factor...). The indicated cables are recommended for the mechanical and dimensional suitability with our connectors. As to the electrical characteristics of the cables and in particularly the maximum voltage capacity, it is necessary to conform with the recommendation of the cable manufacturer.

Characteristics BNC HT/MHV

BNC HT/MHV connectors are not intermateable with the BNC and SHV series.

ELECTRICAL CHARACTERISTICS

Frequency range	DC - 2 GHz
Impedance	50Ω
VSWR (plug and jack)	1.20 + 0.2 F (GHz)
Test voltage <ul style="list-style-type: none"> • Unmated (Male) • Connectors (Female) • Mated pair 	6 000 V D.C.
	6 000 V D.C.
	10 000 V D.C.
Current rating	10 A

MECHANICAL AND ENVIRONMENTAL CHARACTERISTICS

Mating cycles	500
Vibration	20 g - 2 000 Hz
Shock	50 g
Salt spray	48 H
Temperature range	- 55°C + 155°C - 40°C + 70°C (with polyethylene insulator)

MATERIALS AND PLATING

Components	Materials	Platings
Body	Brass	Nickel
Center contact	Brass / Beryllium copper	Silver
Other metal parts	Brass or Beryllium copper	Nickel
Insulator	PTFE / Polyethylene	
Gasket	Silicone rubber	

All dimensions are given in mm.

Plugs, jacks and receptacles

STRAIGHT PLUGS FOR FLEXIBLE CABLES

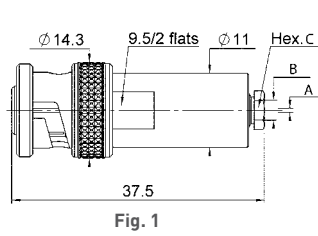

Fig. 1

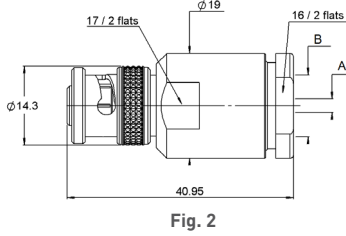

Fig. 2

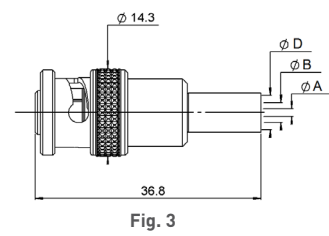

Fig. 3

Cable group	Cable group dia.	Part number	Fig.	Dimensions				Note
				A dia.	B dia.	Hex. C	D dia.	
RG174 / RG316 / RD316 / RG179 / RD179	2.6/50+75/S + D	R316 004 000	1	0.6	3	5/flats	-	Clamp type
RG58 / RG141 / RG142 / RG223 / RG400	5/50/S + D	R316 007 000		1.2	5.6	9.5/flats	-	
RG59/RG62	6/75/S	R316 011 000	3	1.2	6.5	9.5/flats	-	Crimp type
RG58/RG141	5/50/S	R316 072 000		1.2	3.2	-	5.6	
RG214 / RG393 / RG213	10/50/S+D	R316 020 010	2	2.5	11.2	-	-	Clamp type
RG59 / RG62	6/75/S	R316 072 010	3	1.2	4	-	6.6	

STRAIGHT JACKS CLAMP TYPE FOR FLEXIBLE CABLES

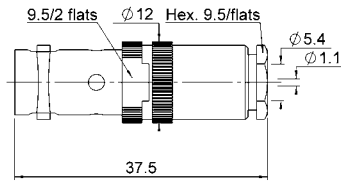

Fig. 1

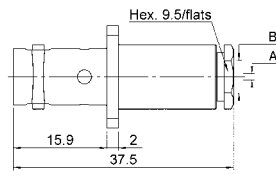

Fig. 2

Cable group	Cable group dia.	Part number	Fig.	Dimensions			Panel Drilling
				A	B	C	
RG58 / RG141 / RG142 / RG223 / RG400	5/50/S + D	R316 207 000	1	1.1	5.4	37.5	
RG59 / RG62	6/75S	R316 211 000			6.5	38.5	
RG58 / RG141 / RG142 / RG223 / RG400	5/50/S+D	R316 257 000	2	1.1	5.4	37.5	P01
RG59 / RG62	6/75/S	R316 261 000			6.5		

Receptacles, adapters and gasket

RECEPTACLES

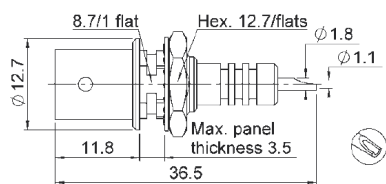

Fig. 1

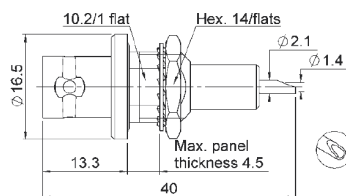

Fig. 2

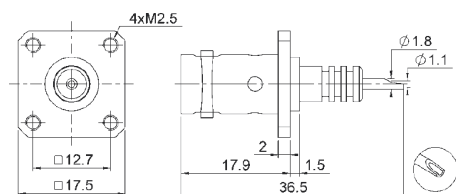

Fig. 3

Part number	Fig.	Panel Drilling	Note
R316 553 000	1	P02	Bulkhead
R316 603 000	2	P03	Bulkhead panel seal
R316 405 000	3	P01	Square flange mounting

IN SERIES ADAPTERS

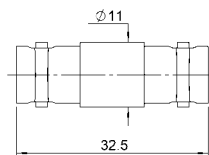

Fig. 1

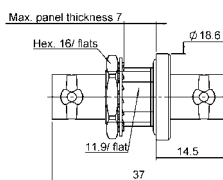
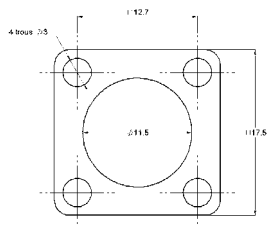

Fig. 2

Part number	Fig.	Panel Drilling	Note
R316 704 000	1		Straight female - female
R316 754 000	2	P04	Straight bulkhead female - female with panel seal

GASKET



Part number
R280 503 000

Introduction

These safe high voltage connectors meet all requirements of the NIM Standard (Nuclear Instrumentation Module) Specification ND 545 Amendment A. Both the pin and socket contacts are securely recessed inside the insulation to guard against potential electrical shock when live unmated connectors are handled.

They are particularly recommended for impulse circuits of linear accelerators as well as in military, nuclear and medical electronics.

These connectors are not intermateable with the BNC and BNC HT/MHV series.

Characteristics

ELECTRICAL CHARACTERISTICS

Frequency range		DC - 2 GHz
Impedance		50Ω
VSWR (plug and jack)		< 1.20 + 0.3 F (GHz)
Contact resistance	• Center contact	< 2.1 mΩ
	• Outer contact	< 1.5 mΩ
Test voltage	• Unmated connectors	10 000 V D.C.
	• Mated pair	12 000 V D.C.
Current rating		10 A

MECHANICAL AND ENVIRONMENTAL CHARACTERISTICS

Temperature range		- 65°C + 165°C
Mating cycles		500
Vibration		10 g - 500 Hz to MIL-STD-202, method 204, condition A
Shock		To MIL-STD-202, method 213 B, condition A
Salt spray		To MIL-STD-202, method 101, condition B-48 H
Contact to cable retention force		> 27 N
Coupling nut retention force		> 450 N
Cable retention		> 180 N

MATERIALS AND PLATING

Components	Materials	Plating
Body	Brass	Nickel
Center contact	Brass / Beryllium copper	Gold
Other metal part	Brass / Beryllium copper	Nickel
Insulator	PTFE	
Gasket	Silicone rubber	

Plugs

STRAIGHT PLUGS FOR FLEXIBLE CABLES

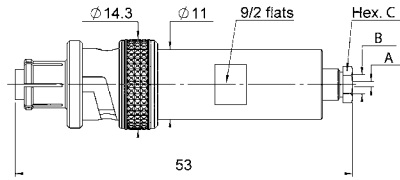

Fig. 1

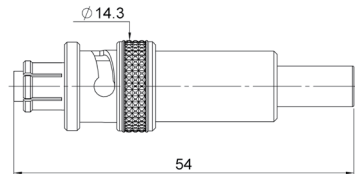

Fig. 2

Cable group	Cable group dia.	Part number	Fig.	Dimensions			Captive center contact	Note
				A dia.	B dia.	Hex. C		
RG58 / RG141 / RG142 RG223 / RG400	5/50/S + D	R317 005 000	1	1.05	5.6	9.5/flats	yes	Clamp type
RG58 / RG141 RG59 / RG62	5/50/S 6/75/S	R317 072 000 R317 074 000	2					Crimp type

All dimensions are given in mm.

Jacks

STRAIGHT JACKS FOR FLEXIBLE CABLES

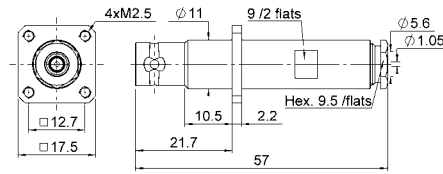

Fig. 1

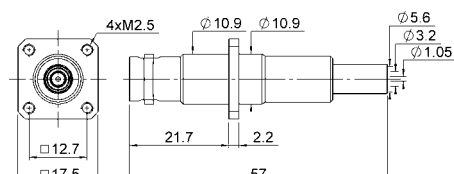

Fig. 2

Cable group	Cable group dia.	Part number	Fig.	Panel Drilling	Captive center contact	Note
RG58 / RG141 / RG142 RG223 / RG400	5/50/S + D	R317 255 000	1	P01	yes	Square flange clamp type
RG58 / RG141	5/50/S	R317 270 000	2		Square flange crimp type	

Receptacles and in series adapter

SHV

RECEPTACLES

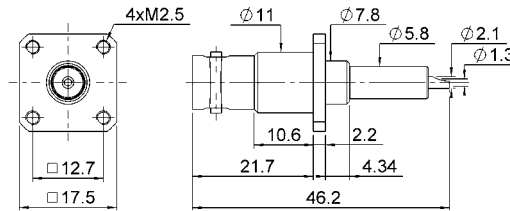

Fig. 1

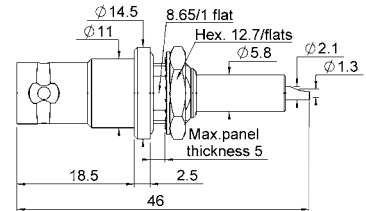
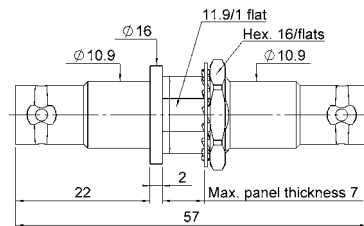

Fig. 2

Part number	Fig.	Panel Drilling	Note
R317 405 000	1	P05	Square flange
R317 580 000	2	P06	Bulkhead

IN SERIES ADAPTER



Part number	Panel Drilling	Note
R317 720 000	P04	Bulkhead jack - jack

Introduction

This large size screw-on interface has a 4 mm internal diameter female center contact which allows testing with standard banana plugs. THT 20 features the highest test voltage with a rating of 20 000 VDC for a mated pair.

Characteristics

Female center contact has a 4 mm internal diameter which allows testing with standard banana plugs.

- Screw coupling

ELECTRICAL CHARACTERISTICS

Frequency range		DC - 1 GHz
Impedance		50Ω
Test Voltage	• Unmated connectors	10 000 V D.C.
	• Mated pair	20 000 V D.C.
Current rating		20 A

MECHANICAL AND ENVIRONMENTAL CHARACTERISTICS

Temperature range	- 40°C + 70°C (polyethylene or styramic insulators) -55°C + 125°C (PTFE insulator)
Mating cycles	500
Salt spray	48 H

MATERIALS AND PLATING

Components	Materials	Plating
Body	Brass	Nickel
Center contact	Brass / Beryllium copper	Gold / Silver
Other metal part	Brass	Nickel
Insulator	PTFE / Polyethylene	
Gasket	Silicone rubber	

Plugs

STRAIGHT PLUGS, CLAMP TYPE FOR FLEXIBLE CABLES

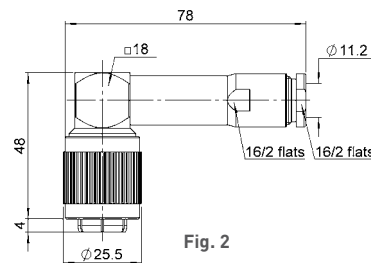
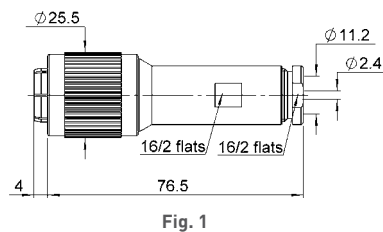

Cable group	Cable group dia.	Part number	Fig.	Note
RG213 / RG393 / RG214	10/50+75/S + D + 11/50+75/D	R331 018 000	1	Straight / PE insulator
RG11 / RG12 / RG144 / RG216		R331 168 000	2	Right angle

Receptacles

RECEPTACLES

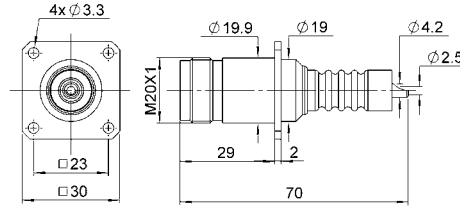

Fig. 1

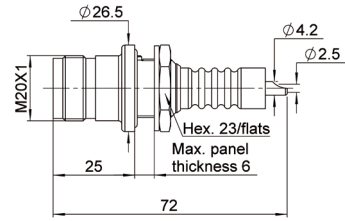
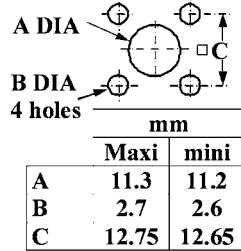

Fig. 2

Part number	Fig.	Panel drilling	Note
R331 405 000	1	P07	Square flange - PTFE insulator
R331 603 000	2	P08	Bulkhead, panel seal PTFE insulator

Panel drilling

P01



P02

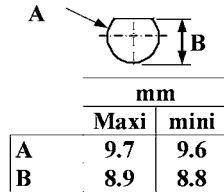

P03

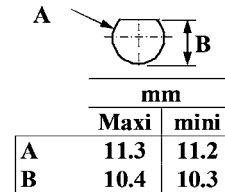

P04

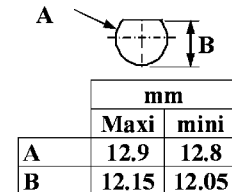

P05

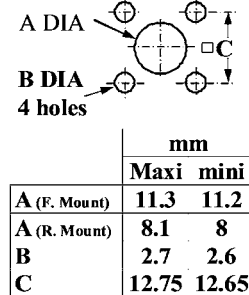

P06

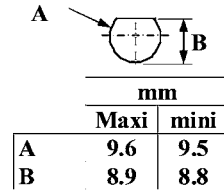

P07

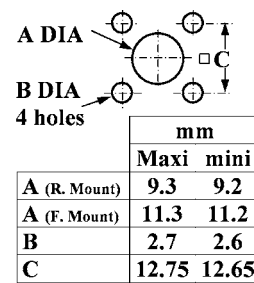

P08

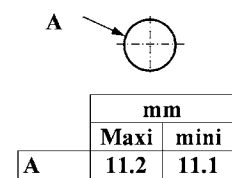

P09

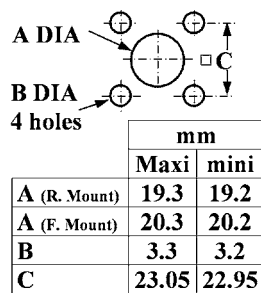

P10

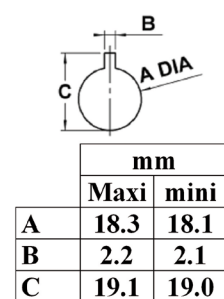

P11

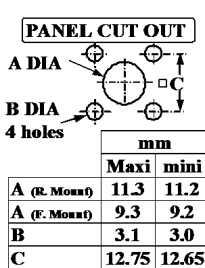

All dimensions are given in mm.

Introduction

Radiall . . . The Best Choice for Non-Magnetic Connectivity Solutions

We Know Your Market

We offer a range of non-magnetic RF connectors and cable assemblies for medical and space applications.

Why Radiall Is Your Best Choice

- **Collaboration:** We work closely with your engineers to understand your business, your technical needs, and your budget.
- **High Performance, Competitively Priced Products:** Our connectivity solutions give you the best combination of performance and value.
- **Wide Product Range:** We manage our product lines through the entire lifecycle, in order to offer you a wide selection of standard products at an affordable price.
- **Global Presence:** We're everywhere you need us, with worldwide sales, engineering support, R&D in North America, Europe, and Asia, and manufacturing facilities strategically located in the United States, Mexico, France, India, and China to provide on-demand cable assemblies.
- **Responsive Support and Service:** From the design stage, and planning to post-installation support, we're with you at every step, whether you need sales support or engineering expertise.
- **Warranty:** We stand behind our products.



Certifications and Environment

Radiall is ISO 9001:2008 certified and dedicated to continuous improvement programs that have resulted in AS9100, TS16949, and ISO 14001 certifications. In addition, Radiall is committed to investing in its people, future technologies, and the environment. Radiall is RoHS (Restriction of Hazardous Substances) and REACH (Registration, Evaluation, Authorization and Restriction of Chemical Substances) compliant.

The Best Manufacturing and Process Technologies

Our dedication to innovation and continuous improvement in leading-edge products means we excel in the techniques to create them:

- High precision machining: metal stamping, milling, turning, and cutting
- Molding, polishing
- Laser, ultrasonic, and vapor soldering
- Plating and plastic metallization
- Automatic assembly
- Characterization
- Test and measurement
- Cable and PTFE wrapping
- Thin and thick-film processes

Introduction

NON-MAGNETIC CONNECTOR FAMILIES

Radiall offers a growing range of non-magnetic connectors for medical, space, and other applications that includes MMCX, MCX, SMP, and SMB interfaces. To guarantee an exceptional non-magnetism level and repeatability, each non-magnetic connector is manufactured through a strictly controlled production process according to our quality assurance procedures.

For space applications, such as satellites used for scientific exploration, we offer an extensive range of SMA products, fully ESA qualified, meeting the residual magnetism required by the ESCC 3402 generic specification and the ESCC 3402/001, 002, and 003 detail specifications. Connectors are made of beryllium copper with gold plating and copper underplating.

NEW NON-MAGNETIC MCX SERIES

Radiall has expanded our range of non-magnetic connectors with the non-magnetic MCX series. These connectors meet the need for smaller interconnections in space-limited MRI equipment, such as those for head, shoulder, or foot. With more reliable connections through superior performance, the reinforced connection system eliminates the risk of perturbation in image quality.

The non-magnetic MCX family also includes a new full-detent cable version, which has been tested in high-vibration conditions, that eliminates intermittent connections. It complies with MIL-STD-202, Method 204, Condition D for vibration testing.

Non-magnetic MCX connectors are available in a wide range of configurations for:

- Board-to-board connections
- Cable-to-board connections
- Cable-to-cable connections

NON-MAGNETIC CABLE ASSEMBLIES

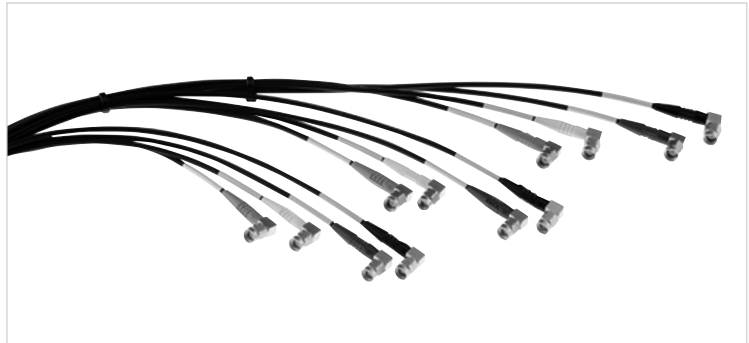

Radiall offers non-magnetic cable assemblies that provide a totally non-magnetic solution to reduce the risk of perturbation while working inside the B_0 magnetic field. Non-magnetic cables are available in RG/316, RG/178 flexible or .085" and .141" semi-rigid styles.

Introduction



CUSTOM PRODUCTS

We are continually developing new non-magnetic products, including high-density, multiposition configurations.

Multi-port connectors: We offer a wide variety of solutions for high-density coaxial contacts based on the standard SMP, Coaxipack 2, SMB and SMA ranges with additional multiple DC contacts. Our expertise and extensive knowledge in RF coaxial connector and cable assembly technology allows us to offer superior technical project support including those projects that need new coaxial connections developed. Multi-port connectors offer the advantage of having only one connector instead of several separate connectors to mate and unmate.

Non-magnetic RF CONNECTORS FOR MEDICAL

Non-magnetic coaxial connectors are used primarily inside MRI and other medical imaging equipment. Magnetic resonance imaging produces high-resolution cross-sectional images of the inside of the human body by exploiting radio frequency (RF) pulses. MRI technology has seen tremendous improvements in recent years with continued advances in technology, a small part of which is due to coaxial non-magnetic connectors.

MRI medical equipment consists of a large magnet or electromagnet to create an intense and homogenous magnetic field (0.3 to 7 T) that surrounds the patient, “gradient coils” to position the area under analysis, and two high-frequency coils. One coil transmits RF pulses of 20 to 300 MHz to excite the atomic nucleus in the area under analysis. The other coil receives a signal that constitutes the image after excitation. The output is sent to a computer for processing and display.

The quality of the picture depends mainly on the homogeneity of the magnetic field and on the signal-to-noise ratio. To avoid any interference in the field homogeneity, coaxial connectors and cables located in the magnetic field to connect the coils should be transparent relative to the field, which means their relative permittivity μ_r should be equal to 1.

High-quality non-magnetic connectors have extremely low magnetic susceptibility so that they are not magnetized by the fields created in the equipment.



Introduction

RADIALL NON-MAGNETIC CONNECTORS

Radiall connectors are specified for coils because they are manufactured with materials especially adapted to non-magnetism (with relative permittivity μ_r close to 1). Each rod of raw material is selected based on a direct measurement with a vibrant magnetometer, with the highest quality of surface plating such as BBR (Bright Bronze Radiall), or NPGR (gold plated over a non-magnetic nickel phosphorous).

Our non-magnetic connectors have a susceptibility of around 10^{-5} , as opposed to 10^{-2} for standard connectors made of brass/nickel materials. As a result, our non-magnetic connectors are transparent to the magnetic field, which means no field distortion, a higher SNR, and higher quality images.

Performance of Radiall non-magnetic RF connectors

Table of distortion comparison:

	Distortion at 10 mm $\Delta H/H_{\text{ext}}$ with $B_0=1.5$ Tesla	Magnetic susceptibility χ
Radiall non-magnetic connector	$\leq 5 \cdot 10^{-7}$	$\approx 10^{-5}$
Standard non-magnetic connector	$\approx 10^{-5}$	$\approx 10^{-3}$
Brass/nickel connector	$\approx 10^{-4}$	$\approx 10^{-2}$

The relative distortion of a magnetic field of 1.5 T, generated by Radiall non-magnetic connectors is only $5 \cdot 10^{-7}$ maximum, at a distance of 10 mm from the surface of the connector. Furthermore, they meet the electrical and mechanical characteristics required for any reliable coaxial connector. In addition, these connectors are extremely durable for medical applications.

Manufacturing

Manufacturing a Radiall non-magnetic connector involves a special "clean room" environment where all precautions are taken to avoid any contact with ferromagnetic materials during the machining and cleaning process. Radiall follows strict manufacturing guidelines through a quality assurance plan where documented rules are enforced throughout the production line. This quality assurance procedure guarantees the highest level of non-magnetism and repeatability for all Radiall non-magnetic connectors.

MMCX plug and PCB receptacle

RIGHT-ANGLE PLUG CRIMP TYPE FOR FLEXIBLE CABLE

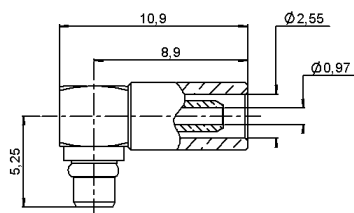

Cable group	Cable group dia.	Part number	Captive center contact	Body material	Finish
RG178 Non-magnetic cable	2/50/S	R110 170 147	yes	Non-magnetic bronze	BBR

STRAIGHT PCB RECEPTACLE

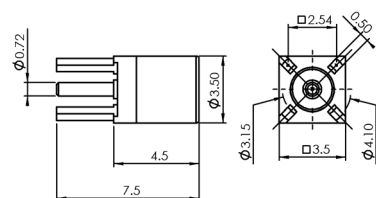

Part number	Captive center contact	Panel drilling	Body material
R110 426 107	yes	P01	Non-magnetic Bronze

MCX plug

STRAIGHT PLUG CRIMP TYPE FOR FLEXIBLE CABLE

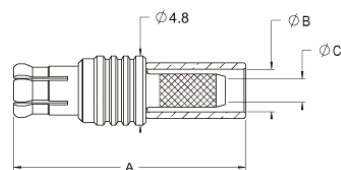

Cable group	Cable group dia.	Part number	Dimensions (mm)			Note	Finish
			A	B	C		
RG178	2/50/S	R113 081 097	16.1	2.55	1.1	—	BBR
RG316	2.6/50/S	R113 082 097	16.1	2.95	1.65	—	
RG316	2.6/50/S	R299 122 097	16.1	2.95	1.65	Full detent	

RIGHT-ANGLE PLUG CRIMP TYPE FOR FLEXIBLE CABLE

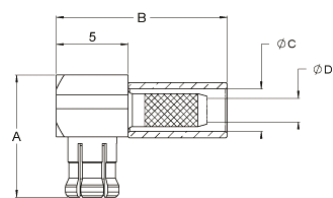

Cable group	Cable group dia.	Part number	Dimensions (mm)				Note	Finish
			A	B	C	D		
RG178	2/50/S	R113 181 097	8.6	11.9	2.55	1.1	—	BBR
RG316	2.6/50/S	R113 182 097	8.6	11.9	2.95	1.65	—	
RG316	2.6/50/S	R299 122 087	8.6	11.9	2.95	1.65	Full detent	

PRODUCT SPECIFICATION: please refer to the standard range

Our Most Important Connection is with You.™

MCX jack and PCB receptacles

STRAIGHT JACK CRIMP TYPE FOR FLEXIBLE CABLE

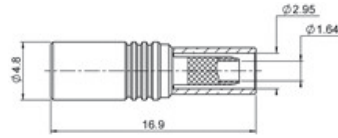

Cable group	Cable group dia.	Part number	Finish
RG316	2.6/50/S	R113 240 097	BBR

STRAIGHT PCB RECEPTACLE

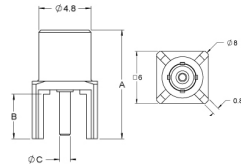
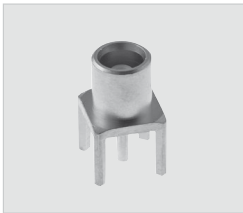

Fig. 1

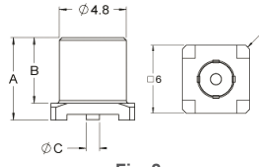

Fig. 2

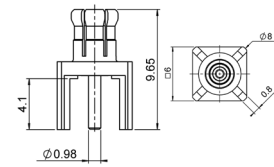
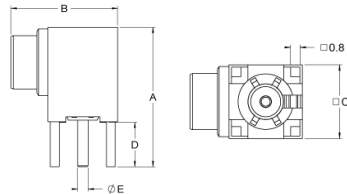

Fig. 3

Part number	Fig.	Dimensions (mm)			Panel drilling	Termination	Finish	Type
		A	B	C				
R113 426 097	1	10	4.1	0.98	P01	Solder legs	Gold over copper	female
R113 424 097	2	5.9	4.7	0.96	--	SMT		female
R113 425 097	3	9.65	4.1	0.98	P01	Solder legs		male

RIGHT-ANGLE PCB RECEPTACLE



Part number	Panel drilling	Termination style	Finish	Type
R113 665 097	P01	Solder legs	Gold over copper	female

SMP plug

RIGHT-ANGLE PLUG CRIMP TYPE FOR FLEXIBLE CABLE

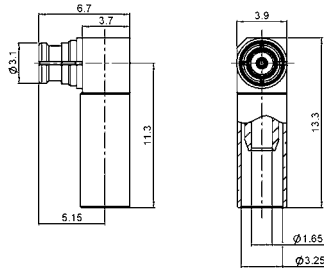
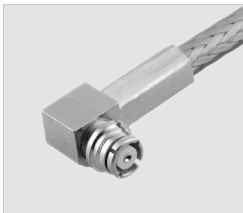

Cable group	Cable group dia.	Part number	Captive center contact	Body material	Finish
RG179 non-magnetic cable	2.6/50/S	R222 900 357	yes	Non-magnetic bronze	BBR

PRODUCT SPECIFICATION: please refer to the standard range

SMP receptacle

STRAIGHT SMT RECEPTACLE

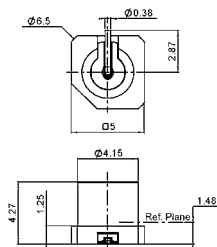

Part number	Retention	Captive center contact	Body material	Finish
R222 941 324	Limited detent	yes	Non-magnetic bronze	Gold over copper

SMB Plugs and jack

STRAIGHT PLUG FULL CRIMP TYPE FOR FLEXIBLE CABLE

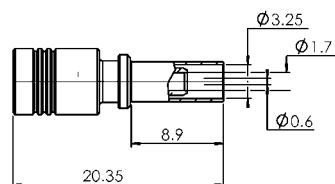

Cable group	Cable group dia.	Part number	Captive center contact	Body material	Finish
RG179, RG316 non-magnetic cable	2.6/50+75/S	R114 082 107	yes	Non-magnetic bronze	BBR

RIGHT-ANGLE PLUG CRIMP TYPE FOR FLEXIBLE CABLE

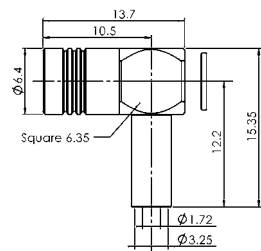
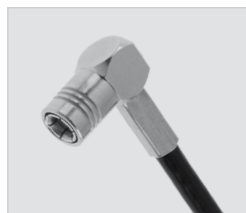

Cable group	Cable group dia.	Part number	Captive center contact	Body material	Finish
RG179, RG316 non-magnetic cable	2.6/50+75/S	R114 186 197	yes	Non-magnetic bronze	BBR

STRAIGHT BULKHEAD JACK CRIMP TYPE FOR FLEXIBLE CABLE

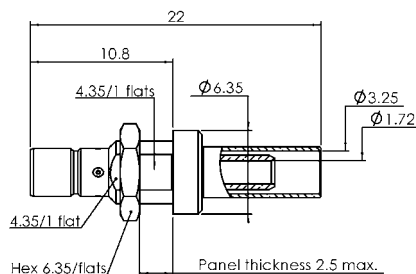

Cable group	Cable group dia.	Part number	Captive center contact	Panel drilling	Body material	Finish
RG316 non-magnetic cable	2.6/50+75/S	R114 313 197	yes	P02	Non-magnetic bronze	BBR

PRODUCT SPECIFICATION: please refer to the standard range

SMB receptacle

STRAIGHT MALE RECEPTACLE FOR PCB

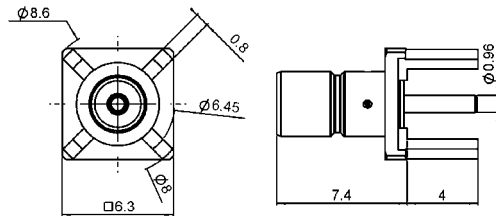

Part number	Body material	Finish
R114 426 147	Non-magnetic bronze	Gold over copper

RIGHT-ANGLE RECEPTACLE FOR PCB, SOLDER LEGS

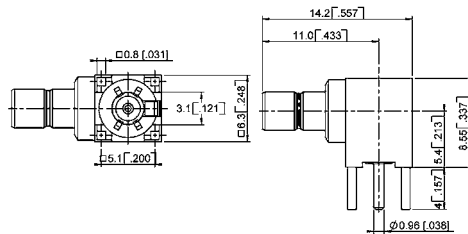
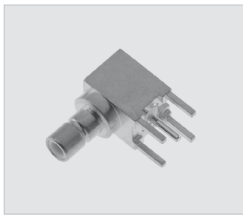

Part number	Captive center contact	Body material	Finish
R114 665 107	yes	Non-magnetic bronze	Gold over copper

BNC plugs and jack

STRAIGHT PLUG FULL CRIMP TYPE

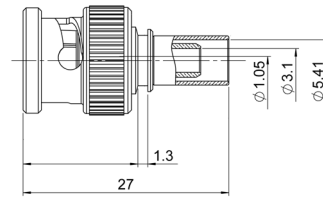

Cable group	Cable group dia.	Part number	Captive center contact	Body material	Finish
RG58 / RG141	5/50S	R141 082 097	yes	Non-magnetic bronze	BBR / Gold

RIGHT-ANGLE PLUG CRIMP TYPE FOR FLEXIBLE CABLE

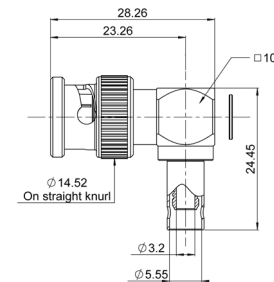

Cable group	Cable group dia.	Part number	Captive center contact	Body material	Finish
RG58 / RG141	5/50S	R141 182 177	yes	Non-magnetic bronze	BBR / Gold

STRAIGHT BULKHEAD JACK SOLDER TYPE FOR SEMI RIGID CABLE

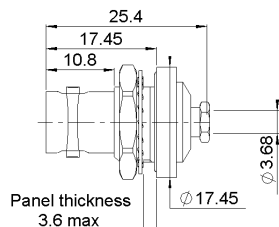
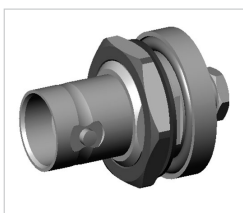

Cable group	Cable group dia.	Part number	Captive center contact	Body material	Finish	Note
RG402	.141"	R141 338 007	no	Non-magnetic bronze	BBR / Gold	Panel sealed

Cable terminals

RIGHT-ANGLE TERMINAL SOLDER TYPE FOR FLEXIBLE CABLES

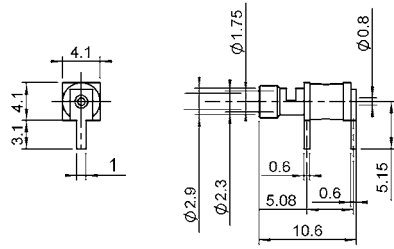

Cable group	Cable group dia.	Part number	Panel drilling	Body material	Finish
RG-174, RG-316, RD-316, RG-179, RD-179	2.6/50+75	R280 220 027	P03	Non-magnetic bronze	Gold over copper

STRAIGHT TERMINAL SOLDER TYPE FOR SEMI-RIGID CABLES

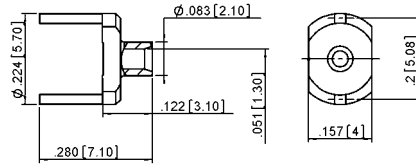
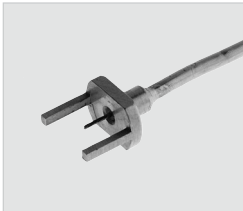

Cable group	Cable group dia.	Part number	Panel drilling	Body material	Finish
RG-174, RG-316, RD-316, RG-179, RD-179	.047	R280 287 107	P04	Non-magnetic bronze	Gold over copper

PRODUCT SPECIFICATION: please refer to the standard range

NON-MAGNETIC CABLE TERMINALS

Our Most Important Connection is with You.™

Non-magnetic cable assemblies

Radiall also offers a standard range of non-magnetic cable assemblies fit to work within the B₀ magnetic field. The cables are not sold separately.

In order to meet our customers specific project requirements, Radiall provides worldwide technical support.

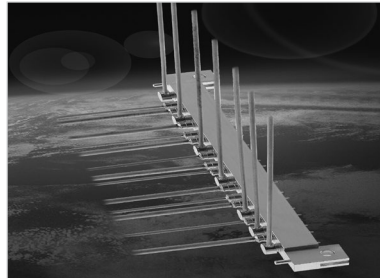

Cable type	Cable group dia.	Part number
RG-178 non-magnetic	2/50/S	C291 140 087
RG-316 non-magnetic	2.6/50/S	C291 170 079
RG-400 non-magnetic	5/50/S	C291 324 079
.085" semi-rigid	.085	C291 851 001
.141" semi-rigid	.141	C291 861 061

Panel drilling

P01

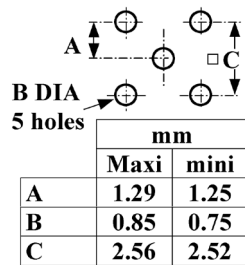

P02

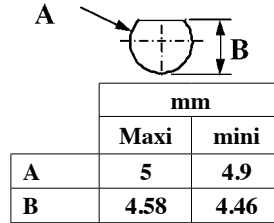

P03

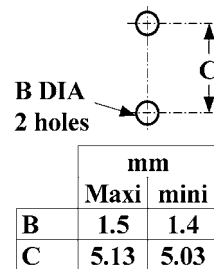

P04

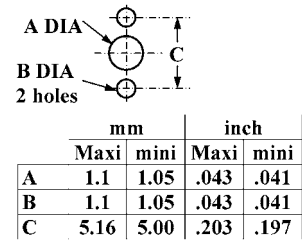

P05

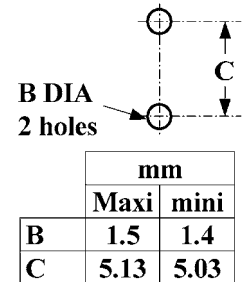

P06

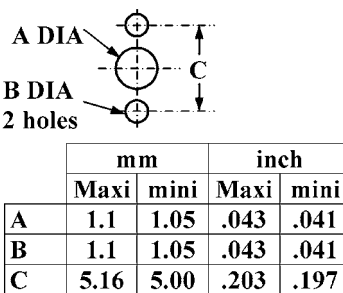

PRODUCT SPECIFICATION: please refer to the standard range