



## QUICK INSTALL (QR)

---



## Section 13 Table of Contents

**INTRODUCTION**

Introduction.....	13-2
Applications.....	13-2
Features & Benefits .....	13-2
Electrical Characteristics .....	13-2 to 13-3
Mechanical Characteristics.....	13-3
Environmental Characteristics.....	13-3

**QR SERIES**

QR Product Overview.....	13-4
How To Order QR Connectors.....	13-5
Polarization Code.....	13-6
QR Shell Dimensions .....	13-7 to 13-8
QR Shell Weights.....	13-9
QR Arrangements .....	13-10

**CONTACTS**

Signal & Power Crimp Contacts .....	13-11
Coaxial Crimp Contacts.....	13-12
Twinax & Triax Crimp Contacts .....	13-12
Quadrax & BMA Crimp Contacts .....	13-12
Fiber Optic Contacts & Q-MTitan.....	13-13
Sealing Plugs.....	13-13

**ACCESSORIES**

Accessories, Spare Parts & Tools .....	13-14 to 13-15
--	----------------

Introduction

## INTRODUCTION

The development of the Quick Install range (QR connector series) highlights Radiall's ability to innovate for customer needs and design a reliable and competitive industrial solution in record time.

Radiall's Quick Install is a lightweight solution that reduces harness integration and maintenance time. It can also replace EN3545 due to the same panel cutout. This new connector provides high performances, weight reduction and tool-less panel mounting and locking.

Utilizing Radiall's ability to design innovative solutions, this interconnect system was designed with two tool-less mechanisms that save up to 80% of installation time compared to the legacy screwed connector:

- A unique locking device system to ensure a quick, tool-less install on the panel
- A slide lock, which has already been mastered and qualified on other product ranges, to ensure instant manual mating of the harness connector. The slide technology features visual and audible indicators to guarantee that the installation and mating is locked.

## APPLICATIONS

The innovative Quick Install has a positive impact on the total cost of ownership and provides customers with a proven and reliable high performance solution for cable-to-cable, optical and equipment versions onboard commercial aircraft.

## FEATURES & BENEFITS

### 15% LIGHTER THAN THE COMPETITION



It features a unique design made of composite material with a slim form factor that provides 15% weight savings compared to the legacy screwed connector. With an average weight of 45 g per mated pair, the weight reduction represents up to 20 kg for a typical aircraft.

### 80% INSTALLATION TIME SAVINGS



- A unique locking device system to ensure a quick, tool-less installation on the panel
- A slide lock, which has already been mastered and qualified on other product ranges, to ensure instant manual mating of the harness connector

### A TOOL-LESS AND FOD-PROOF DESIGN



The Quick Install provides customers with a proven and reliable high performance solution that can replace the cable-to-cable, optical and equipment versions of EN3545.

### SELF INSPECTION AT MATING



The slide technology features visual and audible indicators guarantee that the installation and mating tools are locked.

## ELECTRICAL CHARACTERISTICS

### DIELECTRIC WITHSTANDING VOLTAGE

PRESSURE	CONTACT SIZE	CONNECTORS	
		MATED (VRMS)	UNMATED (VRMS)
Initial Measurement and After Damp Heat Steady State Test	22, 20, 16, 12 10, 08	-	1,300 (#22) 1,500
After Interfacial Sealing Test		1,300 (#22) 1,500	-
During Low Air Pressure Test (12,1kPa)		1,500	600



## Introduction

### INSULATION RESISTANCE

> 5,000 MΩ initial

> 1,000 MΩ after endurance at temperature, immersion at low air pressure, interfacial sealing and during fluid resistance test

### ELECTRICAL STRESS TESTS

- Power supply voltage spikes ABD0100.1.8 and ED14/DO160 section 17, 2,000 V
- Lightning functional link ED14/DO160 section 22.5.1 « pin injection test » - 5A – 1,500 V/1,500 A

### MECHANICAL CHARACTERISTICS

#### VIBRATION & SHOCK

SHELL TYPE	MATERIAL	VIBRATION	SHOCK
QR Series	Composite	4h/axis 0.017 g <sup>2</sup> /Hz from 10 to 50 Hz and 0.1 g <sup>2</sup> /Hz from 50 to 2,000 Hz (129 m/s <sup>2</sup> )  Discontinuities < 1 μs Discontinuities < 2ns for Quadrax Contacts  EN2591-403 Method B Condition D	50 g/Duration 11 ms EN2591-402 Method A

#### MATING/UNMATING

SHELL TYPE	MATERIAL	MATING/UNMATING	MATING FORCE
PANEL LOCKING	Aluminium	50 Cycles	30 N max
PLUG TO RECEPTACLE	Composite	100 Cycles	90 N max for Arrangement 12 80 N max for All Other Arrangements

#### OTHER CHARACTERISTICS

- **Interfacial Sealing Test:** 12.1 kPa with sealing plug
- **Flammability/Density/Toxicity** ABD0031 (AITM)
  - **Flammability**
    - Burn length (average) must not exceed 152 mm (6 inches)
    - After flame time (average) must not exceed 15 seconds
    - After flame time of drips (average) must not exceed 3 seconds
  - **Density**
    - Dm (flaming) < 200
    - Dm (non flaming) < 200
- **Toxicity**
  - Hydrogen Fluoride: 100 ppm max
  - Hydrogen Chloride: 150 ppm max
  - Hydrogen Cyanide: 150 ppm max
  - Sulfur Dioxide: 100 ppm max
  - Nitrous Gases: 100 ppm max
  - Carbon Monoxide: 1,000 ppm max

#### ENVIRONMENTAL CHARACTERISTICS

- **Temperature Range:** -55 °C/+175 °C
- **Temperature Life:** 1,000 hours at 175 °C
- **Salt Spray:** 96 hours
- **Humidity:** 56 days
- **Altitude Immersion:** (12,1 kPa) 3 cycles – 50,000 feet (15,000 m)

For more details, please refer to the QR qualification test report (C2020040019).

QR Series

**QR PRODUCT OVERVIEW**

The QR connector is composed of two subassemblies:

- A receptacle connector
- A plug connector

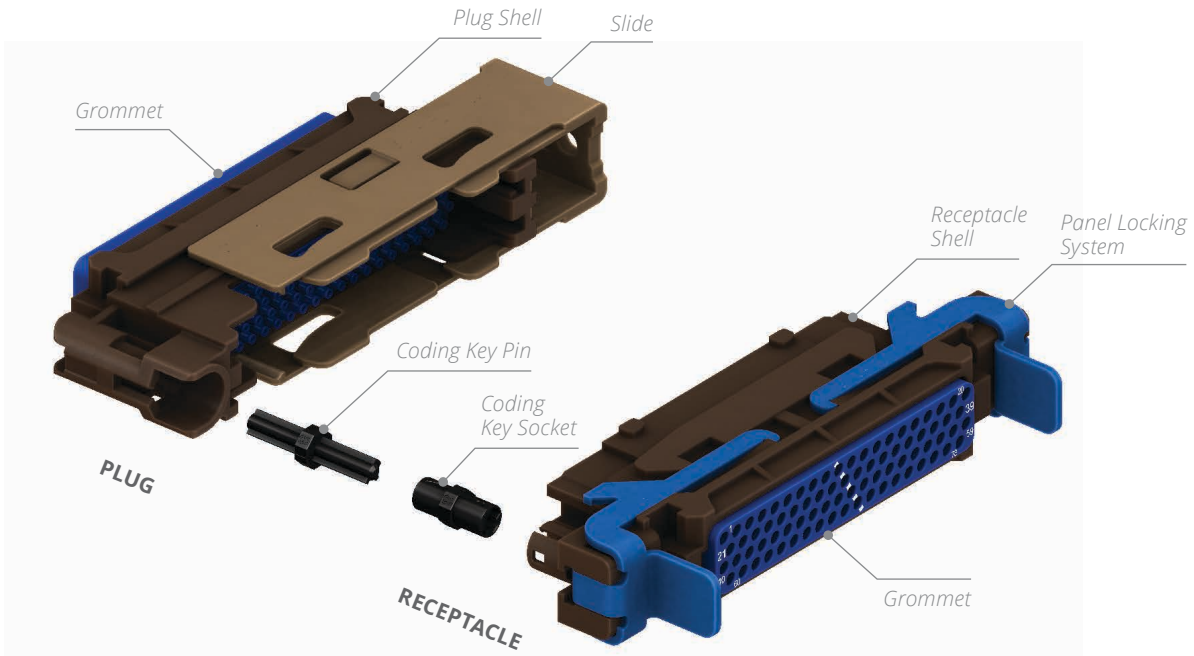

For each Receptacle/Plug, there is one version for male contacts and one for female contacts.

**STANDARD VERSION**

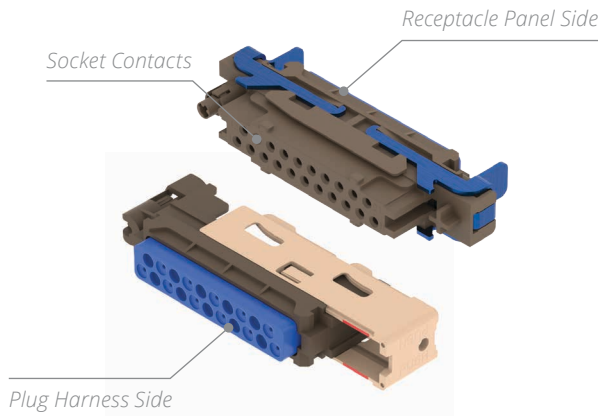

**REVERSED VERSION**

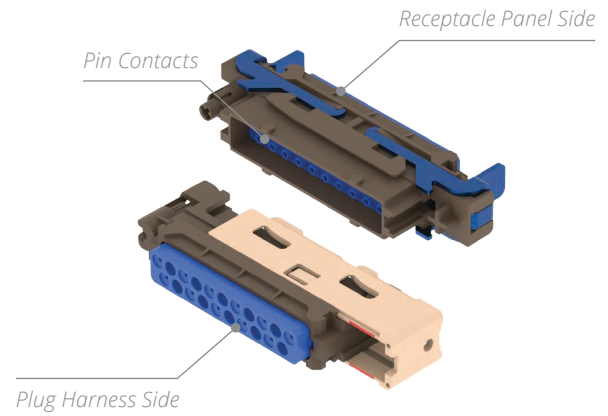

**Notes**

Except for the cavity change, the interior design of the shell is slightly different between a housing (socket or plug) for male contacts and its counterpart for female contacts

QR Series

HOW TO ORDER QR CONNECTORS

- Both pin and socket contacts can be used in plugs or receptacles.
- Standard versions are receptacle equipped with socket contacts and plug equipped with pin contacts.
- Reversed versions are receptacle equipped with pin contacts and plug equipped with socket contacts.
- Straight PC tail contacts are only compatible with receptacle for equipment.
- Cross reference between QR and EN3545 is not possible (not compatible).
- Connectors are delivered with a protective cover designed to protect the contact cavities from dust and FOD. Radiall recommends keeping the cap installed while the connector is not mated or while access to the active area is not necessary.

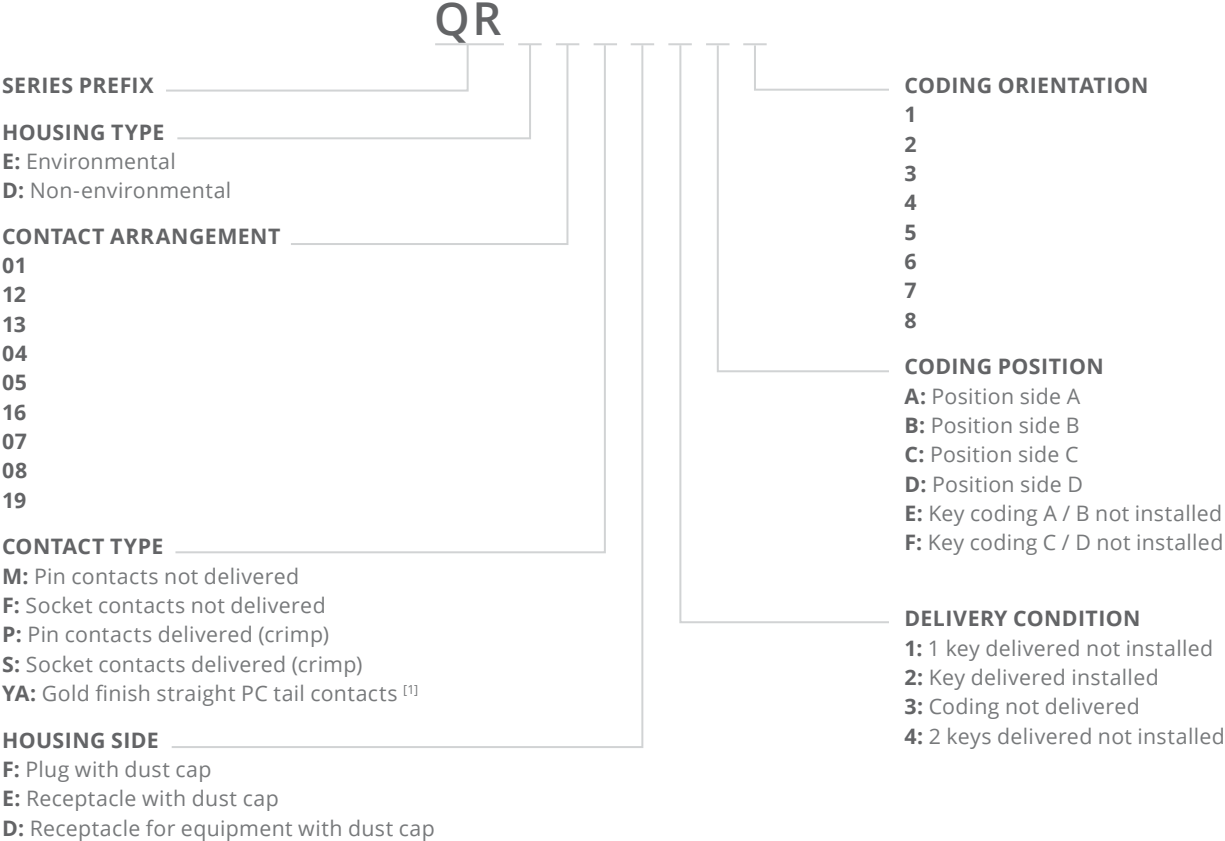

Notes

1. For other PC tail extension options, please contact us

QR Series

**POLARIZATION CODE**

QR

SERIES PREFIX \_\_\_\_\_

HOUSING TYPE \_\_\_\_\_

P: Plug

R: Receptacle

CODING KEY \_\_\_\_\_

E: Key coding A / B not installed

F: Key coding C / D not installed

The polarization is made with 2 pairs of modular keys to ensure a coding of each arrangement. There are 4 modular coding keys (2 for the receptacle and 2 for the plug). Every key has 2 sides (A and B or C and D). To ensure proper mating between them, the coding shall be the same on plug and receptacle connectors (for example, coding A2 for both keys).

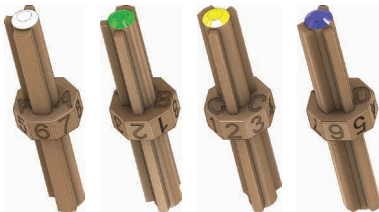
	PLUG	RECEPTACLE
QR		
CODING DEVICE	 <p>View A View B View C View D</p>	 <p>View A View B View C View D</p>

QR Series

### QR SHELL DIMENSIONS PLUG

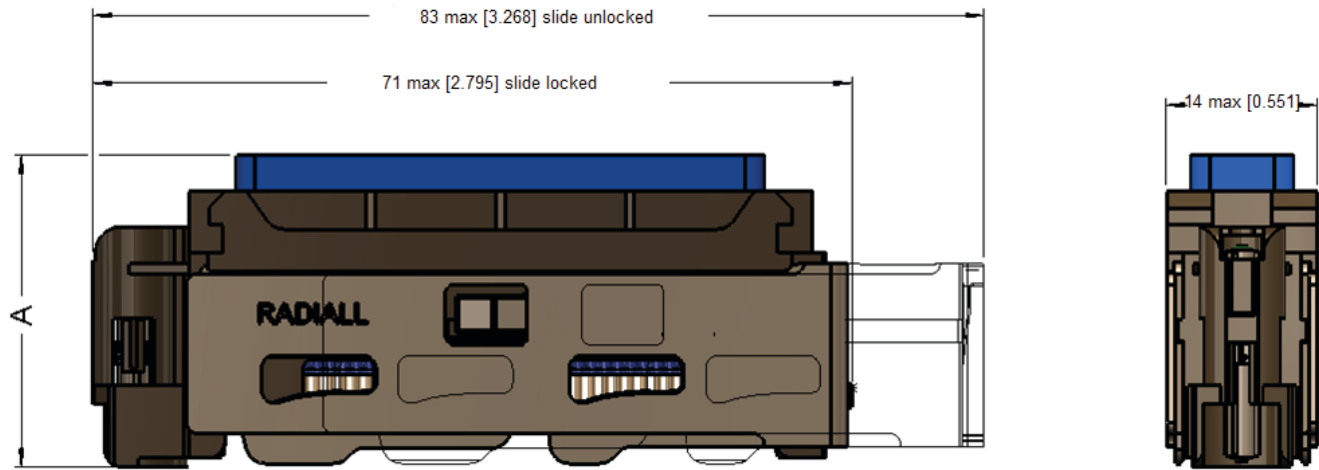

### RECEPTACLE

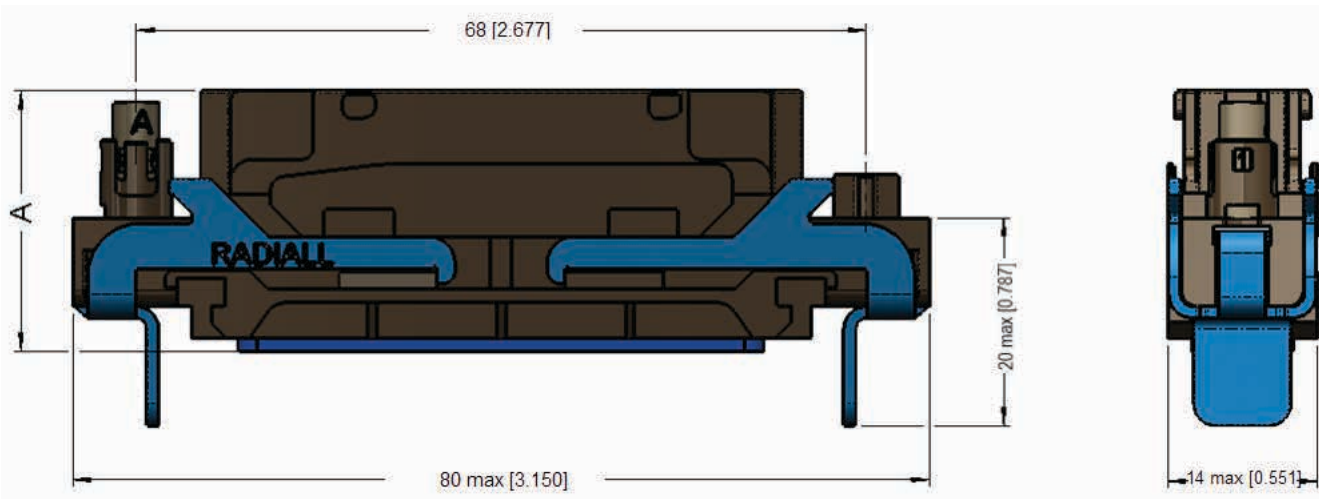

INSERT NAME	GROMMET PROTRUSION (A) MAX MM (INCH) FOR RECEPTACLE	GROMMET PROTRUSION (A) MAX MM (INCH) FOR PLUG
01, 04, 05, 12, 13	27 [0.984]	31.50 [1.102]
07, 08	32 [1.181]	33.50 [1.220]
16, 19	37.50 [1.614]	41.50 [1.614]

PANEL CUT-OUT STANDARD QUICK INSTALL

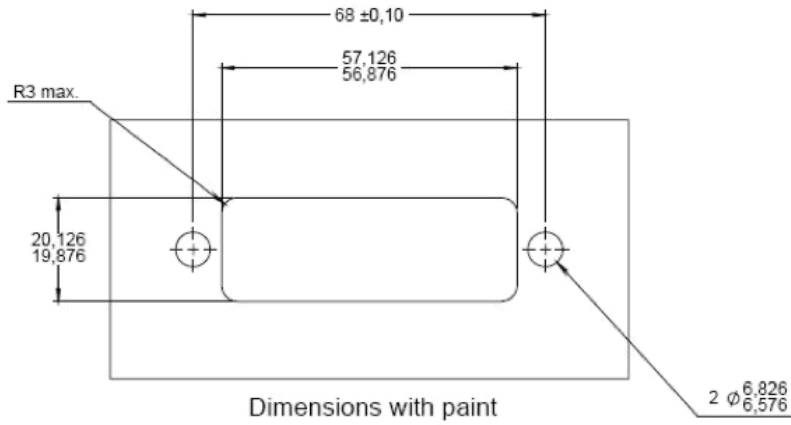

PANEL CUT-OUT QUICK INSTALL EQUIPMENT

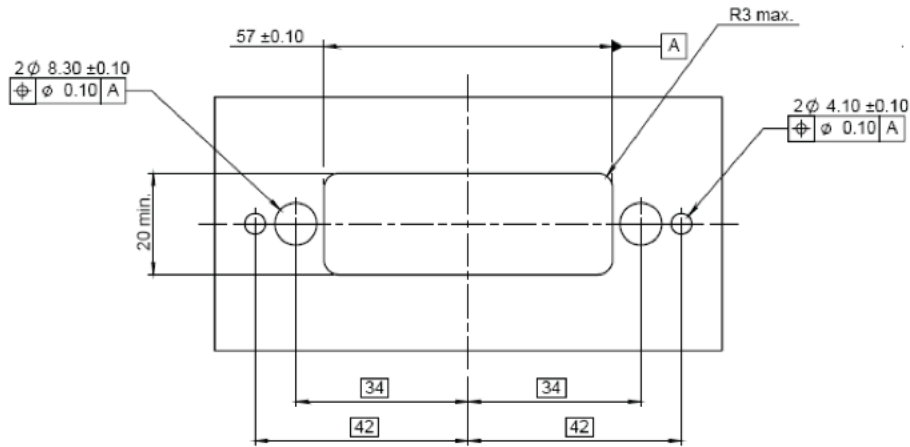

QR Series





### QR SHELL WEIGHTS

HOUSING SIDE	CONTACT ARRANGEMENT	WEIGHT	
		WITH CAVITIES FOR PIN CONTACTS (M)	WITH CAVITIES FOR SOCKET CONTACTS (F)
<b>PLUG (P)</b> 1 CODING KEY INCLUDED	01	22g	23g
	12	22g	23g
	13	22g	24g
	04	22g	23g
	05	22g	23g
	16	25g	26g
	07	22g	24g
	08	22g	24g
	19	22g	24g
<b>RECEPTACLE (R)</b> 1 CODING KEY INCLUDED	01	23g	25g
	12	23g	25g
	13	23g	25g
	04	23g	25g
	05	23g	24g
	16	25g	27g
	07	23g	25g
	08	22g	26g
	19	22g	25g

QR Series

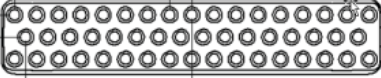
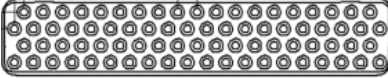
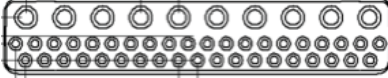
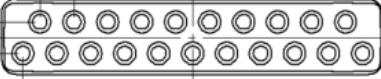
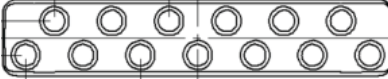
QR ARRANGEMENTS

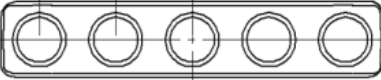
CONTACT ARRANGEMENT NAME	CONTACT SIZE & TYPE						TOTAL QUANTITY OF CONTACTS
	22	20	16	12	10	8	
	SIGNAL	POWER	POWER	POWER	POWER OR TRIAXIAL	POWER OR QUADRAX OR TWINAX OR TRIAX	
07	-	-	-	-	-	5	5
16	-	-	-	-	7	-	7
05	-	-	-	13	-	-	13
04	-	-	21	-	-	-	21
08	-	18	-	-	-	3	21
19	-	25	12	-	-	-	37
13	39	-	10	-	-	-	49
01	-	50	-	-	-	-	50
12	78	-	-	-	-	-	78

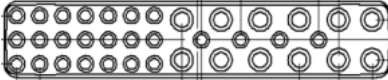
		
<b>Arrangement 01:</b> 50 Contacts #20	<b>Arrangement 12:</b> 78 Contacts #22	<b>Arrangement 13:</b> 39 Contacts #22 10 Contacts #16
		
<b>Arrangement 04:</b> 21 Contacts #16	<b>Arrangement 05:</b> 13 Contacts #12	<b>Arrangement 16:</b> 7 Contacts #10
		
<b>Arrangement 07:</b> 5 Contacts #8	<b>Arrangement 08:</b> 18 Contacts #20 3 Contacts #8	<b>Arrangement 19:</b> 25 Contacts #20 12 Contacts #16



Contacts

**SIGNAL & POWER CRIMP CONTACTS**

**ELECTRICAL CHARACTERISTICS**

Signal & Power Crimp Contacts for Copper Cables

CONTACT SIZE	WIRE SIZE	TYPE	PART NUMBER	CRIMPING TOOL	POSITIONER	SELECTOR OR JAWS	INS/EXT TOOL
22	AWG22 AWG24 AWG26	Pin	670200 (M39029/58-360) (EN3155-008P2222)	282281 (M22520/2-01)	282562 (M22520/2-09)	2 3 4	282522 (M81969/14-01)
		Socket	670350 (M39029/57-354) (EN3155-003S2222)				
20	AWG22 AWG20 AWG18	Pin	628220 (EN3155-014M2022) (EN3155-014M2020) (EN3155-014M2018)	282281 (M22520/2-01)	(M22520/2-08)	2 3 4	282522001 (M81969/39-01)
		Socket	628320 (EN3155-015F2022) (EN3155-015F2020) (EN3155-015F2018)				
16	AWG16 AWG18 AWG20	Pin	670230 (M39029/58-364) (EN3155-008P1616)	282291 (M22520/1-01)	282567 (M22520/1-04) Blue	4 5 6	282515 (M81969/14-03)
		Socket	670380 (M39029/57-358) (EN3155-003S1616)				
12	AWG12 AWG14	Pin	670240 (M39029/58-365) (EN3155-008P1212)	282291 (M22520/1-01)	282567 (M22520/1-04) Yellow	7 8	282549004 (M81969/14-04)
		Socket	670390 (M39029/57-359) (EN3155-003S1212)				
10	AWG12 AWG10	Pin	(EN3155-008M1010)	282296 (Manual Crimping Tool) (M22520/23-01) Pneumatic Crimping Tool	DMC TP1526	2 4	282549033 (M81969/14-05)
		Socket	(EN3155-003F1010)				
8 <sup>[1]</sup>	AWG10 AWG08 AWG06	Pin	ABS1403-1K6KZ10 ABS1403-1K6KZ08 ABS1403-1K6KZ06	M22520/23-01	DMC WA23-296	DMC WA23-101DA DMC WA23-2 DMC WA23-2	282549031 (M81969/14-12)
		Socket	ABS1344-1K6LZ10 ABS1344-1K6LZ08 ABS1344-1K6LZ06				

**PERMISSIBLE CONTACT & CABLE <sup>[2]</sup>**

SLEEVE CODE	SLEEVE SIZE CODE	PERMISSIBLE CONTACT	EXAMPLE OF PERMISSIBLE CABLE	ØA OUTER Ø OF CABLES
B D	01	Quad ABS0973/ABS0974 Quad ABS1581/ABS1582	KH24 ABS1580 KD24 ABS1503	4.70 4.10
		ABS1380/ABS1381 K6 ABS1344/ABS1403	AD08 ABS0949/ABS1354 DR08 EN2267	
B D	02	ABS1380/ABS1381 K6 ABS1344/ABS1403	AD10 ABS0949/ABS1354 DR10-12 EN2267	3.70 2.08
		Twinax ABS1111/ABS1112	WF24 ABS0386 <sup>[3]</sup> TK22 ASNE0272 <sup>[3]</sup>	
		Coax ABS1055/ABS1056	EN4604-003WZ	
		Optical ABS1379-003	ABS0963LF	
B D	03	K6 ABS1344/ABS1403	DR06 EN2267	5.70 5.30

**Notes**

1. These contacts should be used with an ABS0922BD01 sealing sleeve
2. Dimensions in millimeters
3. Please contact Radiall for oversized and reduced crimp barrel contacts

## Contacts

## COAXIAL CRIMP CONTACTS

### SIZE 8 COAXIAL CRIMP CONTACTS

CONTACT SIZE	CABLE TYPE	CONTACT GENDER	PART NUMBER	INS/EXT TOOL
8 <sup>[1]</sup> <sup>[2]</sup>	RG400 (ASNE0293XF)	Pin	691800021	(M81969/14-12)
		Socket	691810020 691810021	
	EN4604-003WZ (Draka F1703-195)	Pin	691800020	
	EN4604-005WL (ASNE0690WL Draka F1703-158)	Socket	619054002	
		Pin	619156002	

## TWINAX & TRIAX CRIMP CONTACTS

### SIZE 8 TWINAX CRIMP CONTACTS

CONTACT SIZE	CABLE TYPE	CONTACT GENDER	PART NUMBER	INS/EXT TOOL
8 <sup>[3]</sup>	ABS0386WF24 (Draka F2703-37)	Pin	617165014	(M81969/14-12)
		Socket	620065010	
	EN3375-009WX26 (ASNE0807WX26 Nexans ET133199)	Pin	628165012	
		Socket	620065012	

### TRIAx CRIMP CONTACTS

CONTACT SIZE	CABLE TYPE	CONTACT GENDER	PART NUMBER	INS/EXT TOOL
8 <sup>[3]</sup>	EN3375-004 EN3375-005	Pin	691800071	(M81969/14-12)
		Socket	691800171	
	EN3375-003	Pin	691800070	
		Socket	691800170	
	EN3375-004CWJ24	Pin	ABS2231P02	
		Socket	ABS2231S02	
10	EN3375-006XM24 (ASNE0290XM24)	Pin	691800090	282549033 (M81969/14-05)
		Socket	691800190	

## QUADRAX & BMA CRIMP CONTACTS

### SIZE 8 QUADRAX CRIMP CONTACTS

CONTACT SIZE	CABLE TYPE	CONTACT GENDER	PART NUMBER	INS/EXT TOOL
8 <sup>[4]</sup>	ABS0972KB24 (Draka F4704-4) ABS1503KD24 (Draka F4704-5)	Pin	617175012 628175070 <sup>[5]</sup>	(M81969/14-12)
		Socket	620075010 620075070 <sup>[5]</sup>	
	NF26Q100	Pin	617175054	
		Socket	620075021	
	NF22Q100	Pin	617175040	
		Socket	620075040	
	JSFY02	Pin	628179002	
		Socket	620079002	
	P506424	Pin	628179011	
		Socket	620079011	

#### Notes

1. Contacts for RG400 should be used with an ABS0992BD01 sealing sleeve
2. Contacts for WZ and WL cables should be used with an ABS0992BD02 sealing sleeve
3. These contacts should be used with an ABS0922BD02 sealing sleeve
4. These contacts should be used with an ABS0922BD01 sealing sleeve
5. Gold plating 0.8µm only

Contacts





**FIBER OPTIC CONTACTS & Q-MTITAN  
QR COMPATIBILITY**

Fiber optic contacts EN4531 with adapters in size 8 cavities are available with arrangements 07 (up to 5 contacts) and 08 (mix of optical and electrical contacts) <sup>[1]</sup>

12-channel Q-MTitan ARINC 846 fiber optic contact fits size 8 Quadrax cavities without adapters (5 Q-MTitan = 60 fiber optic in a Quick Install connector) <sup>[1]</sup>

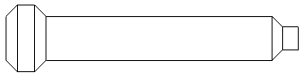
**SEALING PLUGS**

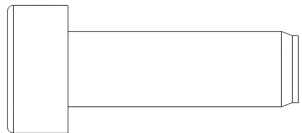
Sealings plugs are dedicated to environmental insert cavities.

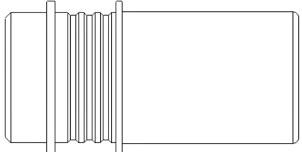
SIZE	CONTACT CAVITY VERSION	COLOR	PART NUMBER	DRAWING
22	For Pin & Socket	Black	E0616BC2200	
20		Red	E0616BC2000	
16		Blue	E0616BC1600	
12 & 10		Yellow	E0616BC1200	
08		Red	E0616BC0803	

**Notes**







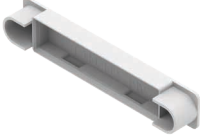

1. Not qualified, please contact Radiall.

The QR range has no filler plug because the sealing is guaranteed without utilizing dummy contacts for the cavities that are not populated

The head shall be installed in mechanical abutment or flush with the connector grommet

Accessories

**ACCESSORIES, SPARE PARTS & TOOLS**

	PART NUMBER	DESCRIPTION
	628 954 001	Receptacle Dust Cap
	628 954 002	Plug Dust Cap
	282 654 001	Cable Clamps for Electrical Contacts for Easier Disconnection for Test Bench
	282 654 002	Cable Clamps for Quadrax Contacts for Easier Disconnection for Test Bench
	282 700 500	Set of Mounting Tools for Key A, B, C, D
	282 700 100	Tool for Coding Key A – White <sup>[1]</sup>
	282 700 200	Tool for Coding Key B – Green <sup>[1]</sup>
	282 700 300	Tool for Coding Key C – Yellow <sup>[1]</sup>
	282 700 400	Tool for Coding Key D – Blue <sup>[1]</sup>

**Notes**

1. Tools for coding key are compatible with receptacle and plug.

---

*Accessories***ACCESSORIES FOR CABLE**

The Quick Install series is compatible with a wide range of standard cable clamp accessories.

The Quick Install plug and receptacle are suitable for use with EN3545 straight and right angle cable clamps for standard contacts and size 8 contacts.

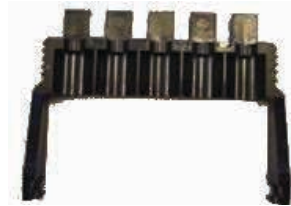

Notes