

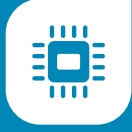

FIBER OPTIC



ACTIVE OPTICS



Fiber Optic Products
Full Line Catalog



Connectivity has a profound and dramatic impact on the lives of people throughout the world. Because of advancements in technology, **our** lives are more convenient, more secure, more enjoyable and richer than ever. The speed of data enables communication in the **most** remote areas so people can reach all corners of the globe, allows for **important** defense and security, and facilitates space exploration. But technology doesn't just happen. It starts in the mind with ideas, making **connections** never considered in ways that nobody dreamed possible. Seeing the future in ways previously unimagined **is** the act of innovation and it begins with people—the inventors, the dreamers, the pioneers and the engineers—enriching the lives of billions. At Radiall, we have one single, solitary mission; Empower the people that enrich our lives. Enable their innovation by providing reliability and durability. Give them useful information and provide them with valuable guidance when determining the best course for success. We don't invent the future, we enable it. We inspire innovation, we embrace challenges, we challenge the conventional and we collaborate **with** you to succeed. At Radiall, we're proud to say – Our most important connection is with **you**.

Table of Contents

LuxCis® ARINC 801 Contacts F725	1
LuxCis® ARINC 801 Interconnect Solutions	2
Expanded Beam Solutions F739, F746, F730	3
LC Series F727 SC Series F728 ST Series F709	4
RXF Series F760/RXF	5
R2CT® Series R2CT	6
OSIS® Series OSIS	7
OPUS Series OPUS	8
Cable Assemblies, Harnesses and Optical Systems	9
Active Optics	10
Tool Kits and Accessories F718/F780	11
Technical Information and Glossary of Terms	12
Part Number Index	13

Company Profile

Our Most Important Connection is with You™

Radiall is a global leader in the design, development and manufacturing of leading edge interconnect solutions. Dedicated to understanding its customers' needs since 1952, Radiall has earned the reputation of being "the best of the best" in engineering ingenuity by providing a constant flow of creative system solutions serving the defense, telecommunications, aerospace, instrumentation, automotive, industrial, medical and broadcast markets.

Best Value-added Services

Collaboration: We work closely with your engineers to understand your business, your technical needs, and your budgetary issues.

Wide Product Range: We manage our product lines thru the entire lifecycle in order to offer you a wide selection of standard products at an affordable cost.

Custom Products: We can tailor products to specific equipment and application needs.

Global Presence: We're everywhere you need us, with worldwide sales, engineering support, R&D in North America, Europe, and Asia, and manufacturing facilities strategically located in the United States, Mexico, France, India, and China.

Responsive Support and Service: From the design stage, planning to post-installation support, we're with you at every step, whether you need sales support or engineering expertise.

On-time Delivery: We support your logistical needs so you get the products when and where you need them.

Warranty: We proudly stand behind our products.

Certifications and Environmental

Radiall is ISO 9001: 2008 certified and dedicated to continuous improvement programs that have resulted in also being AS9100, TS16949 and ISO 14001 certified. In addition, Radiall is committed to investing in its people, future technologies and the environment, such as being RoHS (Restriction of Hazardous Substances) and REACH (Registration, Evaluation, Authorization and Restriction of Chemical substances) compliant.



The Best End-to-End Interconnect Solutions

We offer an extensive range of solutions that supports the most demanding signal transmission applications. 4G wireless infrastructure, active array radars, IED's detection, electrical wiring in aircrafts, soldier tactical radios, in-vehicle communications networks, and magnetic resonance imaging systems are just a few of the complex applications that we support.

- RF coaxial connectors
- Fiber optic connectors and transceivers
- Coaxial and fiber optic cable assemblies and harnesses
- High frequency microwave components
- Coaxial switches, including the smallest and most reliable SPDT relay
- Multipin rectangular connectors
- Rack and panel connectors
- Antennas for tactical networks, aerospace and instrumentation



Technical information and sales contacts are available at:
www.radiall.com

Radiall at a Glance

Worldwide Presence

Radiall has a global manufacturing presence. Our International sales network and qualified distributors cover every region around the world. The result is quick and insightful answers to all your requests.

- International Sales Network
- Low cost facilities
- Local manufacturing, logistics and technical support



North America



Asia



Europe



Market Focus

Aerospace



Defense



Industrial



Space



Telecom



Instrumentation



Medical



Radiall Technologies

- Milling
- Plating & plastic metallization
- Molding
- Characterization
- Polishing
- Laser, ultrasonic, vapor, soldering
- Stamping
- Thin & thick film processes
- Etching on Si
- Thick film on AlN
- Test & measurement
- Simulation
- Cable & PTFE wrapping
- Automatic assembly
- Micro-machining



A Global Range to Meet Your Needs



RF Coaxial Connectors

Radiall proudly offers the widest range of RF Coaxial Connectors in the Industry with over 12,000 part numbers and 72 product series including AEP® Mil QPL connectors. These precision-made components are a significant part of our heritage and essential to who we are.



RF & Microwave Switches

All Radiall switches provide exceptional reliability and performance. A unique modular and patented design of the actuator and transmission link enables Radiall to guarantee operation up to 10 million cycles with excellent repeatability, while reducing delivery times.



Microwave Components

Radiall has a wide range of coaxial devices, including terminations, attenuators, and couplers using standard interfaces from low to high power. Our state of the art techniques enable us to produce microwave components for use in commercial, military, and space applications.



Antennas

Radiall provides highly reliable antenna solutions for industrial and military applications. Our solutions include Line-Of-Sight tactical communications, vehicular mount, GPS, telemetry, and mesh networks. For optimum performance requirements, Radiall offers custom antenna solutions and support.



Multipin Connectors

Radiall has an unmatched range of rack and panel connectors and the most innovative modular and tool-less connectors used in harnesses and equipment connections. Our modern designs combine light weight, high performance levels and user friendly features to simplify even the most complex connections.



RF Cable Assemblies

Radiall has an extensive range of cable assemblies with outstanding electrical performance, low loss, and high frequency. Our range includes flexible, semi rigid and handformable cable assemblies. Our TestPro™ range meets the stringent requirements needed for test and lab applications.



Space Qualified

Industry leaders across the globe recognize the Radiall brand for quality, reliability, and performance. Our Space Qualified passive product offering includes a wide range of coaxial connectors, cable assemblies, microwave components, and switches with a frequency range up to Ka band.



D-Lightsys®

Active Optical Solutions Optimized by D-Lightsys® for harsh environments. From optical transceivers to the world's smallest parallel optics, D-Lightsys® technologies support the most challenging applications, including harsh environments and avionics applications.



Harnesses

The combination of design and manufacturing of RF and microwave cables as well as multipin connectors (EPX, ARINC 404 and 600) allows Radiall to be a specialist of harnesses for onboard or land equipment or communications systems. All types of contacts can be used and mixed such as signal, power, RF, quadraX, fiber optic...



Fiber Optics

Radiall designs and supports high performance end-to-end Optical Interconnect solutions. Our offer includes standard interfaces, termini, connectors, harnesses and custom design optical links and subsystems. The flexibility and high quality of our product range supports harsh environments and demanding applications.

Packaging

Shipping information

Unless otherwise stated, shipping lead times may vary depending on the location and time zone in which products are stocked or manufactured. The packaging defines the container of first level of a product. Radiall offers five types of standard packaging.



Labeling

Labeling has an important role in packaging. It has to supply all the necessary information in a clear and concise way. All of our packages are identified with the Radiall name, part number, lot number and quantity.

Blister tray

DEDICATED TO LARGER CONNECTORS • ABILITY TO STACK SEVERAL TRAYS WITHOUT DAMAGING THE CONNECTORS



- This specific packaging is suitable for large or fragile connectors. Products are vertically arranged in custom trays, providing protection against shock and making it easy to quickly count quantity.
- They are covered by an anti-dust lid or wrapped with a plastic film.
- This packaging is available for specific types of connectors when standard packaging might cause damage during shipping.

Tape and reel



- Products are arranged in an anti-static polyester blister tape covered with a ribbon defender. The set is then rolled up on a polyester reel which can receive 100, 500, 1800 or 3000 parts depending on the model.
- This packaging, dedicated to surface mount components is compatible with all pick and place automatic machines. It is CEI 286-3 compliant.

Bulk bag

BULK BAG OR BOX OF 100 PIECES BODY + CRIMP FERRULE + CENTER CONTACT



- The multiple bag or box contains 20, 50, or 100 of each component part in separate bags.

Packaging

Unit packaging

- All connectors can be ordered in unit bags. It is an individual tear-proof polyethylene bag, which holds the connector and all of the component parts for that connector.
- Unit packaging must be specified when ordering: add « W » at the end of the part number (except for adapters and specific products).

Pre-cut unit bag (no cutting tool required to open)



unit bag



Blister bulk pack

FOR MULTI-PART PRODUCTS • EASY TO OPEN • IDEAL FOR IN THE FIELD ASSEMBLY

- This bulk packaging is suitable for small connectors Radiall offers four types of blister bulk pack depending on the configuration of the product and the number of pieces (10, 20, 50, or 100).

Three compartments blister bulk pack of 20 pieces



Shipping box

Radiall has designed multiple boxes for optimum packaging and protection. These boxes are available in various optimized sizes.

- Eco friendly design
Labeled tape makes it easy to identify Radiall goods. Printing is minimized in order to limit the use of toxic substances. All boxes can be recycled (except for the adhesive).
- Each product part number has a dedicated carton box adapted to the size of its packaging
- All individual boxes are typically placed in size 20L shipping boxes (40x30x20 cm).

Radiall Optical Connection

Radiall Fiber Optic Timeline

2013

Radiall New Haven (USA) is a new design center for Fiber Optics to support our North American customers.

2008

Acquisition of D-lightsys, an innovative high-tech start-up specialized in optoelectronic components for harsh environments. Radiall reinforced its position as an innovative leader for optoelectronic interconnection components.

2003

Radiall's LuxCis® contact is voted as the FO interconnect solution for aerospace applications by airlines and the ARINC committee and is described in the ARINC 801 specification.

First flight for the LuxCis®.

1990

Isle d'Abeau (France) facility becomes the Radiall center of expertise for Fiber Optics.

1984

First FTTH application with the deployment of a fiber optic network in Biarritz, France, showcased Radiall's ability and process efficiency with innovative FO products.

1976

The potential of optical fiber launched Radiall's grand adventure with Fiber Optics.

1970

Demonstration of an optical fiber with a measured attenuation of less than 20 dB per km

End-to-End

Radiall designs, manufactures and markets high performance fiber optic components and end-to-end optical systems for the most demanding applications for the industrial, defense, and aerospace industries.

Aeronautic and Defense

Radiall works with major companies to enable and expand the use of FO technology in demanding environments.

Collaboration

Radiall is first choice for national military programs and collaborates with France Telecom in developing the national telecommunication network.

CNET

Through study contracts with CNET (National Telecommunication Studies Center) Radiall has researched and developed fiber optic technologies.



Radiall Optic Revolution

Lighter, Smaller, Higher Performance, More Cost Effective, More Secure

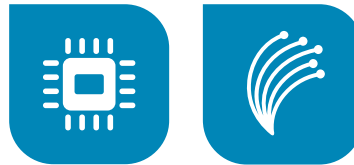

From theory to practical applications, fiber optic technology has advanced tremendously in terms of performance, quality, reliability, and versatility. The quality of today's glass fiber, combined with improved system electronics, enables fiber to transmit digitized light signals hundreds of kilometers. With low transmission losses, low interference, and high bandwidth potential, optical fiber is the ideal transmission medium.

Fiber optic benefits:

- High bandwidth
- Very lightweight & small form factor
- Immunity to Electromagnetic Interference (EMI)
- Low power loss
- Enhanced data security
- Non-conductivity eliminating spark hazards

Looking Forward



















The advantages provided by optical fiber systems are the result of a continuous stream of product innovations and process improvements. As the requirements of optical fiber systems are better understood, optical systems are improved to meet the needs of emerging opportunities.

Industry Needs and Environmental Challenges

Today industries requirements are more and more demanding. Transmissions have to satisfy customer and environmental specifications while expanding needs for reliability, performance, flexibility, cost optimization and efficiency. Optical solutions have to address complex challenges in different types of environments.

Harsh	In harsh environments, optical systems are exposed to temperature range from -55° to +125°C and beyond. The solutions chosen to deliver high optical performance in these conditions often require lightweight, small form factor, ruggedization and reliable alignment accuracy.
Tactical	Interconnection in tactical environment needs to withstand extreme conditions involving ruggedized design and easy to connect solution. Protection from high compressive and tensile loads, dust and dirt and ingress of water are some of the main requirements.
Outdoor	In outdoor environments, optical systems face severe conditions with temperature from -40° C to +85° C. They require robustness, ease of deployment and high optical performance systems.
Indoor	Indoor environments provide a stable operational condition with temperature from -20° C to +70° C and require high bandwidth, durability and cost optimization.

Applications

		Example applications											Industries													
		Civil Avionics & Equipment	Radar (RF-over-fiber)	Sensors	IFE	Power & Flight Management	Radar (RF-over-fiber)	Sensors	Missiles & Weapons Systems	Electronic Warfare	Mil Aero & Airframe	Tactical Communication	Energy / Oil & Gas	Smart Grid	Broadcast	Security Systems	Transportation	Enterprise Networks /Data Centers	FTTx	FTTA	Network Installation	Test Equipment	Production Testing	Imaging	Sensors	
		Aerospace	Defense											Industrial	Telecom	Instrumentation	Medical									
Harsh Series	 LuxCis® ARINC 801 with Circular connector	■	■	■	■	■	■	■	■	■	■	■				■						■	■			
	 LuxCis® ARINC 801 with Disconnect connector	■	■	■	■	■	■	■	■	■	■	■				■							■	■		
	 LuxCis® ARINC 801 with Rack & Panel connector	■				■					■						■						■	■		
	 EB-LuxCis® F746	■		■	■			■	■	■	■						■									
	 EB Contact F730	■		■	■			■	■	■	■						■									
Board to Board Series	 LC F727  SC F728  ST F709	■	■	■	■	■	■	■	■	■	■					■						■	■			
	 LuxCis® ARINC 801 with Board to Board connectors	■	■				■		■																	
Tactical Series	 MT-Cis	■	■				■		■	■																
	 EB Tactical Cable Assemblies F739					■			■	■	■	■				■	■									
Outdoor Series	 LuxCis® ARINC 801 with MIL-DTL-38999	■	■	■	■	■	■	■	■	■	■			■		■										
	 RXF F760 - RXF												■	■	■	■	■	■	■	■						
	 R2CT® R2CT																		■	■	■					
	 OSIS® OSIS												■			■	■	■	■	■	■					
Indoor Series	 OPUS® OPUS											■			■	■	■	■	■	■						
	 LC F727  SC F728  ST F709												■	■	■	■	■	■	■	■	■	■	■	■	■	

Product Finder Guide

Series	Coupling system				Fiber type			Mechanical endurance				Operating temperature	
	Push-pull (or latched)	Screw-in	Bayonet	Depending on multipin connector	Single Mode (9/125µm)	MultiMode (62.5/125µm or 50/125µm)	Large core fiber	100 mating cycles	200 mating cycles	500 mating cycles	3000 mating cycles	-40°C / +85°C	-55°C / +125°C*
 LuxCis® ARINC 801 F725				■	■	■	■			■*			■
 EB Cable Assemblies F739		■			■	■					■	■	
 EB-LuxCis® F746				■	■	■				■*			■
 EB Contact F730				■	■	■				■*			■
 LC F727	■				■	■			■	■		■	■
 SC F728	■				■	■			■			■	■
 ST F709			■		■	■	■			■		■	■
 RXF F760 - RXF		■			■	■				■		■	
 R2CT® R2CT		■	■		■	■		■				■	
 OSIS® OSIS	■				■	■		■				■	
 OPUS OPUS	■				■	■		■				■	

* cable or connector dependent



LuxCis® ARINC 801 Contacts
F725



Contents

Introduction	
A Complete Interconnect Solution	1-2
Markets and Applications	1-3
International Standard Documents Compliance	1-3
Features and Benefits	1-4
Characteristics and Performance	
Optical Characteristics	1-5
Mechanical and Environmental Characteristics	1-5
Product Range	
Optical Contacts	1-6 to 1-7
Adapters	1-8
Accessories and Tools	
Tool Kits	1-9
Master Cords	1-10
Accessories	1-11
LuxCis® ARINC 801 Cable Assemblies	
Radiall Capability	1-12
How to Order: Standard Jumpers for Harsh Environments	1-13
Optical System Capability	1-14

Our Most Important Connection is with You.™

Introduction



Fiber optic solutions constantly face new challenges and more demanding specifications.

- Fiber optic components need to be lighter, smaller, more performant and withstand tougher operational conditions
- Optical systems also need to be easy to implement with minimum maintenance

To fully address these needs, Radiall offers the LuxCis® ARINC 801 product range, a proven flexible and always expanding fiber optic interconnect solution for MultiMode and SingleMode PC and APC applications in aerospace and other harsh environments.



Flying since 2003, the LuxCis® ARINC 801 contact exhibits excellent performance in the most severe environments. Its unique design provides high density capabilities and ease of manipulation, making it the first choice for the ARINC 801 standard and several major companies in various markets.



A COMPLETE INTERCONNECT SOLUTION

The same contact fits all connectors

The LuxCis® ARINC 801 product range combines Radiall expertise in fiber optics and in multipin interconnect solutions.

Refer to Section 2 for interconnect solutions with LuxCis® ARINC 801 contacts.

Introduction

MARKETS AND APPLICATIONS

LuxCis® ARINC 801 has been qualified for military and commercial aerospace programs and is used in many applications in oil and gas, naval, transportation and other industries with harsh environmental requirements.

Examples of applications for LuxCis® ARINC 801 contacts are:

Aerospace



Defense



Industrial



Civil Aerospace

Airframe avionics, IFE (In-Flight Entertainment), HUD (Heads Up Display), power & flight management, pressurized and unpressurized area transmissions

Military Aerospace

Avionics, radar, weapons system, power & flight management

Data Transmissions

High speed data networking, including wavelength multiplexing, broadcast, radio signal

Radars

Remote antennas, phase array radar, military radio networking, satellite

Test Equipment

Modulator, repeater, transceivers, measurement and test equipment in laboratories

Navy & Shipboard

Radar and missile system, communication

Geophysics

Oil & gas, mining, exploration with streamers arrays, roofers and shearing equipment

Sensors

Structural, environmental and airborne sensors

INTERNATIONAL STANDARD DOCUMENTS COMPLIANCE

LuxCis® ARINC 801 design, developed by Radiall, has been used as the basis design for several standards.

The Radiall LuxCis® ARINC 801 interconnect solution is manufactured according to EN/AS/JISQ 9100 and is RoHS compliant. It also complies with the following standards:

ARINC Standard

Radiall solution, based on LuxCis® contact, has been voted as the FO interconnect solution for aerospace applications by the ARINC committee and airlines and is described in the ARINC 801 specification. ARINC 801 describes the contacts and the specific inserts used in MIL-DTL-38999 shells and EPX® connectors.

EN Standard

- EN4639-0XX: describing the LuxCis® inserts for the EN4644 (EPX®) connectors
- EN4639-101: describing the LuxCis® contact
- EN4640: describing the LuxCis® configurations for ARINC 600 connectors
- EN4645: describing the LuxCis® configurations for MIL-DTL-38999 based connectors

SAE Standard

- AS 6250



Introduction

FEATURES AND BENEFITS

High Optical Performance

- Physical contact technology, proven interconnect with high optical performance
- Unique solutions available with APC capability, providing very low Return Loss (RL>65 dB)
- Ruggedized contact to meet harsh environment requirements while maintaining high optical performance

Robust Design

- Metal body
- Crimping on the cable, strengthening members & jacket
- Full pull-proof design on loose structure cables
- Keyed contact for APC applications, provides optimal alignment and prevents rotation

High Density Solution

- Using 1.25 mm ferrule
- Up to 12 LuxCis® ARINC 801 contacts in each EPX® EN4644 insert
- Up to 32 LuxCis® ARINC 801 contacts in MIL-DTL-38999 size 25 circular connector

User-Friendly

- Uses a standard size 16 plastic tool for insertion and extraction
- Dedicated multipin connectors with removable sleeve holder for optimal ease of termini cleaning and inspection process
- Full range of tooling kits available
- Compatible with LC test equipment

Versatile Solution

- Same contact fits in a wide range of connectors with maintained optical performance
- Hermaphroditic: no pin and socket configuration
- Available in MultiMode PC, SingleMode UPC and SingleMode APC
- Compatible with a wide range of cables and fiber types
- Interconnect hybrid solutions
- Hermetic configurations available

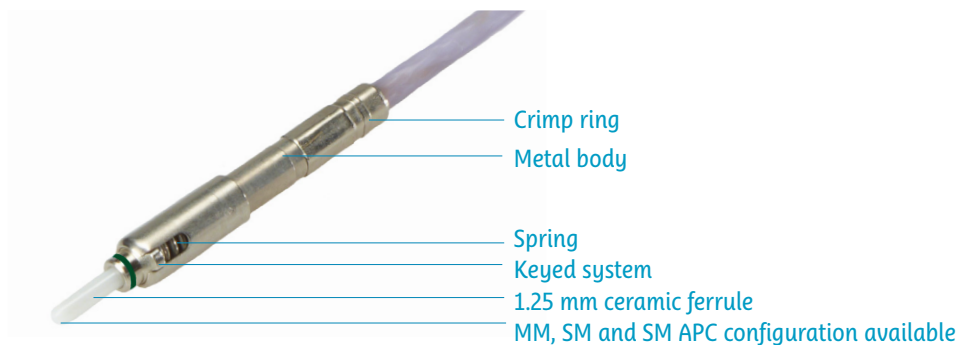

Characteristics and Performance

The LuxCis® contact has been qualified per ARINC 801 and EN standards. Please refer to these documents for detailed information. The LuxCis® ARINC 801 product range has passed many other qualifications, including customer driven qualifications. The values mentioned do not represent maximum achievable results but tested values.

Main results and performance information are in the following tables:

OPTICAL CHARACTERISTICS

	SingleMode UPC	SingleMode APC	MultiMode PC
Wave length	1310-1550 nm		850-1300 nm
Insertion Loss			
Mean	0.15 dB	0.2 dB	0.10 dB
Standard deviation	0.10 dB	0.12 dB	0.07 dB
Return Loss	>50 dB	>65 dB	>20 dB

Insertion Loss against a reference patchcord: IEC 61300-3-4 Method B, also described in ARINC 805

Return Loss: IEC 61300-3-6, also described in ARINC 805

MECHANICAL AND ENVIRONMENTAL CHARACTERISTICS

Test	Standard	LuxCis® in EN4644 (EPX®) Connector	LuxCis® in Mil-DTL-38999 (R8) Connector	LuxCis® in ARINC 600 (NSX) Connector	LuxCis® in LxC-R® Single Channel Connector
Thermal cycling	SAE AS 13441 method 1003.1	-55°C/+125°C (cable dependent)			
Temperature endurance	TIA/EIA 455-4	1000 h @ 125°C (cable dependent)			
Vibration	TIA/EIA 455-11	27 Grms	43 Grms 60 G sinus	16.4 Grms	50 Grms
Shocks	TIA/EIA 455-14	50 G, 11 ms	300 G, 3 ms	50 G, 11 ms	300 G, 3 ms
Durability	TIA/EIA 364-09	100 cycles	500 cycles	500 cycles	500 cycles
Maintenance aging	SAE AS 13441 method 2002.1	10 cycles			
Cable retention 1.8 mm diameter	SAE AS 13441 method 2009.1	68 N			
Cable retention 0.9 mm diameter	SAE AS 13441 method 2009.1	7 N			
Humidity	TIA/EIA 455-5	10 cycles/24 h - 90% RH - -25°C/+65°C			
Salt spray	SAE AS 13441 method 1001.1	96 h	2000 h	48 h	500 h
Altitude immersion	TIA/EIA 455-15A	Minimum pressure equivalent to an altitude of 15,200 m (50,000 ft.).			

For any additional information, please contact your local Radiall representative.

Product Range

OPTICAL CONTACT

The LuxCis® ARINC 801 contact has a variety of different part numbers to accommodate many configurations: SingleMode APC, SingleMode UPC and MultiMode as well as loose and tight structure cables and various cable diameters.

Outside dimensions of the LuxCis® ARINC 801 contact do not change but the internal ones comply with the structure of the cable. Hence the construction of the LuxCis® ARINC 801 contact part number depends on which cable or fiber type is desired.

The structure of a cable is defined per ARINC 802:

Loose structure: A fiber optic cable structure that allows slight movement of the secondary buffer next to the inner strength members and outer cable jacket.

Tight structure: A fiber optic cable structure that allows no movement of the fiber and secondary buffer with respect to the outer jacket.

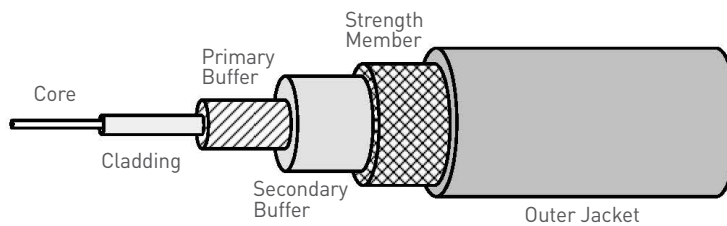

The LuxCis® contact range can accommodate virtually all the cables used for aerospace and military applications (ARINC, SAE, EN, FONDA, MIL). For any additional information, please contact your local Radiall representative.

HOW TO ORDER

F725 0 03 419

F725: ← LuxCis® ARINC 801 series

Ferrule type: ←

- 00:** PC ferrule for 9/125 µm SingleMode fiber
- 03:** PC ferrule for 50/125 or 62.5/125 µm MultiMode fiber
- 04:** PC ferrule for 100/140 µm MultiMode fiber
- 05:** PC ferrule for 200/230 µm MultiMode fiber
- 50:** APC ferrule for 9/125 µm SingleMode fiber

Cable type and diameter: ←

- 118:** 900 µm cable
- 318:** 1.2 mm cable with strengthening members, tight structure
- 419:** 1.6 to 2.2 mm cable, loose structure
- 519:** 1.6 to 2.2 mm cable, tight structure

For instance, to terminate a loose structure cable with a cable diameter size from 1.6 to 2.2 mm for a MM PC application, the part number F725 003 419 is needed.

LuxCis® contact part numbers cross-referenced with ARINC 801 equivalent:

Part Number	ARINC 801 Equivalent
F725 003 419	LM (Loose MultiMode)
F725 000 419	LS (Loose SingleMode)
F725 050 419	LSA (Loose SingleMode APC)
F725 003 519	TM (Tight MultiMode)
F725 000 519	TS (Tight SingleMode)
F725 050 519	TSA (Tight SingleMode APC)

Product Range

OPTICAL CONTACT DIMENSIONS

LuxCis® ARINC 801 contact for loose structure cables: pull-proof

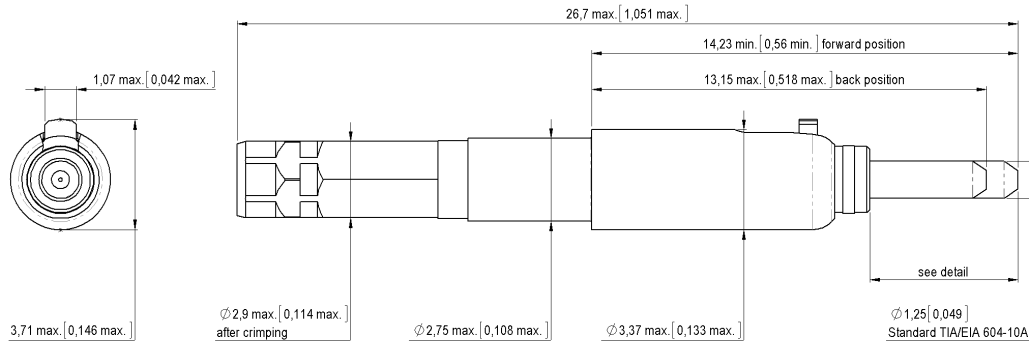

LuxCis® ARINC 801 contact for tight structure cables: not pull-proof

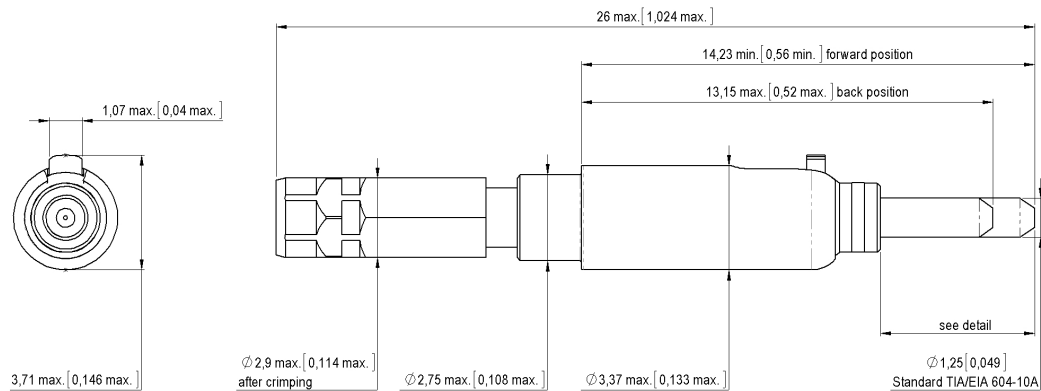

APC LuxCis® ARINC 801 contact

Contact APC

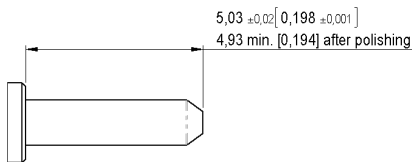

UPC LuxCis® ARINC 801 contact

Contact PC

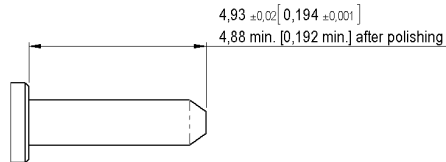

Color code on the contact to facilitate fiber and polishing recognition:



SingleMode APC LuxCis® ARINC 801 contacts feature a green line around the ferrule holder.



SingleMode UPC LuxCis® ARINC 801 contacts feature a blue line around the ferrule holder.







MultiMode LuxCis® ARINC 801 contacts feature no line of color.

LuxCis® ARINC 801

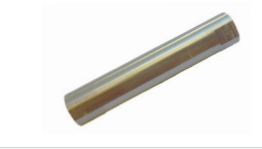

Product Range

ADAPTERS

The following adapters require the use of a standard size 16 M81969/14-03 tool (Radiall PN:282 515) to insert or extract the LuxCis® ARINC 801 contact.

Description	Part Number	
LuxCis® to LuxCis® adapter, simplex bulkhead feedthrough	F725 701 100	
LuxCis® to LuxCis® adapter, simplex straight	F725 700 100	
LuxCis® to LuxCis® adapter, duplex, for PCB	F725 745 000	
LuxCis® to LC adapter, simplex, LC panel cut-out	F719 060 000	
LuxCis® to LC adapter, duplex, LC panel cut-out	F719 058 010	
LuxCis® to LC adapter, duplex, MIL-DTL-38999 panel cut-out	F719 058 000	

Quick release adapters do not require the use of any tool. This feature makes them ideal for measurements and tests in laboratories.

Description	Part Number	
LuxCis® to LuxCis® adapter, quick release	F780 799 001	
LuxCis® to LC adapter, quick release	F780 799 000	

All LuxCis® ARINC 801 adapters use zirconia ceramic alignment sleeves. Their mechanical endurance is up to 200 mating cycles.

Accessories and Tools

TOOL KITS



To support customers in maintenance and manipulation of optical systems, Radiall offers a full range of kits, tools and accessories.

The LuxCis® ARINC 801 tool kits provide efficient, easy and reliable fiber optic inspection, cleaning, termination and polishing. Radiall's tool kits feature high quality tools and materials, state-of-the-art devices and detailed procedures.

Termination and Polishing Kits

Part Number	Description
F780 861 000	Termination kit (with 220 Volt curing oven)
F780 862 000	Termination kit (with 110 Volt curing oven)
F780 860 000	Polishing kit (with mechanical polisher)



Termination kit
F780 861 000 or F780 862 000



Polishing kit
F780 860 000

Inspection and Cleaning Kits

Part Number	Description
F780 538 000	PREMIUM Inspection & Cleaning kit (with handheld video display)
F780 539 000	Inspection & Cleaning kit (without handheld video display)
F780 541 000	Cleaning supplies kit (for Inspection & Cleaning kit replenishment)



PREMIUM Inspection &
Cleaning kit
F780 538 000

Note: Radiall also supplies effective test solutions to measure Insertion Loss, Return Loss and end face geometry of LuxCis® ARINC 801 fiber optic contacts.

Refer to Section 11, Tool Kits and Accessories, for more information on Radiall's tooling offers.

Please note photos shown serve only as a reference and actual product may vary.

Accessories and Tools

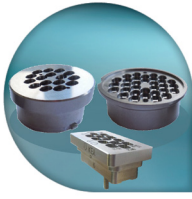

Inspection Assistant Kits

To support and ease the inspection and cleaning process, Radiall has developed dedicated devices enabling trouble-free maintenance of LuxCis® ARINC 801 contacts inside multipin connectors: EPX® EN4644 and R8 MIL-DTL-38999.

With the inspection assistant guides, there is no need to take extra precaution when inspecting and cleaning the optical end face. This device can be used with the microscope probe included in the Radiall Inspection & Cleaning kit (F780 538 000 and F780 539 000).

In MIL-DTL-38999 type connectors:



In EPX EN4644 connectors:

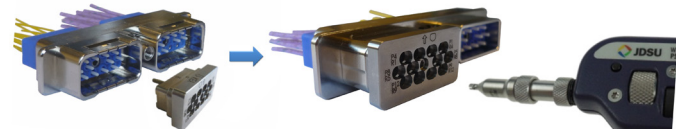

Key features:

- Optimized inspection and cleaning process
- No extra manipulation: guide cavities designed to permit the cleaning of the optical end face without removing the guide
- Ease of handling
- Adapted to PC, UPC and APC LuxCis® ARINC 801 fiber optic contacts
- Available for EPX® EN4644 and MIL-DTL-38999 type connectors

Assistant inspection guides are available in a complete kit or as individual items.

Series	Description	Part Number
Inspection assistant for LuxCis® inside R8 MIL-DTL-38999 type connectors	Full kit: - Guides for R8 plugs and receptacles from size 11 to 25 - Dedicated tips for microscope probe (F780 725 000 ⁽²⁾ for APC and F780 725 001 ⁽²⁾ for PC) - Cleaning sticks to clean the guide cavities	F780 725 200
	Individual guide for plug size X ⁽¹⁾	F780 725 0XX ⁽¹⁾
	Individual guide for receptacle size X ⁽¹⁾	F780 725 1XX ⁽¹⁾
Inspection assistant for LuxCis® inside EPX® EN4644 connectors	Individual guide for EPXB plug and receptacle	F780 725 300
Tips for digital microscope probe	Tips for PC polishing	F780 725 001 ⁽²⁾
	Tips for APC polishing	F780 725 000 ⁽²⁾
	Angled tip for inspection of PC termini in hard-to-reach areas	F780 898 001 ⁽²⁾

⁽¹⁾Replace X by the size (from 11 to 25) of the connector you wish to inspect and clean.

⁽²⁾Tips to be assembled with the narrow long type barrel (F780 898 000) to be attached on the microscope probe

Accessories and Tools

MASTER CORDS

Radiall offers a broad range of high performance Master Cords, also known as Gold cables or Aerospace Measurement Quality Jumpers (AMQJ) as defined in ARINC 805. They are manufactured and tested using the latest measurement processes and standards. Used to accurately measure optical properties of optical systems, they offer very low optical losses.

The end face control processes, including geometry and concentricity tests, meet the criteria per the latest version of Telcordia GR-326-CORE. Radiall's Master Cords also comply with ARINC 805, TIA/EIA-455-171A, CEI 60874-14-1 and CEI 61754-4 specifications.



LuxCis® ARINC 801 Master Cords are available in various configurations and can be terminated with the following extremities: LC, SC, ABS1379, FC.

Refer to Section 11, Tool Kits and Accessories, to see the list of available part numbers.

ACCESSORIES

Description	Packaging	Part Number	
Plastic insertion/extraction tool, size 16 (M81969/14-03)	1 piece	282 515	
Dynamometric screwdriver for sleeve holder removal and installation	1 piece	F780 638 000	
1 bag of 10 dust caps for LuxCis® ARINC 801	1 bag of 10 pieces	F718 176 104	
1 bag of 100 dust caps for LuxCis® ARINC 801	1 bag of 100 pieces	F718 176 204	
1 bag of 100 sealing plugs for LuxCis® ARINC 801 cavities	1 bag of 100 pieces	F718 211 200	

F718 211 200: LuxCis® ARINC 801 Sealing Plugs:

Sealing plugs are specifically designed to fill the unused ARINC 801 cavities of multipin connectors such as EPX® EN4644, QM, NSX ARINC 600, MIL-DTL-38999 and others.

- Mimic the shape of a terminated LuxCis® ARINC 801 contact
- High temperature and fluid resistant
- Ergonomic design for easy insertion and extraction



Refer to Section 11, Tool Kits and Accessories, for more information on Radiall's tooling offers.

LuxCis® ARINC 801 Cable Assemblies

RADIALL CAPABILITY

With over 40 years of fiber optic experience, Radiall is a global leader in the design and development of high quality harnesses and complex optical systems for demanding applications. All products are manufactured in AS9100 certified assembly lines. Each cable assembly is visually inspected and tested per the criteria of the relevant industry standards (ARINC, EN, SAE, IEC).

Radiall can provide either standard cable assemblies or build-to-print configurations.

- Standard cable assemblies (also called Standard Jumpers) enable high reactivity and short lead time due to the direct availability of components and established manufacturing processes.
- With the build-to-print solution, Radiall complies with customer requirements, offering flexible designs and manufacturing processes to build assemblies to customers' exact specifications.

Flexible assembly processes enable Radiall to respond to low to high volume requirements.

Radiall offers various polished and tested assemblies, with commercial and harsh environment components including:

Cables:

- Aerospace grade cable, loose structure, type ARINC 802, BMS 13-71, temperature range (-55°/+125°C)
- Aerospace grade cable, tight structure, type ARINC 802, ABS0963, temperature range (-55°/+125°C)
- Commercial grade cable "not for flight" for ground test applications
- MIL cable
- Ruggedized, armored and anti-rodent telecom cable for outdoor applications
- Loose, tight and ultra tight structure cables
- Simplex, scindex and duplex cables

Connectors:

- LuxCis® ARINC 801 contacts
- LC, SC, ST, FC ruggedized connectors
- Radiall ABS1379 contacts
- Size 12 and 16 MIL-PRF-29504 type termini
- MT based connectors

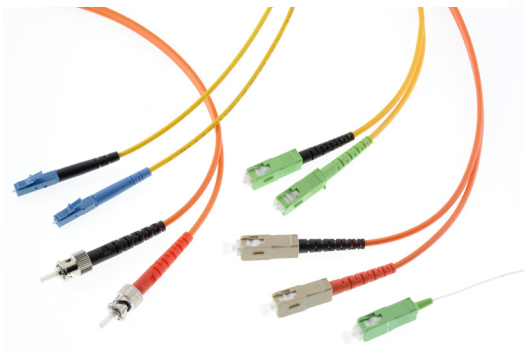

LuxCis® ARINC 801 Assemblies

HOW TO ORDER: STANDARD JUMPERS FOR HARSH ENVIRONMENTS

Radiall designs, manufactures and delivers high quality cable assemblies. They are manufactured in AS9100 certified assembly lines. The cable assemblies are visually inspected and tested per the criteria of the relevant industry standards (ARINC, EN, SAE, IEC).

LUXCISMM 52 LCMM L100

End 1:

LUXCISMM	LuxCis®	MultiMode	
LUXCISSM	LuxCis®	SingleMode	UPC (RL>50dB)
LUXCISSM8	LuxCis®	SingleMode	APC 8° (RL>65dB)
LCMM	LC	MultiMode	
LCSM	LC	SingleMode	UPC (RL>50dB)
LCSM8	LC	SingleMode	APC 8° (RL>65dB)
SCMM	SC	MultiMode	
SCSM	SC	SingleMode	UPC (RL>50dB)
SCSM8	SC	SingleMode	APC 8° (RL>65dB)
FCMM	FC	MultiMode	
FCSM	FC	SingleMode	UPC (RL>50dB)
FCSM8	FC	SingleMode	APC 8° (RL>65dB)
STMM	ST	MultiMode	
STSM	ST	SingleMode	UPC (RL>50dB)
ABS1379MM	ABS1379	MultiMode	

Cable:

14	900 µm	MM 62.5/125 µm	loose	Simplex	aerospace grade
15	900 µm	MM 62.5/125 µm	tight	Simplex	aerospace grade
16	900 µm	MM 50/125 µm	loose	Simplex	aerospace grade
13	900 µm	MM 62.5/125 µm	loose	Simplex	commercial grade
11	900 µm	MM 62.5/125 µm	tight	Simplex	commercial grade
10	900 µm	MM 50/125 µm	tight	Simplex	commercial grade
60	900 µm	SM 9/125 µm	tight	Simplex	commercial grade
52	1.8-2 mm	MM 62.5/125 µm	loose	Simplex	aerospace grade
52D	1.8-2 mm	MM 62.5/125 µm	loose	Duplex	aerospace grade
53	1.8-2 mm	MM 62.5/125 µm	tight	Simplex	aerospace grade
55	1.8-2 mm	MM 50/125 µm	loose	Simplex	aerospace grade
78	1.8-2 mm	MM 50/125 µm	tight	Simplex	aerospace grade
92	1.8-2 mm	SM 9/125 µm	loose	Simplex	aerospace grade
23	1.8-2 mm	MM 62.5/125	loose	Simplex	commercial grade
40	1.8-2 mm	MM 62.5/125 µm	loose	Scindex	commercial grade
27	1.8-2 mm	MM 50/125 µm	loose	Simplex	commercial grade
39	1.8-2 mm	MM 50/125 µm	loose	Scindex	commercial grade
73	1.8-2 mm	SM 9/125 µm	loose	Simplex	commercial grade
77	1.8-2 mm	SM 9/125 µm	loose	Scindex	commercial grade

End 2:

See End 1

X no termination

Length of the cable in centimeters

Standard length tolerance in centimeters	
from 12 to 100 cm	0/+2.4 cm
from 100 to 1500 cm	0/+3.4 cm
from 1500 to 3000 cm	0/+4.4 cm
from 3000 to 5000 cm	0/+17.4 cm

To validate a part number please consult your Radiall representative. Technical datasheets are available upon request. Specific requirements (additional tests, specific labeling and additional protection of the cable) or any other cable assembly configuration can be accommodated on demand.

Our Most Important Connection is with You.™

LuxCis® ARINC 801 Assemblies

OPTICAL SYSTEM CAPABILITY

Radiall's design and manufacturing expertise, together with its wide interconnect product offering, enable Radiall to meet customers' needs for custom harness solutions.

Available to provide support for optical links requiring excellent performance and ease of installation, as well as develop application specific accessories or interconnect solutions when required.

Radiall is able to support a wide range of requirements, from simple contact and connector solutions to the most complex fiber optic based harnesses or sub systems for harsh environments.



Refer to Section 9 for more information on Radiall's optical systems, harnesses and cable assembly capabilities. For any additional information, please contact your local Radiall representative.



LuxCis® ARINC 801 Interconnect Solutions

*EPX® EN4644, QM, NSX ARINC 600,
R8 MIL-DTL-38999, LxC-R®*



Contents

Introduction	
A Complete Interconnect Solution	2-2
Markets and Applications	2-2
Range Overview	2-3
EPX® EN4644 and QM Quick Multipin	
EPX® EN4644	2-4
QM Quick Multipin	2-5
Mechanical and Environmental Characteristics	2-6
Inserts Arrangements for LuxCis® ARINC 801 Contact	2-6 to 2-8
How to Order Inserts	2-9
NSX ARINC 600	
Standards	2-10
Features and Benefits	2-10
Mechanical and Environmental Characteristics	2-10
Inserts Arrangements	2-10
How to Order Inserts	2-11
QUADRAX Adapters for LuxCis® ARINC 801 Contacts	2-12
R8 Series: MIL-DTL-38999 Type	
Standards	2-13
Features and Benefits	2-13
Mechanical and Environmental Characteristics	2-14
Shell Dimensions	2-14
Inserts Arrangements	2-15 to 2-16
How to Order R8 Connectors	2-17
R9 Series: Hermetic MIL-DTL-38999 Type	
Applications	2-18
Standards	2-18
Features and Benefits	2-18
Product Range	2-18
Mechanical and Environmental Characteristics	2-19
Shell Dimensions	2-19
LxC-R® Series: Single Channel	
Standards	2-20
Features and Benefits	2-20
Mechanical and Environmental Characteristics	2-21
Shell Dimensions	2-21
How to Order LxC-R® Connectors	2-22
Custom Design Connectors	2-23
Harnesses and Optical System Capability	2-23

Introduction

A COMPLETE INTERCONNECT SOLUTION

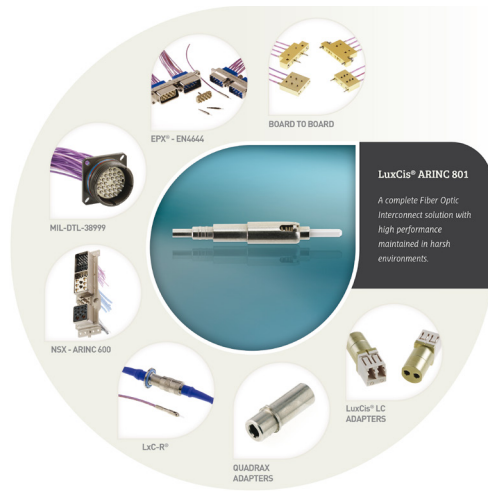

Radiall is recognized in the aerospace and defense industries for offering one of the broadest innovative product portfolios for interconnect solutions. The benefit of Radiall's experience with ARINC connectors and the high quality of the LuxCis® ARINC 801 contact enable Radiall to provide customers with strong and global solutions.

The combination of Radiall multipin connectors and LuxCis® ARINC 801 fiber optic contacts is the optimal solution for high and consistent performances in harsh environments.

MARKETS AND APPLICATIONS



Civil Aerospace

Airframe avionics, IFE (In-Flight Entertainment), HUD (Heads Up Display), power & flight management, pressurized and unpressurized area transmissions

Military Aerospace

Avionics, radar, weapons system, power & flight management

Data Transmissions

High speed data networking, including wavelength multiplexing, broadcast, radio signal

Radars

Remote antennas, phase array radar, military radio networking, satellite

Test Equipment

Modulator, repeater, transceivers, RF splitters and switches, measurement and test equipment in laboratories

Navy & Shipboard

Radar and missile system, communication

Geophysics

Oil & gas, mining, exploration with streamers arrays, roofers and shearing equipment

Sensors

Structural, environmental and airborne sensors

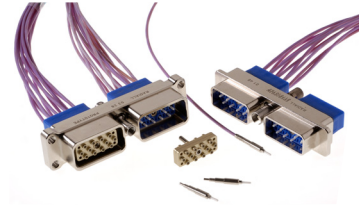

Photo courtesy of CEA Technologies

Introduction

RANGE OVERVIEW

Rectangular Connectors:



EPX® EN4644

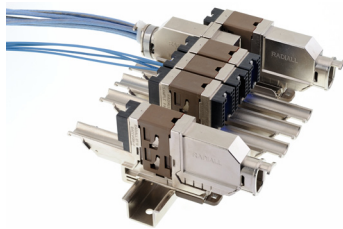

QM Quick Multipin



NSX ARINC 600

Circular Connectors:



R8 MIL-DTL-38999 type

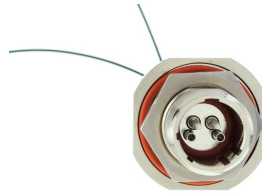

R9 Hermetic MIL-DTL-38999 type



LxC-R® single channel

Custom Design Connectors:

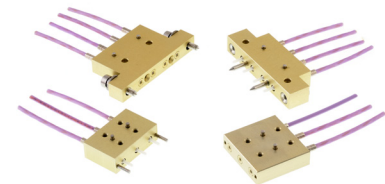

Board to board and custom design

Harnesses and Optical System Capability



Refer to the multipin catalog for more information on Radiall's wide multipin connector range.

EPX® EN4644 and QM Quick Multipin



EPX® EN4644 SERIES FOR LUXCIS® ARINC 801 CONTACTS

The EPX® EN4644 series offers a wide range of solutions based on two insert sizes with a large variety of shells, contacts and configurations. This product range provides an excellent trade-off between the number of available contacts and the space used. The EPX® series is completely modular and expandable.

STANDARDS

- RoHS compliant
- Compliant with EN4644 standard



FEATURES AND BENEFITS

- Designed and qualified for PC, UPC and APC (Angle Physical Contact) termination
- Optimized alignment of fiber optic contacts

High Density Solution

- Slim shell design with high contact density
- Higher density compared to circular MIL-spec connectors

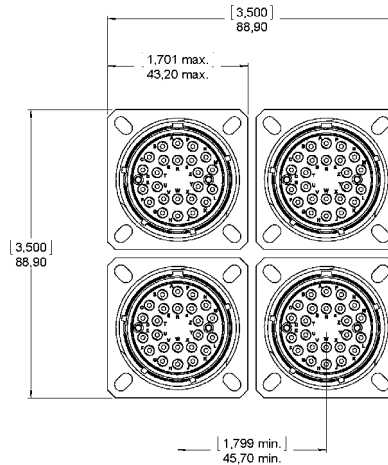
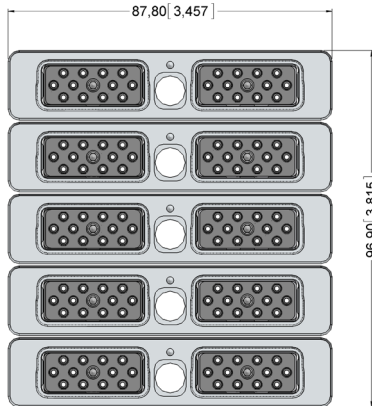

EPXB:

- 5 shells #2 with 2*12 LuxCis® ARINC 801 contacts
- Number of contacts: 120
- Total surface: 96.90 x 87.80 = 8507.82 mm²
- => Gives 70.90 mm²/contact

MIL-DTL-38999:

- 4 shells #23 with 24 LuxCis® ARINC 801 contacts
- Number of contacts: 96
- Total surface: 88.90 x 88.90 = 7903.21 mm²
- => Gives 82.32 mm²/contact

Cost Saving & Convenient Solution

- Inserts can be easily installed and removed from the shell
- Inserts and shells are keyed to prevent mis-mating
- Standard MIL spec tools for contact crimping and contact insertion/extraction
- Vibration resistant self-locking threads
- Various options available to withstand harsh environments

Modular Concept

- Shell can accommodate a large variety of inserts for signal, power, coax, data bus, fiber optic and high frequency BMA contacts, providing various hybrid configurations
- EPX® inserts can also be used in the Radiall QM connectors
- Easy inspection, cleaning and manipulation of fiber optic contacts

EPX® EN4644 and QM Quick Multipin

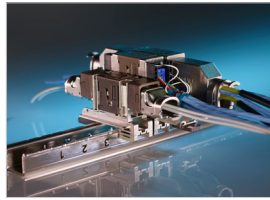

QM QUICK MULTIPIN SERIES FOR LUXCIS® ARINC 801 CONTACTS

A modular and tool less connector

Radiall QM connectors are designed for use with in-line disconnect applications on commercial airplanes. Radiall QM series offers outstanding performances and is designed with environmental and mechanical characteristics that provide long lasting durability needed for the most severe aerospace applications.

Two connector sizes are available in the QM series to optimize disconnect applications in terms of weight and density in an aircraft wiring system.

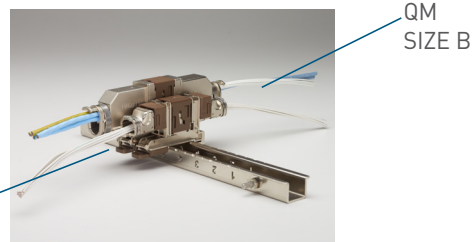

STANDARDS

- RoHS compliant



FEATURES AND BENEFITS

Using EPX® inserts, the QM series offers a wide array of arrangements that covers all contact technologies. It is manufactured under US patent App. No 11/614.642 and is available worldwide.

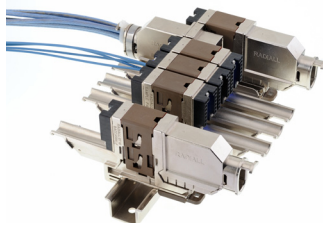

- Designed and qualified for APC (Angle Physical Contact) termination
- Optimized alignment of fiber optic contacts
- High conductive rails
- Save weight with composite connector
- Simplify the wiring design as no panel cut-out is needed
- Save time during wiring with a tool less connector

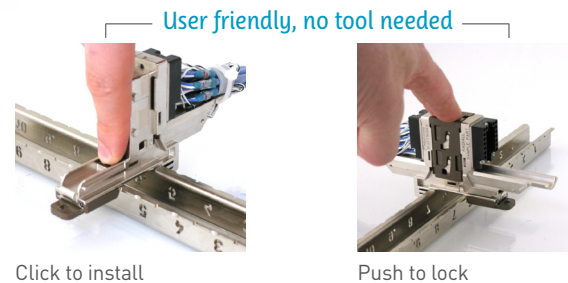

MECHANICAL AND ENVIRONMENTAL CHARACTERISTICS

Test	Standard	LuxCis® in EPX® EN4644 connectors	LuxCis® in QM connectors
Thermal cycling	SAE AS 13441 method 1003.1	-55°C/+125°C (cable dependent)	-55°C/+125°C (cable dependent)
Temperature endurance	TIA/EIA 455-4	1000 h @ 125°C (cable dependent)	1000 h @ 125°C (cable dependent)
Vibration	TIA/EIA 455-11	27 Grms	27 Grms
Shocks	TIA/EIA 455-14	50 G, 11 ms	50 G, 11 ms
Durability (mating/unmating)	TIA/EIA 364-09	100 cycles	50 cycles
Maintenance aging (Insertion/extraction)	SAE AS 13441 method 2002.1	10 cycles	10 cycles
Cable retention 1.88 mm diameter	SAE AS 13441 method 2009.1	68 N	68 N
Cable retention 0.9 mm diameter	SAE AS 13441 method 2009.1	7 N	7 N
Humidity	TIA EIA 455-5	10 cycles/24 h; 90% RH; -25°C/+65°C	10 cycles/24 h; 90% RH; -25°C/+65°C
Salt spray	SAE AS 13441 method 1001.1	96 h	96 h

Note: The LuxCis® ARINC 801 product range has passed many qualifications, including customer driven qualifications. Not all the tests performed on LuxCis® ARINC 801 products are described in the table above. Request for information on a test not mentioned in the table or harsher conditions shall be addressed to your local Radiall representative.

Our Most Important Connection is with You.™

EPX® EN4644 and QM Quick Multipin

INSERTS ARRANGEMENTS FOR LUXCIS® ARINC 801 CONTACT

Full size inserts arrangements are compliant with EN4644. Two sizes of inserts are available:

- EPXA inserts are size A
- EPXB inserts are size B

EPXA inserts fit in any QM size A connector

QM size A connector

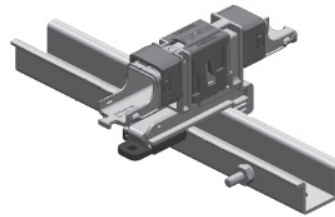

EPXB inserts fit in any EPXB and QM size B connector

QM Size B connector

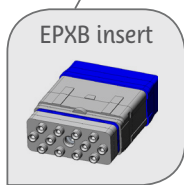
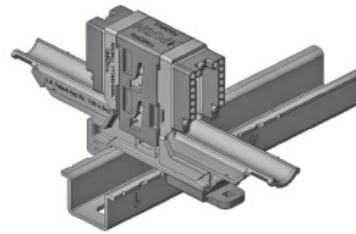

EPXB connectors for disconnect applications



EPXB1



EPXB2

EPXB connectors for rack & panel applications



EPXB1



EPXB2



EPXB3



EPXB4

EPX® EN4644 and QM Quick Multipin

ENVIRONMENTAL INSERTS

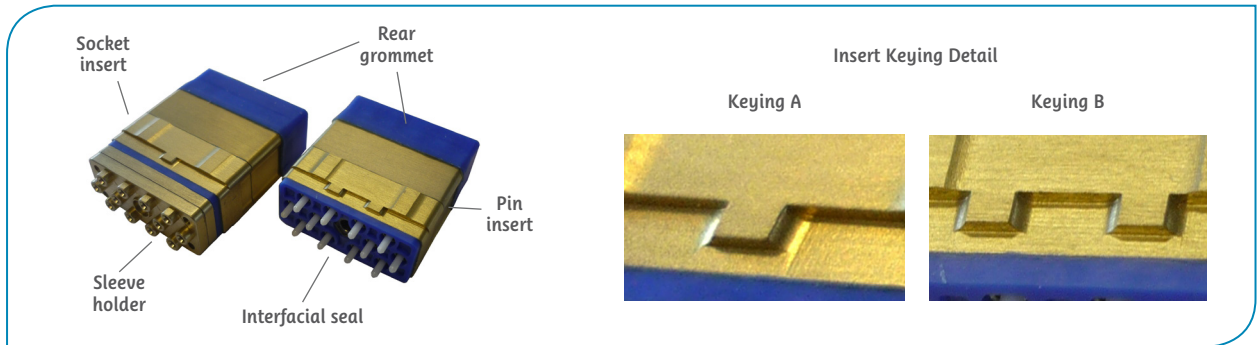

Notes: Inserts are designed for rear release and rear removable contacts.
Pin and socket inserts can be pre-installed in either plug or receptacle shells.

- For EPXB1, EPXB3 and EPXB4 shells, use only insert keyed A
- For EPXB2 shells, use one insert keyed A and one insert keyed B
- For QM size A and B connector, use only insert keyed A

HYBRID INSERTS

Due to specifically designed inserts, EPX® EN4644 and QM connectors enable the combination of LuxCis® ARINC 801 contacts and electrical contacts in the same shell cavity.

LuxCis® ARINC 801 fiber optic contacts

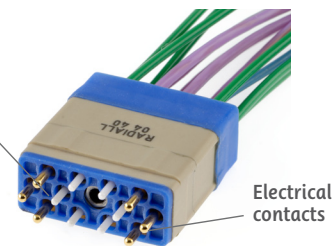

Electrical contacts

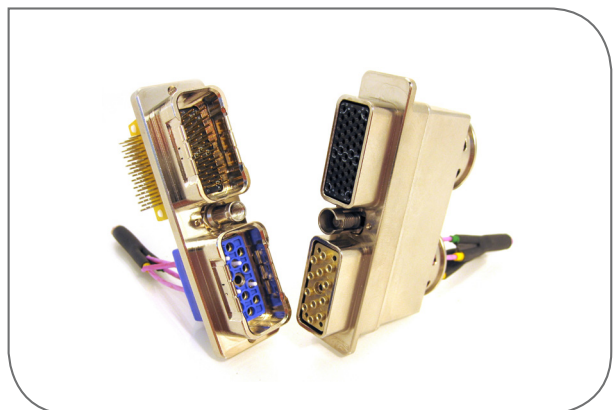
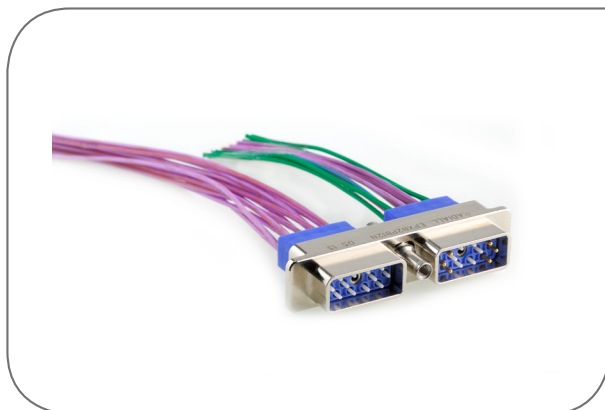

EPX® EN4644 and QM Quick Multipin

HOW TO ORDER INSERTS

LuxCis® ARINC 801 in EPX® and QM connectors requires standard EPX® or QM shells and dedicated LuxCis® ARINC 801 inserts.

Available part numbers for inserts to be mounted inside QM size A connectors:

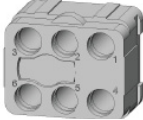
Insert Arrangement	Insert Type	Part Number
Insert F6: Full optic 6 LuxCis® ARINC 801 contacts 	Pin Inserts	EPXAEF6PA
	Socket Inserts	EPXAEF6SA

Available part numbers for inserts to be mounted inside EPXB or QM size B connectors:

	Insert Arrangement	Insert Type	Part Number for Keying A	Part Number for Keying B
	Insert F12C: full optic 12 LuxCis® ARINC 801 contacts	Pin insert		EPXBEB12CPA
Socket insert			EPXBEB12CSA	EPXBEB12CSB
Insert 12F6: hybrid 6 LuxCis® ARINC 801 contacts and 6 electrical contacts	Pin insert		EPXBE12F6PA	EPXBE12F6PB
	Socket insert		EPXBE12F6SA	EPXBE12F6SB

Notes: Socket inserts are always supplied with a sleeve holder.

Pin inserts are not provided with sleeve holders.

Pin and socket inserts can be pre-installed in plug or receptacle shells.

All fiber optic inserts are also described in the ARINC 801 or EN4639 documents.

For more information on EPX® and QM connectors please refer to the latest version of the multipin catalog.

NSX ARINC 600



NSX ARINC 600 CONNECTORS FOR LUXCIS® ARINC 801 CONTACTS

Radiall's NSX ARINC 600 rack and panel connectors have been entrusted by the major aircraft manufacturers for many decades.

Used to connect high performance equipment in the aircraft's avionics bay, it features multiple LuxCis® ARINC 801 specific inserts, along with solutions to allow turning existing Quadrax cavities into LuxCis® ARINC 801 fiber optic cavities.

STANDARDS

- RoHS compliant
- Compliant with ARINC 600 standard



FEATURES AND BENEFITS

- Optimized alignment of fiber optic contacts
- High contact density
- Wide range of contact types and arrangements, including hybrid insert configurations
- Numerous shell polarization possibilities which give maximum security when mating the equipment in the rack
- Low mating forces
- EMI/RFI shielding option provided by shell to shell conductivity
- Convenient adapters that turn Quadrax cavities into LuxCis® ARINC 801 cavities to allow an easy evolution of electrical to optical

MECHANICAL AND ENVIRONMENTAL CHARACTERISTICS

Test	Standard	LuxCis® in NSX ARINC 600 Connectors
Thermal cycling	SAE AS 13441 method 1003.1	-55°C/+125°C (cable dependent)
Temperature endurance	TIA/EIA 455-4	1000 h @ 125°C (cable dependent)
Vibration	TIA/EIA 455-11	16.4 Grms
Shocks	TIA/EIA 455-14	50 G, 11 ms
Durability	TIA/EIA 364-09	500 cycles
Maintenance aging	SAE AS 13441 method 2002.1	10 cycles
Cable retention 1.88 mm diameter	SAE AS 13441 method 2009.1	68 N
Cable retention 0.9 mm diameter	SAE AS 13441 method 2009.1	7 N
Humidity	TIA/EIA 455-5	10 cycles/24 h; 90% RH; -25°C/+65°C
Salt spray	SAE AS 13441 method 1001.1	48 h

Note: The LuxCis® ARINC 801 product range has passed many qualifications, including customer driven qualifications. Not all the tests performed on LuxCis® ARINC 801 products are described in the table above. Request for information on a test not mentioned in the table or harsher conditions shall be addressed to your local Radiall representative.

NSX ARINC 600

INSERTS ARRANGEMENTS

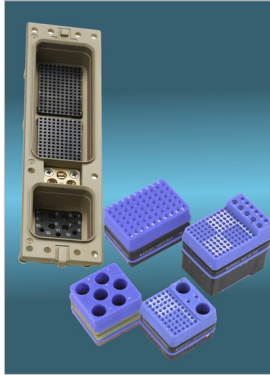

With more than 40 inserts available, 3 plating possibilities and a large number of accessories and options, Radiall's NSX range offers the widest choice of ARINC 600 connector configurations on the market to answer all types of requirements. Available for sizes 1 to 3, it features Environmental and Non-Environmental versions for rear and front removable contacts.

Offering from size 1 to size 22 crimp or PC tailed contacts - including signal, coax, triax and Quadrax - the NSX range allows mixing of fiber optic and signal channels within the same connector.

The NSX product range includes specific inserts that can accommodate up to 36 LuxCis® ARINC 801 contacts per cavity. Quadrax inserts can also accommodate LuxCis® ARINC 801 fiber optic contacts with a specific adapter in order to address a wide array of distinct needs.

HOW TO ORDER INSERTS

Insert Name	Shell Size	Cavity	Number of LuxCis® Contacts	Number of Quadrax Contacts	Other Contacts	Picture
12F5C2	2 or 3	C	5	-	1 contact #16 4 contacts #12 2 contacts #5	
12F12	1	C	12	-	-	
17F12Q2	2 or 3	C	12	2	3 contacts #16	
20F12Qw8	2 or 3	A or B	12	8	-	
62F12	2 or 3	C	12	-	50 contacts #22	
36F36	2 or 3	A or B	36	-	-	

Notes: The sleeve holder is delivered already installed on the insert on the receptacle side.

For more information on NSX ARINC 600 inserts please refer to the latest version of the multipin catalog.

NSX ARINC 600





QUADRAX ADAPTERS FOR LUXCIS® ARINC 801 CONTACTS

Adapters for NSX ARINC 600 connectors' cavities allow evolution of existing connectors. Now, a high speed connection with a connector that used to be equipped with Quadrax contacts is available. Quadrax/LuxCis® adapters will turn a size 8 Quadrax cavity into a LuxCis® ARINC 801 cavity. This solution offers the following characteristics:

- Compliant with any ARINC 600 and Quadrax cavity
- Compatible with ML and MT LuxCis® ARINC 801 designs
- Compatible with Quadrax insertion and extraction tool
- Available for MultiMode applications

HOW TO ORDER QUADRAX/LUXCIS® ADAPTERS

Description	Part Number	Picture
Pin Quadrax adapter for LuxCis® contact in Quadrax FR type cavity with sleeveholder	620 946 001	
Pin Quadrax adapter for LuxCis® contact in Quadrax RR type cavity with sleeveholder	620 946 002	
Socket Quadrax adapter for LuxCis® contact in Quadrax RR type cavity	620 946 003	
Sleeve holder for pin Quadrax adapter	620 946 004	

TOOLS

Part Number	Description
F780 858 000	Key for Quadrax sleeve holder removal
282 549 001	Extraction tool for Quadrax adapter; RR type (MIL-PRF-81969/28-03)
282 549 009	Extraction tool for Quadrax adapter FR type

RR: Rear Release

FR: Front Release

R8 Series: MIL-DTL-38999 Type



MIL-DTL-38999 TYPE CONNECTORS FOR LUXCIS® ARINC 801 CONTACTS

Radiall MIL-DTL-38999 for LuxCis® ARINC 801 fiber optic contact is a multi-channel connector that complies with the ARINC 801 specifications and 38999 Series III standards for the shells. This connector is available in various configurations, sizes and materials to deliver high performance in harsh environments.

Radiall MIL-DTL-38999 connector is a fiber optic solution for all defense and aerospace applications.

STANDARDS

- RoHS compliant (except for Aluminum olive drab cadmium finish)
- Compliant with ARINC 801 specifications
- Compliant with EN4645 standard



FEATURES AND BENEFITS

- Designed and qualified for PC, UPC and APC (Angled Physical Contact) termination
- Three stages of alignment:
 - Shell-to-shell keys
 - Alignment pins
 - Ceramic alignment sleeves
- Shell and locking mechanism compliant to MIL-DTL-38999 Series III standard:
 - Scoop-proof
 - Self-locking
 - Threaded coupling
- Rear grommet for direct sealing on the cable
- High contact density layouts available
- Wide range of accessories available to withstand harsh environments (backshells, protective caps, etc.)
- Hybrid versions
- Hermetic versions
- Easy inspection, cleaning and manipulation of fiber optic contacts with removable sleeve holders
- EMI shielding capability, with anodized aluminum

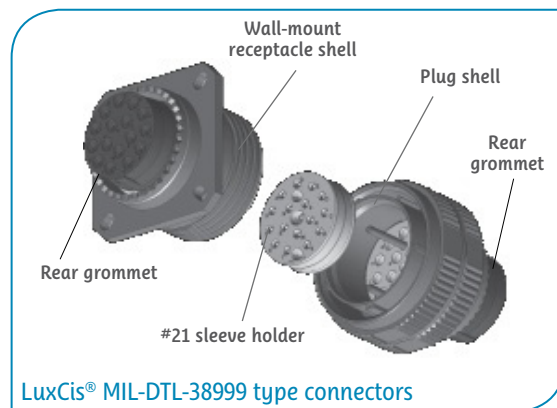

R8 Series: MIL-DTL-38999 Type

MECHANICAL AND ENVIRONMENTAL CHARACTERISTICS

Test	Standard	LuxCis® in R8 MIL-DTL-38999 Connectors
Thermal cycling	SAE AS 13441 method 1003.1	-55°C/+125°C (cable dependent)
Temperature endurance	TIA/EIA 455-4	1000 h @ 125°C (cable dependent)
Vibration	TIA/EIA 455-11	43 Grms 60 G sinus
Shocks	TIA/EIA 455-14	300 G, 3 ms
Durability	TIA/EIA	500 cycles
Maintenance aging	SAE AS 13441 method 2002.1	10 cycles
Cable retention 1.88 mm diameter	SAE AS 13441 method 2009.1	68 N
Cable retention 0.9 mm diameter	SAE AS 13441 method 2009.1	7 N
Humidity	TIA/EIA 455-5	10 cycles/24 h; 90% RH; -25°C/+65°C
Salt spray	SAE AS 13441 method 1001.1	2000 h

Note: The LuxCis® ARINC 801 product range has passed many qualifications, including customer driven qualifications. Not all the tests performed on LuxCis® ARINC 801 products are described in the table above. Request for information on a test not mentioned in the table or harsher conditions shall be addressed to your local Radiall representative.

SHELL DIMENSIONS

Square Flange and Jam Nut Receptacle Dimensions

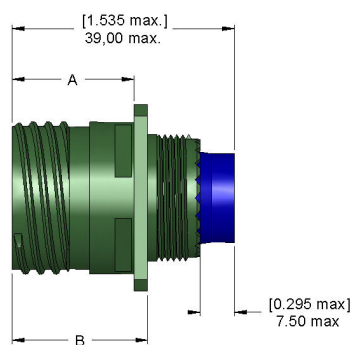

Fig. 1 Square flange receptacle

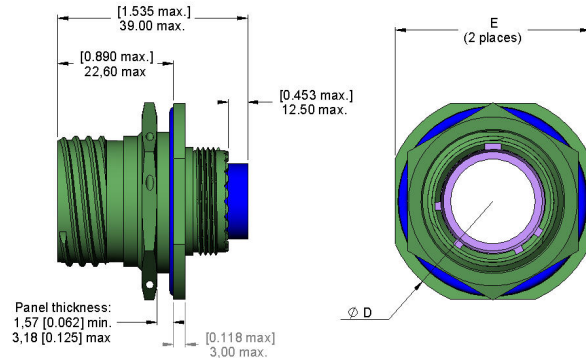
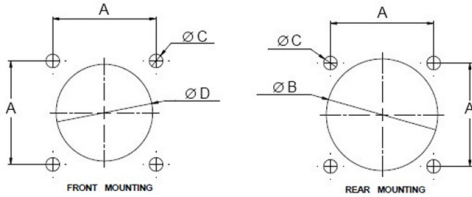

Fig. 2 Jam nut receptacles

Shell Size	Figure 1				Figure 2		
	A max. mm (inch)		B max. mm (inch)		C max. mm (inch)	Dia. D max. mm (inch)	E max. mm (inch)
	Metallic Shell	Composite Shell	Metallic Shell	Composite Shell			
11	20.83 [0.820]	19.69 [0.775]	23.15 [0.911]	23.19 [0.913]	26.50 [1.043]	35.20 [1.386]	32.20 [1.268]
13					28.90 [1.137]	38.40 [1.512]	35.30 [1.390]
15					31.30 [1.232]	41.60 [1.638]	38.50 [1.516]
17					33.70 [1.323]	44.80 [1.764]	41.70 [1.642]
19					36.90 [1.449]	49.50 [1.949]	46.40 [1.827]
21	20.07 [0.790]	18.92 [0.745]	23.14 [0.911]	23.14 [0.911]	40.10 [1.575]	52.70 [2.075]	49.60 [1.953]
23					43.30 [1.701]	55.90 [2.200]	52.80 [2.079]
24					46.40 [1.823]	59.00 [2.323]	56.00 [2.205]
25							

R8 Series: MIL-DTL-38999 Type

Panel Cut-Out Dimensions Square Flange Receptacle



Shell Size	A max. mm (inch)	Dia. B max. mm (inch)	Dia. C max. mm (inch)	Dia. D max. mm (inch)
11	20.62 [0.812]	20.22 [0.796]	3.12 [0.123]	18.26 [0.719]
13	23.01 [0.906]	23.42 [0.922]	3.12 [0.123]	20.62 [0.812]
15	26.97 [0.969]	26.59 [1.047]	3.12 [0.123]	23.01 [0.906]
17	24.61 [0.062]	30.96 [1.219]	3.12 [0.123]	24.61 [0.969]
19	29.36 [1.156]	32.94 [1.297]	3.12 [0.123]	26.97 [1.062]
21	31.75 [1.250]	36.12 [1.422]	3.12 [0.123]	29.36 [1.156]
23	34.93 [1.375]	39.29 [1.547]	3.78 [0.149]	31.75 [1.250]
25	38.10 [1.500]	42.47 [1.672]	3.78 [0.149]	34.93 [1.375]

Jam Nut Receptacle

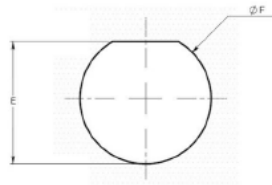
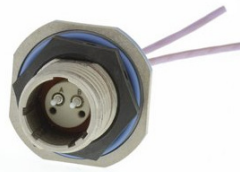

Shell Size	Dia. E max. mm (inch)	Dia. F max. mm (inch)
11	19.28 [0.729]	20.88 [0.822]
13	24.01 [0.945]	25.58 [1.007]
15	27.28 [1.074]	28.80 [1.134]
17	30.43 [1.198]	31.98 [1.259]
19	33.61 [1.323]	35.15 [1.384]
21	36.81 [1.449]	38.28 [1.507]
23	39.99 [1.574]	41.50 [1.634]
25	43.16 [1.699]	44.68 [1.759]

Plug Dimensions

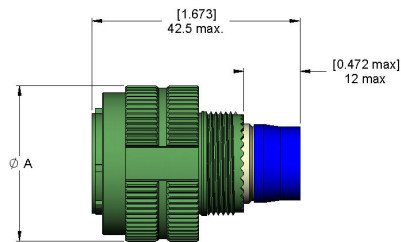

Shell Size	Dia. A max. mm (inch)
11	25.00 [0.984]
13	29.40 [1.157]
15	32.50 [1.280]
17	35.70 [1.405]
19	38.50 [1.516]
21	41.70 [1.642]
23	44.90 [1.768]
25	48.00 [1.890]

R8 Series: MIL-DTL-38999 Type

INSERT ARRANGEMENTS

Optical Insert Arrangements

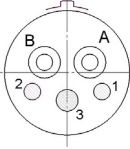
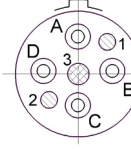
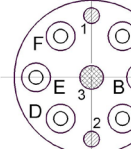
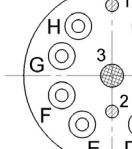
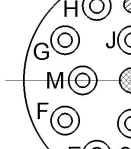
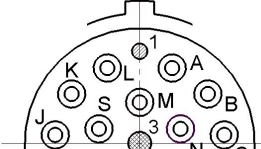
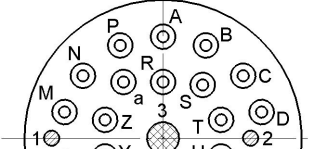
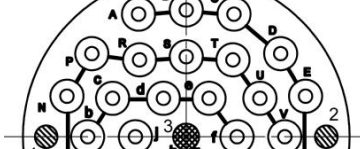
				
Size 11 for 2 LuxCis® contacts	Size 13 for 4 LuxCis® contacts	Size 15 for 6 LuxCis® contacts	Size 17 for 8 LuxCis® contacts	Size 19 for 12 LuxCis® contacts
				
Size 21 for 16 LuxCis® contacts	Size 23 for 24 LuxCis® contacts	Size 25 for 32 LuxCis® contacts		

All views show the front face of a plug.

Hybrid Insert Arrangements

The LuxCis® ARINC 801 product range also includes hybrid connectors, mixing electrical and optical contacts. Hybrid connectors are available in various sizes. For any additional information, please contact your local Radiall representative.

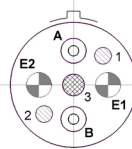
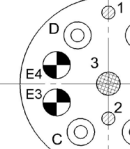
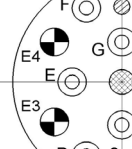
		
Size 13 for 2 electrical contacts and 2 LuxCis® contacts	Size 17 for 4 electrical contacts and 4 LuxCis® contacts	Size 19 for 4 electrical contacts and 8 LuxCis® contacts

Legend:

1 & 2: Alignment pins
3: Sleeve-holder screw
A & B: Optical cavities

E1 & E2: Electrical cavities (Refer to Technical Data Sheet to see the exact marking on the connector)

R8 Series: MIL-DTL-38999 Type

HOW TO ORDER R8 CONNECTORS

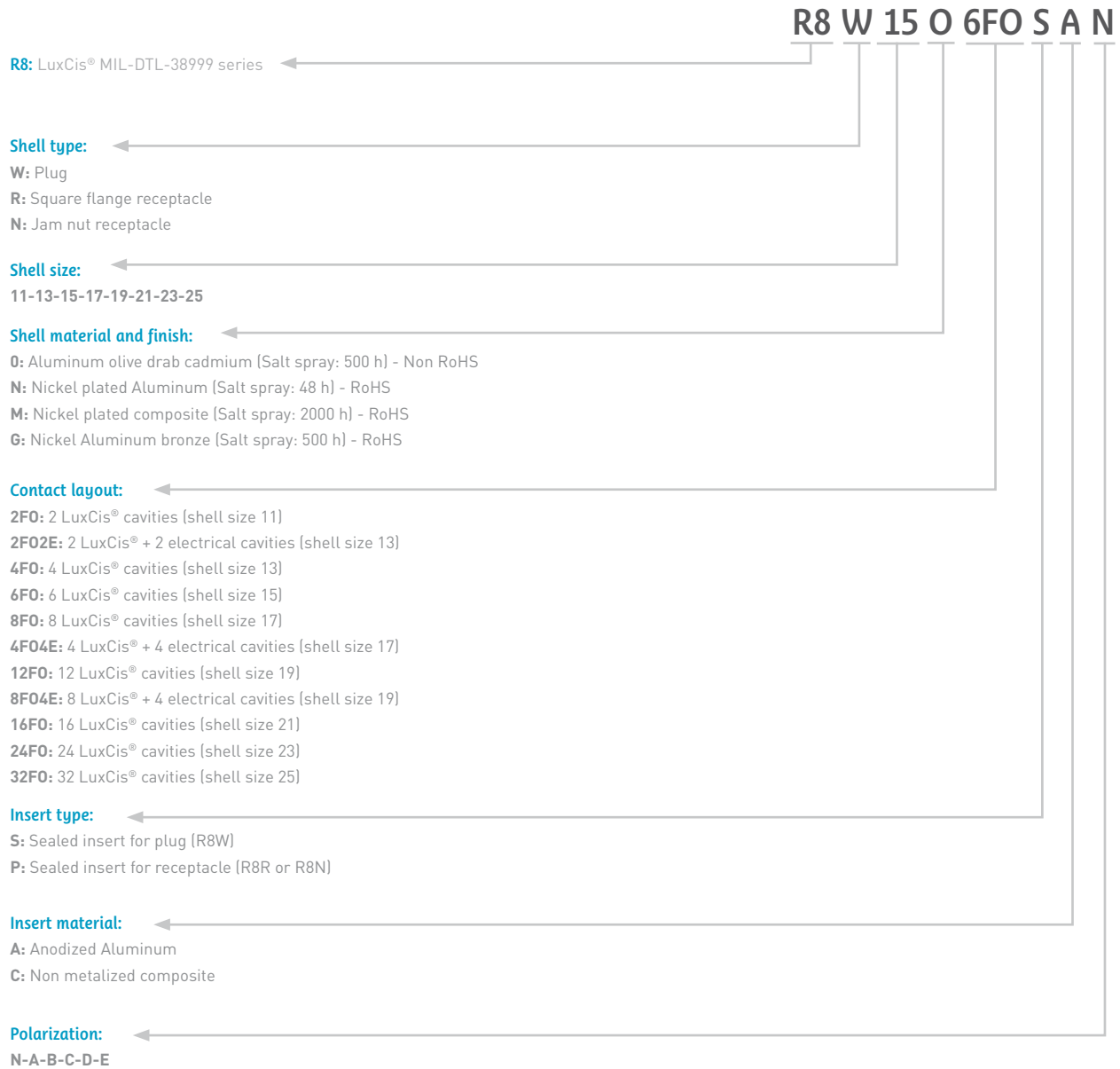

All connectors are supplied with a plastic cap. All connectors are delivered without contacts.

Plugs are delivered with sleeve holders.

Accessories such as backshells or metalized caps must be ordered separately.

Material and weight information are available upon request.

Don't hesitate to contact us for specific requirements such as custom configurations.

Radiall can support your cable assembly needs. Refer to Section 9 for our cable and harness assemblies.

R9 Series: Hermetic MIL-DTL-38999 Type



HERMETIC MIL-DTL-38999 TYPE CONNECTORS FOR LUXCIS® ARINC 801 CONTACTS

The LuxCis® ARINC 801 product range also includes an hermetic version of the proven 38999 multi-channel connector. Radiall's R9 series provides high level of hermeticity and complies with ARINC specifications and 38999 series III dimensions.

APPLICATIONS

For harsh environment applications, the LuxCis® hermetic MIL-DTL-38999 type connectors are an optimal solution when secure and hermetic connection is required:

- Pressurized/unpressurized transitions
- Sensors in specific gas environments
- Pressurized box

STANDARDS

- Compliant with ARINC 801 specifications
- RoHS compliant



FEATURES AND BENEFITS

HERMETICITY: 10⁻⁷ bar.cm³/s

- Designed on MIL-DTL 38999 type connector parameters
- Sealed and robust connection
- Optimized alignment of fiber optic contacts
- Designed and qualified for PC, UPC and APC terminations
- Material: Nickel Plated Aluminum
- Resists to moisture ingress and operates at high altitudes, under extreme atmospheric pressure and in fast changing temperature conditions

PRODUCT RANGE

- Available in pigtail solution to mate with all MIL-DTL-38999 type connector sizes 11, 13, 15 and 21
- Various pigtail lengths available
- A bulkhead feed through adapter solution is also available

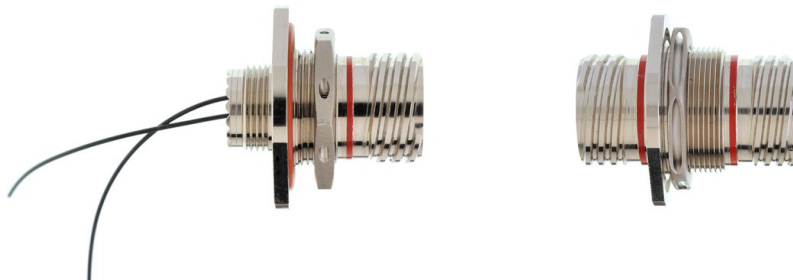

R9 Series: Hermetic MIL-DTL-38999 Type

MECHANICAL AND ENVIRONMENTAL CHARACTERISTICS

Test	Standard	LuxCis® in R9 Hermetic pigtailed MIL-DTL-38999 Connector
Thermal cycling	EIA-364-32C test condition 1	-55°C/+100°C
Salt spray	EIA-364-26B test condition A	96 hours
Temperature life	TIA/EIA-455-4C, code 3, condition D	1000 h at 85°C
Connector durability	EIA-364-09C, 100 cycles	100 mating cycles
Random vibration	TIA/EIA-455-11, condition C	23.1 Grms
Shocks	TIA/EIA-455-14, condition A	300 G, 3 ms
Humidity	TIA/EIA-455-5C	96 h, +40°C, relative humidity 95%
Air leakage	TIA/EIA-464-12-15A	He 10-7 bar.cm3/s

SHELL DIMENSIONS

R9 jam nut hermetic pigtailed receptacle

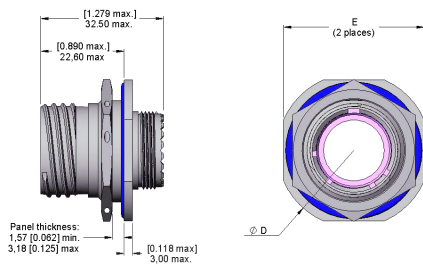

Shell Size	E max. mm (inch)	Dia. D max. mm (inch)
11	32.20 (1.268)	35.20 (1.386)
13	35.30 (1.390)	38.40 (1.512)
15	38.50 (1.516)	41.60 (1.638)
21	49.60 (1.953)	52.70 (2.075)

Panel cut out

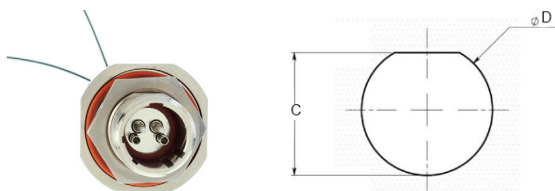

Shell Size	C max. mm (inch)	Dia. D max. mm (inch)
11	19.28 (0.729)	20.88 (0.822)
13	24.01 (0.945)	25.58 (1.007)
15	27.28 (1.074)	28.80 (1.134)
21	36.81 (1.449)	38.28 (1.507)

For any additional information, please contact your local Radiall representative.

LxC-R® Series: Single Channel

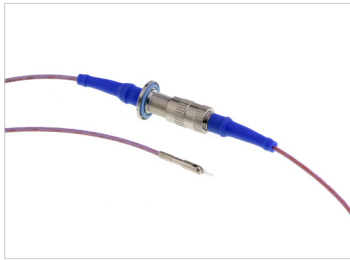

Miniature and robust, this unique single channel connector is ideally suited for applications requiring a single high-performance transmission in extreme environments such as in aerospace and military equipment. Specifically designed to be compatible with the industry standard LuxCis® ARINC 801 fiber optic contact, the LxC-R® is qualified to withstand high levels of vibrations and shocks.

The flexibility of the LuxCis® ARINC 801 contact allows the use of either MultiMode or SingleMode fibers for both PC and APC terminations. The LxC-R® product range includes plugs, square flange and jam nut receptacles, as well as hermetic configurations.

STANDARDS

- RoHS compliant



FEATURES AND BENEFITS

High Performance

- Optimized alignment of LuxCis® ARINC 801 fiber optic contacts
- Designed and qualified for PC, UPC and APC terminations
- Hermetic version available

Direct Sealed Connection: IP67 Level

- Interfacial gasket: shell to shell sealing
- Jam nut receptacle with O-ring for panel sealing
- Sealing boot: environmental grommet also guiding the fiber at the rear of the connector

Easy to Install

- Screwing locking mechanism
- Easy insertion/extraction of the LuxCis® ARINC 801 contact using M81969/14-03 standardized tool (Radiall PN 282 515)

Robust Single Connection

- Full pull-proof design with loose structure cable
- Anti-vibration coupling mechanism
- Two polarization keys available: 90° or 120°
- Small form factor

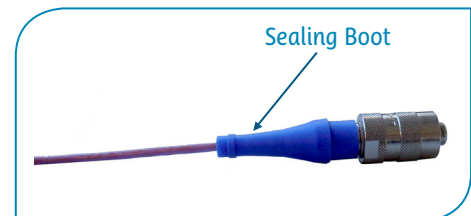
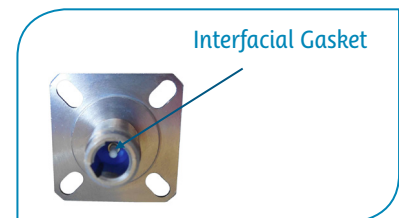

LxC-R® AND SIZE 9 MIL-DTL-38999 CONNECTOR COMPARISON:

Connector's front view

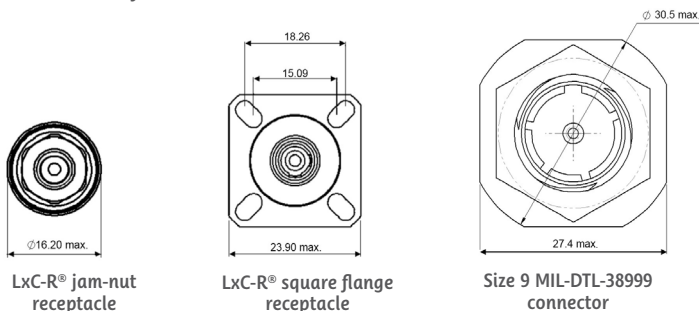

LxC-R® Series: Single Channel

MECHANICAL AND ENVIRONMENTAL CHARACTERISTICS

Test	Standard	LuxCis® in LxC-R® Connectors
Thermal cycling	SAE AS 13441 method 1003.1	-65°C/+155°C (cable dependent)
Temperature endurance	TIA/EIA 455-4	1000 h @ 125°C (cable dependent)
Vibration	TIA/EIA 455-11	50 Grms
Shocks	TIA/EIA 455-14	300G, 3 ms
Durability	TIA/EIA 364-09	500 cycles
Maintenance aging	SAE AS 13441 method 2002.1	10 cycles
Cable retention 1.8 mm diameter 900 µm diameter	SAE AS 13441 method 2009.1	68 N 7 N
Humidity	TIA/EIA 455-5	10 cycles/24 h; 90% RH; -25°C/+65°C
Salt spray	SAE AS 13441 method 1001.1	96h for LXCRxxxxxAxx 500h for LXCRxxxxxLxx

SHELL DIMENSIONS

Plug Dimensions

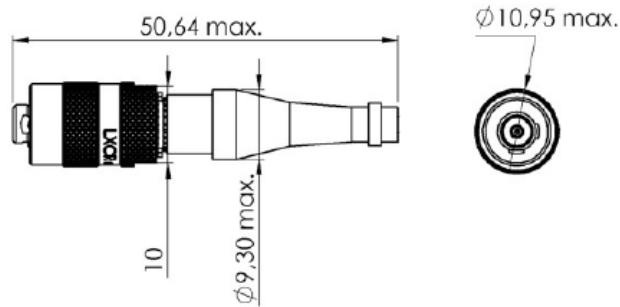

Square Flange Receptacle Dimensions

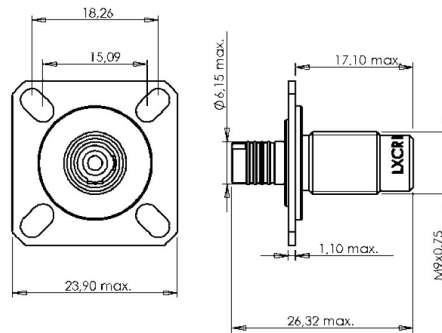
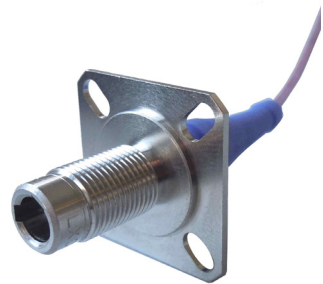

Mounting Dimensions

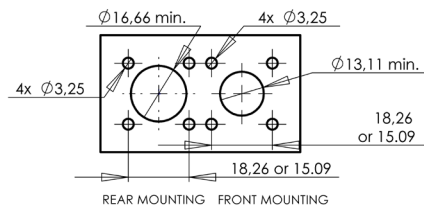

LxC-R® Series: Single Channel

Jam Nut Receptacle Dimensions

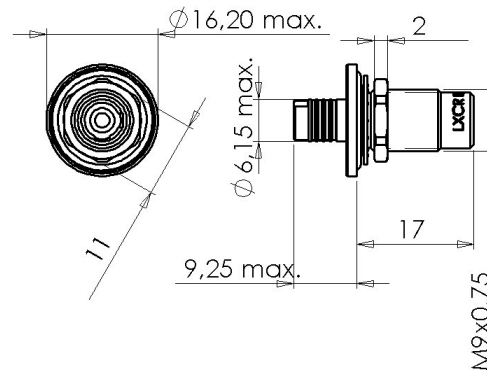

Mounting Dimensions

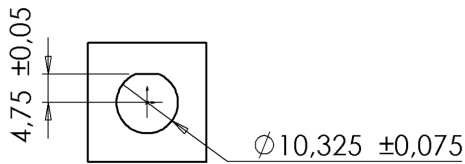

HOW TO ORDER LxC-R® CONNECTORS

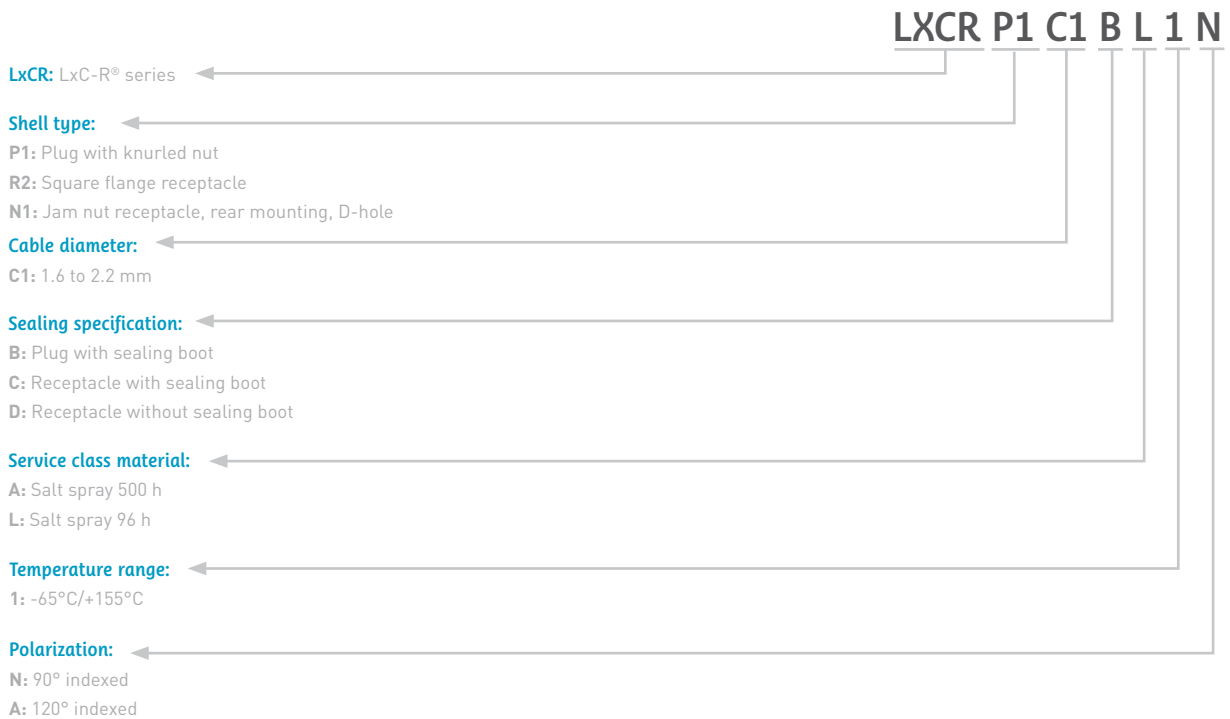

Notes: Plugs and receptacles are delivered with plastic caps. Metallic caps and other accessories are available on upon request

Custom Design Connectors

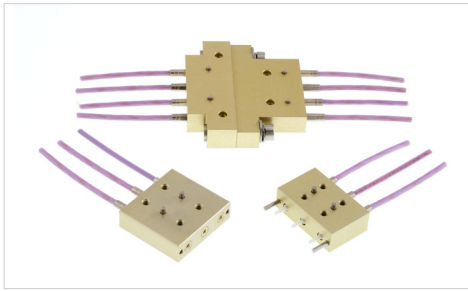

Radiall also designs LuxCis® ARINC 801 connectors to meet customers' footprints and space on the board, in the box or at the box interface.

Each connector integrates a number of LuxCis® ARINC 801 cavities and the locking mechanism depends on the application and the environment required by the customer.

Please contact your sales representative for a custom LuxCis® ARINC 801 connector.

Harnesses and Optical System Capability

OPTICAL SYSTEM CAPABILITY

Radiall's design and manufacturing expertise, together with its wide interconnect product offerings, enable Radiall to meet customers' needs for custom harness solutions. We can provide support for optical links requiring excellent performance and ease of installation, as well as develop application specific accessories or interconnect solutions when required.

Radiall is able to support a wide range of requirements, from simple contact and connector solutions to the most complex fiber optic based harnesses or sub systems for harsh environments.



Refer to Section 9 for more information on Radiall's optical systems, harnesses and cable assembly capabilities. For any additional information, please contact your local Radiall representative

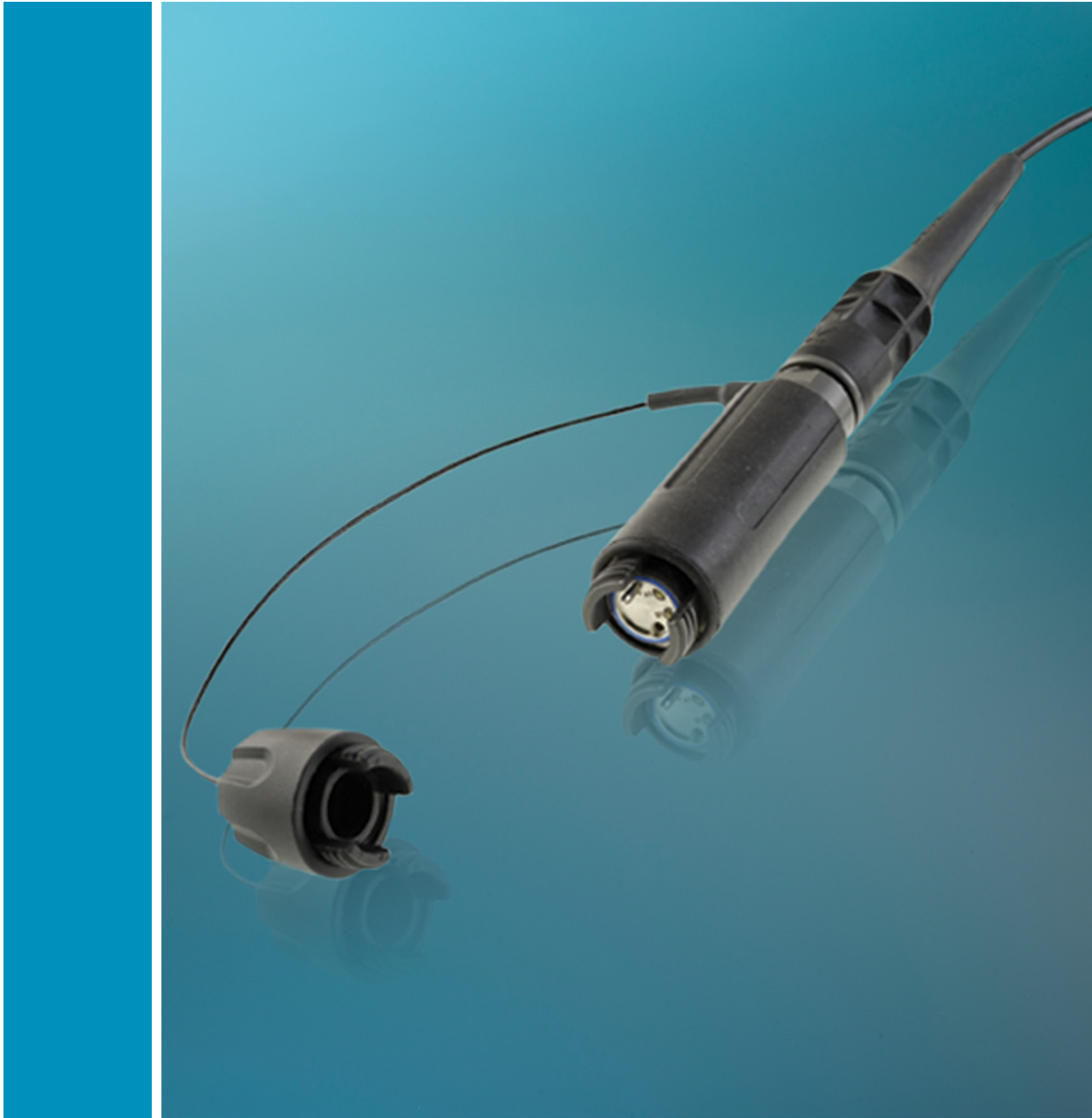

Expanded Beam Solutions

F739, F746, F730



Contents

Introduction	
Expanded Beam Solutions	3-2
Markets and Applications	3-2
International Standard Documents Compliance	3-2
Expanded Beam Technology	3-3
Features and Benefits	3-3
Product Range Overview	3-4
EB Tactical Cable Assemblies - F739 Series	
Features and Benefits	3-5
Characteristics and Performance	3-6
Connector Dimensions	3-7
How to Order	3-8
Reels Range	3-9
Range Extension	3-9
EB-LuxCis® Product Range - F746 Series	
Features and Benefits	3-10
Characteristics and Performance	3-10
Product Range	3-11
Range Extension	3-12
EB Contact in Multipin Connectors - F730 Series	3-13
Features and Benefits	3-13
Characteristics and Performance	3-14
Dimensions	3-14
Product Range	3-15
Range Extension	3-15

Introduction

EXPANDED BEAM SOLUTIONS

Radiall offers a wide range of interconnect solutions based on Expanded Beam (EB) technology. Experience and expertise allow Radiall to provide high quality products in support of demanding applications. Expanded beam is a flexible solution that brings reliable optical performance in harsh environments, especially when ease of cleaning, maintenance or a high number of matings is required.

MARKETS AND APPLICATIONS

Aerospace Defense Industrial



Aerospace

Avionics, data link high speed digital transmissions

Military

Field deployable communication, mobile shelters, marine and battlefield environments

Geophysical

Oil and gas, mining, seismic exploration systems

Other Applications

Broadcast, robotics, transportation, sensors



- MIL-DTL-83526/20 and MIL-DTL-83526/21
- RoHS compliant
- AS 6250



Introduction

EXPANDED BEAM TECHNOLOGY

Expanded Beam technology uses a precision lens on one mating end (connector A) to collimate and expand the emerging light beam, before a matching lens on the other mating end (connector B) refocuses the light back into the fiber core.

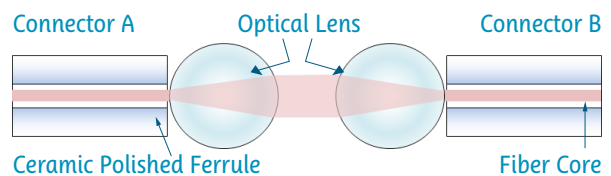

EB technology offers a contactless connection which increases the number of mating cycles compared to connectors based on Physical Contact technology. Due to the signal being expanded, the connection is also less sensitive to particular contamination and supports an easier cleaning process. This makes it the ideal choice for demanding applications requiring ease of maintenance in highly contaminated environments.

The diagram compares a Standard Beam (small circle) and an Expanded Beam (large circle). A dust particle is shown near the Standard Beam, and a larger misalignment is shown between the two beams. The Expanded Beam is shown to be less affected by these issues.

- Lateral misalignment has less effect on transmission loss when the light beam is expanded.
- Particulate contamination has less effect on transmission loss when the light beam is expanded.

Reliable Connection

- Contactless connection increasing operational longevity and reliability
- Less sensitivity to lateral misalignment and particulate contamination

Field Optimized Technology

- Easy cleaning
- Resistance to mechanical shock and vibration

Versatile Solution

- Compatible with MultiMode and SingleMode fibers
- Adapted to various cable configurations
- Wide range of Expanded Beam interconnect solutions

Introduction

PRODUCT RANGE OVERVIEW

Radiall offers a variety of custom cable assemblies featuring Expanded Beam technology, in 3 series:

EB Tactical Cable Assemblies - F739 Series:

Ruggedized and easy to deploy and maintain in the field, cable assemblies equipped with Expanded Beam Tactical connectors are well adapted to outdoor and demanding applications in the field.



EB-LuxCis® Product Range - F746 Series:

EB-LuxCis® product range combines the benefits of the LuxCis® ARINC 801 fiber optic contact and Expanded Beam technology where multipin connectors are widely used.



EB Contact in Multipin Connectors - F730 Series:

The EB contact provides benefits similar to individual termini with all the advantages of the Expanded Beam technology: easy insertion/extraction manipulation, easy part replacement and use of standard cavities.



EB Tactical Cable Assemblies - F739 Series



Radiall designs, manufactures and supplies cable assemblies equipped with EB Tactical connectors to withstand the most demanding environments. These rugged cable assemblies feature high robustness with ease of deployment and low maintenance in the field.

EXPANDED BEAM TECHNOLOGY - KEY BENEFITS:

Reliable Connection

- Contactless connection increasing operational longevity and reliability
- Less sensitivity to lateral misalignment and particulate contamination

Field Optimized Technology

- Easy cleaning
- Resistance to mechanical shock and vibration

Versatile Solution

- Compatible with MultiMode and SingleMode fibers
- Adapted to various cable configurations
- Wide range of Expanded Beam interconnect solutions

EB TACTICAL CABLE ASSEMBLIES - KEY BENEFITS:

Field Optimized

- Hermaphroditic (genderless) design for fast and easy connection, enabling mistake-proof tactical field deployment and daisy chaining (concatenation) configurations to address longer links in the field.

Flexible Configuration

- Different operating wavelengths available (850 nm/1300 nm dual wavelengths, 1310 nm or 1550 nm wavelengths)
- Expanded Beam receptacles available in square flange and jam nut (D-hole)
- EB Tactical connectors are available with up to 4 channels

Ruggedized Solution

- Robust construction with very high mating cycle capability: up to 3000 cycles

EB Tactical Cable Assemblies - F739 Series

The EB Tactical connectors are designed to MIL-DTL-83526/20 & /21 mechanical interface standards.

OPTICAL CHARACTERISTICS

	MultiMode PC 1300 nm	SingleMode PC 1310 nm
Insertion Loss* (Typical)	0.7 dB	0.7 dB
Insertion Loss (Maximum)	1.5 dB	2 dB
Return Loss**		>34 dB

*When tested with reference quality launch/receive cable assemblies

**RL tested unmated

MECHANICAL CHARACTERISTICS

Vibration, sinusoidal	10–500 Hz, 3 directions, 0.75 mm amplitude, 10 G acceleration
Bumps	4000 bumps, 3 directions, 40 G acceleration
Free fall on concrete, severity 1.2 m	500 falls
Mating endurance	Up to 3000 mating cycles

Operating temperature range	-40°C/+85°C
Storage temperature	-55°C/+85°C
Humidity (damp heat)	95% RH
Water immersion	15 m depth

MATERIALS

Shell	Aluminum
Plating	Clear hard anodized
Plug Boot	EPDM rubber (high resistance to tearing and damage, ideal for outdoor exposure)

Expanded Beam connectors are optimized for the following operating wavelengths:

- MM 850 nm
- MM 1300 nm
- SM 1310 nm
- SM 1550 nm

Other wavelengths can be used as well (for WDM applications for example).

For other wavelengths or materials such as Nickel Aluminum Bronze connectors for naval applications, please contact your local Radiall representative.

EB Tactical Cable Assemblies - F739 Series

CONNECTOR DIMENSIONS

Expanded Beam Tactical Plug

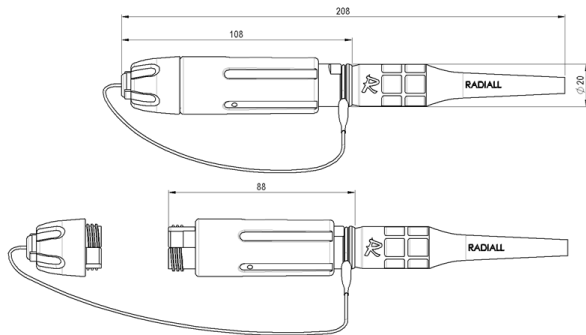

Expanded Beam Tactical Square Flange Bulkhead

For Multi-fiber cable

Low profile, to be assembled with up to 4 individual cables, max diameter 1.6 mm

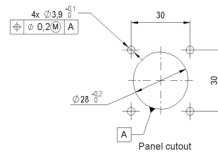
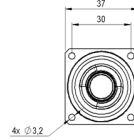
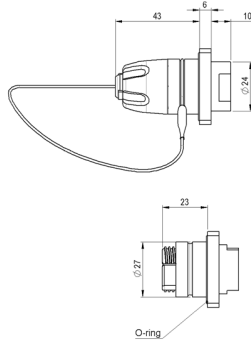
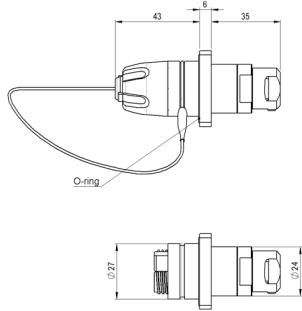

Expanded Beam Tactical Jam Nut (D-Hole) Bulkhead Receptacle

For Multi-fiber cable

Low profile, to be assembled with up to 4 individual cables, max diameter 1.6 mm

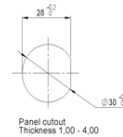
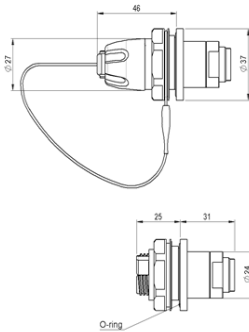
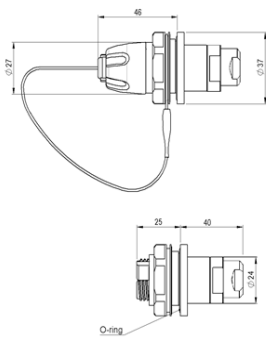

Dimensions in mm

EB Tactical Cable Assemblies - F739 Series

Use this configurator to define a part number for standard tactical cable assemblies using Expanded Beam Junior size tactical connectors. EB Junior size tactical connectors are designed to MIL-DTL-83526/20 & /21 mechanical interfaces standards.

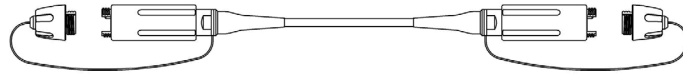

F739 0 0 4 2 1 1 M 100

F739 Series: EB tactical cable assembly

End 1: Junior size EB tactical connector

- 0: Plug
- 2: D-hole receptacle low profile, fan-out type for 1.6 to 1.8 mm simplex cable
- 3: D-hole receptacle, for 5 to 6 mm tactical cable
- 5: Square flange receptacle low profile, fan-out type for 1.6 to 1.8 mm simplex cable
- 6: Square flange receptacle, for 5 to 6 mm tactical cable

End 2:

- 0: Junior size EB plug
- 2: Free end
- 3: LC PC connector
- 4: LC APC connector
- 5: ST PC connector
- 6: SC PC connector
- 7: LuxCis® ARINC 801 APC contact
- 8: FC PC connector
- 9: LuxCis® ARINC 801 PC contact

Number of channels: 2 or 4

Optimal wavelength:

- 2: SingleMode 1310 nm
- 3: SingleMode 1550 nm
- 4: MultiMode 850 nm & 1300 nm with 50/125 µm OM3 fiber
- 5: MultiMode 850 nm & 1300 nm with 50/125 µm fiber
- 6: MultiMode 850 nm & 1300 nm with 62.5/125 µm fiber

Cable type:

- 1: Multi-fiber cable, diameter 5 to 6 mm, for plug and standard receptacle
- 4: Multi-fiber cable, diameter 5 to 6 mm, anti-rodent with bittering agent, for plug and standard receptacle
- 5: Simplex fiber, diameter 1.6 to 1.8 mm for fan-out receptacle (low-profile) only
- 6: Multi-fiber armored cable, for plug and standard receptacle

Reel:

- 0: No cable reel (applicable for cable up to 20 m length)
- 1: Field deployable reel
- 5: Reel for backpack (applicable for cable up to 900 m cable length)
- 6: Disposable reel

Length unit:

- C: Centimeter
- M: Meter

Length of the cable (3 digits)

Each cable assembly is labeled with a heat shrink sleeve with Radiall PN and date code.

For any other cable assembly configuration or specific requirements (additional testing, specific labeling, additional protection or different type of cable), please contact your local Radiall representative and we will provide a technical datasheet for validation.

EB Tactical Cable Assemblies - F739 Series

REELS RANGE

Radiall provides cable assemblies with various field orientated accessories such as reels and backpack reels.

Standard cable drums are available in 2 sizes:

Gantry Reel – size A

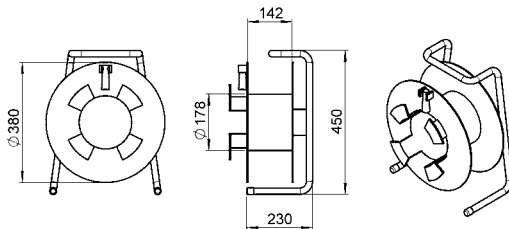

Gantry Reel – size B

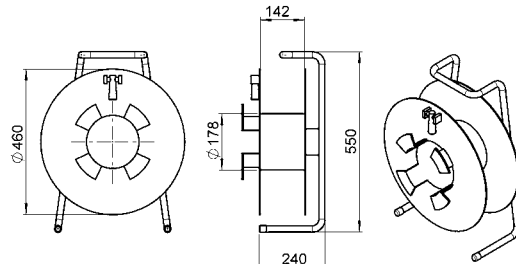

Gantry drum, with braking device and handle crank

	Size A	Size B
Color	Black	
Weight	5.90 kg	8.20 kg
Cable assembly max. length	Up to 280 m (with a 6 mm cable)	Up to 450 m (with a 6 mm cable)



RANGE EXTENSION

Not all accessories are displayed in this catalog.

Radiall is also designing other Expanded Beam solutions that provide:

- Smaller size with the mini insert (shrunk version of the Junior insert)
- More channels
- Hybrid configurations
- Environment specific designs

For any additional information, please contact your local Radiall representative.

EB-LuxCis® Product Range - F746 Series



Radiall's product line also features the EB-LuxCis® product range, bringing the benefits of the LuxCis® ARINC 801 fiber optic contact and Expanded Beam technology where multipin connectors are widely used.

The EB-LuxCis® product range combines the widely used LuxCis® ARINC 801 fiber optic contact inserted in a 2 or 4 channel (MM or SM) Expanded Beam insert, which can be used in various circular or rectangular connectors.

It is the ideal solution for demanding applications requiring ease of maintenance in highly contaminated environments.



FEATURES AND BENEFITS

EXPANDED BEAM TECHNOLOGY - KEY BENEFITS:

Reliable Connection

- Contactless connection increasing operational longevity and reliability
- Less sensitivity to lateral misalignment and particulate contamination

Field Optimized Technology

- Easy cleaning
- Resistance to mechanical shock and vibration

Versatile Solution

- Compatible with MultiMode and SingleMode fibers
- Adapted to various cable configurations
- Wide range of Expanded Beam interconnect solutions

EB-LUXCIS® - KEY BENEFITS:

Improved Field Maintenance

- Combined with standard LuxCis® ARINC 801 contacts, a standardized interface
- Easy insertion and extraction of the contacts using standard tools

Flexible Configuration

- Non-hermaphroditic and hermaphroditic inserts available
- Wide product range available: MIL-DTL-38999, EPX®, NSX ARINC 600, EN 4165

Ruggedized Solution

- Robust construction based on widely used multipin connectors in harsh environments
- Scoop proof inserts available
- Interfacial seal and O-ring system to ensure a good sealing level

EB-LuxCis® Product Range - F746 Series

CHARACTERISTICS AND PERFORMANCE

OPTICAL CHARACTERISTICS

Test	Standard	EB-LuxCis® EN4165 Rack & Panel or D38999 Connector	
		SingleMode PC 1310-1550 nm	MultiMode PC 850 nm
Insertion Loss (maximum)	EN2591-601	2 dB	2 dB
Return Loss	EN2591-605	>30 dB	>20 dB

MECHANICAL CHARACTERISTICS

Test	Standard	EB-LuxCis® EN4165 Rack & Panel or D38999 Connector
Vibration	EN2591-6403 Method B	up to 16 Grms
Shocks	EN2591-6402 Method A 3 directions	100 G
Durability (mating/unmating)	EN2591-6406	500 cycles
Cable retention 1.8 mm diameter		68 N

ENVIRONMENTAL CHARACTERISTICS

Test	Standard	EB-LuxCis® EN4165 Rack & Panel or D38999 Connector
Operating temperature	EN2591-6305	-55°C/+125°C (cable dependent)
Temperature endurance	EN2591-6301 Method B	1000 h at 125°C (cable dependent)
Altitude immersion at low pressure	EN2591-6314	65,000 feet

Note: The EB-LuxCis® has passed a full qualification. Not all the tests performed are described in the tables above. Request for information on a test not mentioned in the table or harsher conditions shall be addressed to your local Radiall representative.

EXPANDED BEAM

EB-LuxCis® Product Range - F746 Series

PRODUCT RANGE

Radiall designs, manufactures and delivers harnesses equipped with EB-LuxCis® interconnect solutions for demanding applications requiring ease of maintenance in highly contaminated environments.

The EB-LuxCis® can accommodate either MultiMode or SingleMode fibers and up to 4 cable assemblies equipped with LuxCis® ARINC 801 contacts. It is available in hermaphroditic (for easier mating possibility) and non-hermaphroditic versions (male/female to avoid channels inversion).

MIL-DTL-38999 size 11 connector

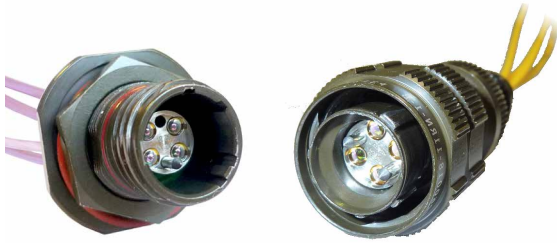

EN4165 module



RANGE EXTENSION

EPX® connector



The EB-LuxCis® is also available for other tactical and multipin connectors, such as NSX ARINC 600 connectors. For any additional information, please contact your local Radiall representative.

EB Contact in Multipin Connectors - F730 Series



Radiall provides and assembles EB contacts within multipin connectors. The EB contact is available in male and female configurations, fitting into standard size 16 cavities. Maintaining the same form factor as the MIL-PRF-29504/4 & /5 envelope, the EB contact upgrades the MIL-DTL-38999 with Expanded Beam technology. Using the proven alignment technique with a ceramic ferrule, this EB contact solution withstands the most extreme environmental conditions and provides reduced sensitivity to contamination, vibration and temperature changes.

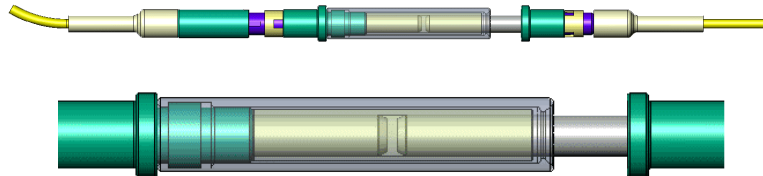

FEATURES AND BENEFITS

EXPANDED BEAM TECHNOLOGY - KEY BENEFITS:

Reliable Connection

- Contactless connection increasing operational longevity and reliability
- Less sensitivity to lateral misalignment and particulate contamination

Field Optimized Technology

- Easy cleaning
- Resistance to mechanical shock and vibration

Versatile Solution

- Compatible with MultiMode and SingleMode fibers
- Adapted to various cable configurations
- Wide range of Expanded Beam interconnect solutions

EB CONTACT - KEY BENEFITS:

Highest Density EB Solution

- Small form factor for high density connections and effortless manipulation

Flexible Solution

- Interchangeable with electrical contacts
- Designed to fit into standard size 16 cavities of MIL-DTL-38999 connectors
- Available in pin and socket for SingleMode and MultiMode fibers (62.5/125 μm and 50/125 μm)

Reduced Maintenance

- Easy part replacement: rear release and rear removable with standard insertion/extraction tools

EB Contact in Multipin Connectors - F730 Series

CHARACTERISTICS AND PERFORMANCE

OPTICAL CHARACTERISTICS

	MultiMode PC	SingleMode PC
Insertion loss, typical	0.4 dB	0.8 dB
Insertion loss, maximum (against reference patchcord)	1.0 dB	1.5 dB
Return loss	>20 dB	

MECHANICAL CHARACTERISTICS

Vibrations	28 G
Mating endurance	500 matings (connector dependent)

ENVIRONMENTAL CHARACTERISTICS

Operating temperature range	-40° C/+125° C (cable dependent)
Temperature shock (TIA-455-71)	-55° C/+165° C (cable dependent)
Temperature life 1000 h (TIA-455-4)	+165° C (cable dependent)
Storage temperature	-55° C/+85° C

MATERIALS

The EB contact is RoHS compliant



Body	Metal
Sleeve	Ceramic (Zirconia)

DIMENSIONS

Female EB contact 29504/5 size 16

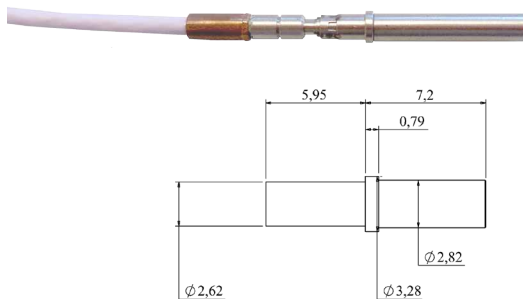

Male EB contact 29504/4 size 16

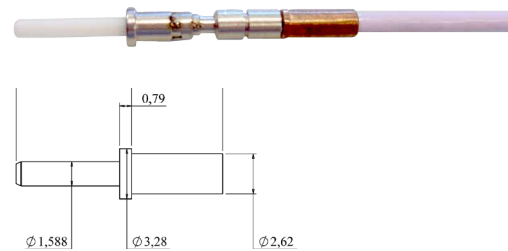

Mated EB contacts

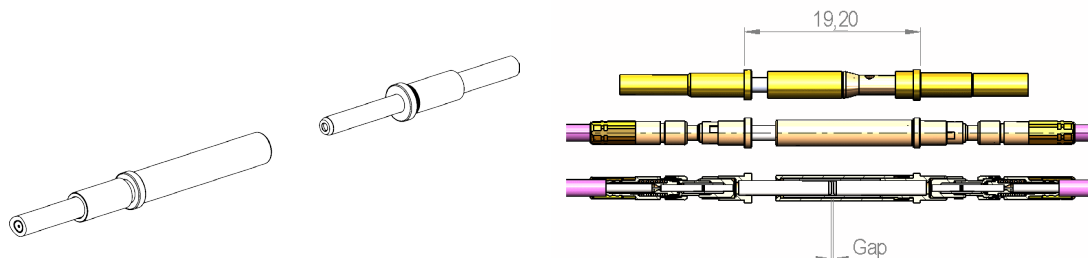

EB Contact in Multipin Connectors - F730 Series

PRODUCT RANGE

F730 product range includes EB contacts for the following configurations:

- For MIL-DTL-38999 connectors
- Male contact MIL-PRF-29504/4 size 16 and female contact MIL-PRF-29504/5 size 16
- MultiMode or SingleMode fiber



RANGE EXTENSION



EB contacts are also available for other multipin connectors. For any additional information, please contact your local Radiall representative.

Notes



LC, SC and ST Series

F727, F728 and F709



Contents

Introduction	
LC, SC and ST Series	4-2
Markets and Applications	4-2
International Standard Documents Compliance	4-2
LC Series	
Features and Benefits	4-3
LC Standard	4-4 to 4-5
LC for Harsh Environments	4-6
LC Adapters	4-7
SC Series	
Features and Benefits	4-8
SC Standard	4-9 to 4-10
SC for Harsh Environments	4-11
SC Adapters	4-12
ST Series	
Features and Benefits	4-13
ST Standard.....	4-14
ST Sealed Connection	4-15
ST for Harsh Environments	4-16
ST Receptacles	4-17
ST Adapters	4-17
Accessories for LC, SC and ST Series	
Duplex Removable Clips	4-18
Inner Sleeves	4-18
Crimping Rings	4-19
Connector Caps	4-19
Boots	4-20 to 4-21
Connector Kit Configurators	
LC Kit Configurator	4-22
SC Kit Configurator	4-23
ST Kit Configurator	4-23

Introduction

LC, SC AND ST SERIES

Radiall manufactures and offers a full range of LC, SC and ST connectors, adapters and accessories.

Each series is available in 2 versions to withstand the required environmental conditions:

- A standard range for indoor applications
- An ruggedized range specifically designed to perform with aerospace cables in harsh environmental conditions

MARKETS AND APPLICATIONS

Telecommunication

- Telecommunication networks, Fiber Channel for Storage Area Network (SAN), Local Area Networks (LAN), FTTH

Datacom

- Data converter, junction boxes, termination box, optical distribution frame

Broadcast

- Broadcast TV program, transport high speed data flow by computer through CATV

Medical

- Imaging devices, surgical instruments, sensors and equipment interconnects

Instrumentation

- Input/output of measurement boxes, optical sensors

Industrial

- Video surveillance, fiber optic sensor for industrial processes (measuring and control)

Military, Aerospace and Navy

- Environmental and structural sensors, data transmissions



Aerospace



Defense



Industrial



Telecom



Instrumentation



Medical



INTERNATIONAL STANDARD DOCUMENTS COMPLIANCE

- GR-326-CORE Telcordia specification
- IEC 61300 Fiber optic interconnecting devices and passive components
- RoHS compliant

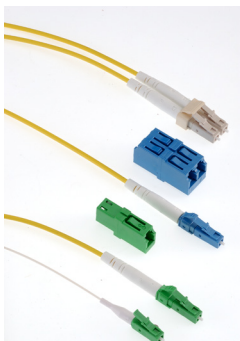

LC: IEC 61754-20

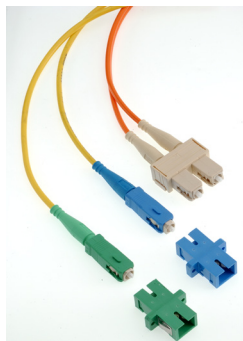

SC: IEC 61754-4



ST: IEC 61754-2

LC Series

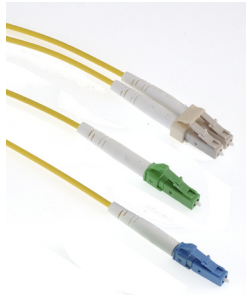

FEATURES AND BENEFITS

Easy Mounting and Installation

- Small Form Factor for high density applications (LC connector is half of the size of SC connector)
- Push-pull self latching system for quick insertion and extraction even on very dense circuitry
- Color coding for easy identification
- Proprietary secure bonding to protect the floating mechanism during the resin injection process.
- 8° pre-angled APC version is available to ease and speed up the installation in the field

High Performance

- High precision alignment with proven 1.25 mm zirconia ferrule
- APC polishing available (RL>65dB)
- Facilitates high speed applications with lower power requirements due to low Insertion loss (0.1 dB typical)

Secure Connection

- Spring loaded mechanism
- Pull-proof design with loose structure configuration to guarantee no optical disconnection when pulling on the cable.
- Radiall has improved the crimping reliability by using a small metallic tube to protect the fiber while reducing stress and ensuring excellent cable retention.

Versatile

- Adapted to MultiMode, SingleMode, PC, UPC and APC polishing
- Can be assembled in duplex configuration with a removable clip
- Two types available: standard and aerospace grade
- Various protection boots are available with exclusive shapes to tighten the cable and maintain high optical performance even when the cable is bent or pulled
- Connectors and adapters are manufactured under a worldwide license from OFS, formerly known as Lucent Technologies.

LC STANDARD CHARACTERISTICS AND PERFORMANCE
OPTICAL CHARACTERISTICS

	SingleMode UPC	SingleMode APC	MultiMode PC
Wavelength	1310 - 1550 nm		850 - 1300 nm
Insertion loss			
Mean	0.10 dB	0.15 dB	0.10 dB
Standard deviation	0.05 dB	0.10 dB	0.05 dB
Return loss	> 50 dB	> 65 dB	> 20 dB

Insertion Loss against a reference patchcord: IEC 61300-3-4 Method B

Return Loss: IEC 61300-3-6

MECHANICAL CHARACTERISTICS

	Cable Diameter 2 & 3 mm
Cable retention	68 N
Mechanical endurance	200 matings

ENVIRONMENTAL CHARACTERISTICS

Operating temperature	-40°C / +85°C
Storage temperature	-40°C / +85°C

MATERIALS

Molded plastic parts	V0 (UL 94)
Optical ferrule (connector)	Zirconia
Alignment sleeve (adapter)	Zirconia

LC Series



SIMPLEX LC CONNECTORS

The simplex connectors are supplied with straight boots, dust caps and crimping accessories, except for the “level 0” categories which enable users to configure their connectors according to their requirements.

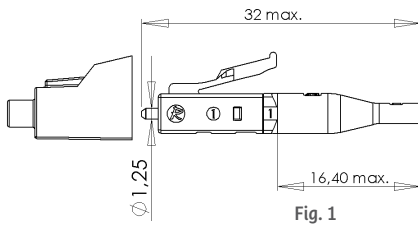

Fig. 1

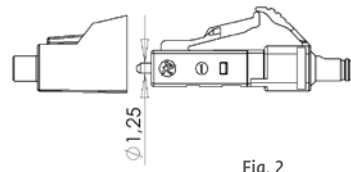
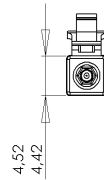

Fig. 2

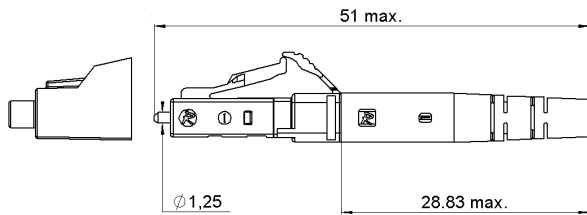
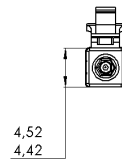

Fig. 3



Cable Diameter	Figure	SingleMode PC 126µm - Blue	SingleMode APC 126µm - Green	MultiMode PC 128µm - Beige	MultiMode PC 128µm - Aqua	Packaging
0.9 mm	Fig 1	F727 102 100	F727 152 100	F727 103 100	F727 103 110	100
Level "0" ⁽¹⁾ for 2 or 3 mm	Fig 2	F727 102 000	F727 152 000	F727 103 000	-	100
2 mm	Fig 3	F727 102 500	F727 152 500	F727 103 500	F727 103 510	100
3 mm		F727 102 700	F727 152 700	F727 103 700	F727 103 710	100

⁽¹⁾The level "0" is supplied without boots or crimp sleeves. To complete your connector assembly kit, please refer to the accessories chapter at the end of this section. Level "0" for 0.9 mm cable is available upon request.

Flexible configuration of simplex connector using level "0" part numbers

For 0.9 mm cable diameter

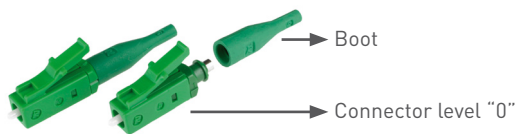

For 2 or 3 mm cable diameter

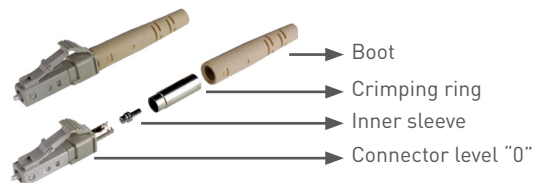

To get more information on how to find the corresponding part numbers and connector kit combination, please refer to the LC kit configurator section.

LC Series

APC 8° PRE-ANGLED SIMPLEX CONNECTORS

The APC version of the LC connector is also available in a pre-angled end face version for a fast polishing in the field and ultra-low back reflection.

Cable Diameter	Figure	SingleMode APC Pre-angled 126µm - Green	Packaging
0.9 mm		F727 132 100	100
2 mm		F727 132 500	100

DUPLEX LC CONNECTORS

Flexible Configuration with a Removable Duplex Clip:

Due to Radiall's LC removable duplex clip, a simplex connector can be changed into a duplex connector at any time. Select 2 Simplex LC connectors and a duplex removable clip to create your duplex LC connector. The duplex clip needs to be ordered separately. To select a clip, please refer to the accessories chapter at the end of this section.



Duplex LC with Non Removable Clip:

Radiall also provides "complete LC duplex" connectors. Being slightly smaller than the ones with the removable clip, they can be easily mounted into transceivers.



Cable Diameter	Figure	SingleMode PC 126µm - Blue	SingleMode APC 126µm - Green	MultiMode PC 128µm - Beige	Packaging
2 mm		F727 402 500	F727 452 500	F727 403 500	1
		F727 502 500	F727 552 500	F727 503 500	100
3 mm		F727 402 700	F727 452 700	F727 403 700	1
		-	-	F727 503 700	100

Note: Once assembled the brace is not removable.

LC Series

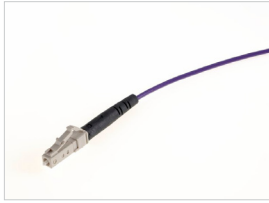

LC FOR HARSH ENVIRONMENTS

Radiall has enhanced the LC connectors to withstand harsh conditions for Mil/Aero applications.



Values shown in the tables below are minimum performances. If requested, Radiall can perform additional tests to demonstrate the performance of its ruggedized LC.

CHARACTERISTICS AND PERFORMANCES
OPTICAL CHARACTERISTICS

	SingleMode UPC	SingleMode APC	MultiMode PC
Wavelength	1300 - 1550 nm		850 - 1300 nm
Insertion loss	Mean	0.10 dB	0.10 dB
	Standard deviation	0.05 dB	0.05 dB
Return loss	> 50 dB	> 65 dB	> 20 dB

Insertion Loss against a reference patchcord: IEC 61300-3-4 Method B

Return loss: IEC 61300-3-6 (Maximum loss variation)

Note: the optical performances also depend on the fiber and/or cable construction.

MECHANICAL CHARACTERISTICS

	Cable Diameter: 1.8 – 2 mm
Cable retention	68 N
Mechanical endurance	500 matings
Vibration (EN 2591-403)	27.7 grms
Mechanical shocks (EN2591-402)	50 g, 11 ms

ENVIRONMENTAL CHARACTERISTICS

Operating temperature Thermal shocks (EN 2591-305)	-55°C / +125°C
Storage Temperature	-55°C / +125°C*

*Excludes cap and packaging

LC CONNECTORS

Cable diameter	Figure	SingleMode PC 126µm - Blue	SingleMode APC 126µm - Green	MultiMode PC 128µm - Beige	Packaging
1.8 - 2 mm Loose structure* Pull-proof design		F727 002 500Y	F727 052 500Y	F727 003 500Y	1
1.8 - 2 mm Tight structure* Non pull-proof design		F727 002 520Y	F727 052 520Y	F727 003 520Y	1

*See cable structure definitions in section 12, technical information, or in ARINC 802 specifications.

DUPLEX REMOVABLE CLIP

	Color	Part Number	Packaging	Picture
LC duplex removable clip	Beige	F718 197 006Y	1	

LC Series

LC ADAPTERS

Simplex Adapters

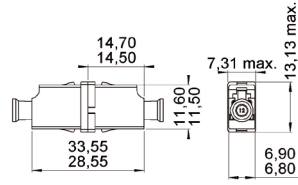

Fig. 1

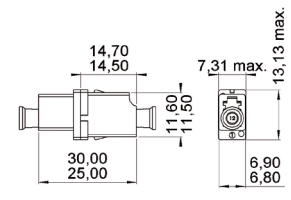

Fig. 2

Figure	SingleMode PC Blue	SingleMode APC Green	MultiMode PC Beige	MultiMode PC Aqua	Adapter Type	Alignment Sleeve	Packaging
Fig 1	F727 710 000	F727 710 100	F727 710 700	F727 710 710	LC cut-out Snap-in mounting	Zirconia	100
Fig 2	F727 711 000	F727 711 100	F727 711 700	F727 711 710	LC and low profile cut-out Snap-in mounting		

Duplex Adapters

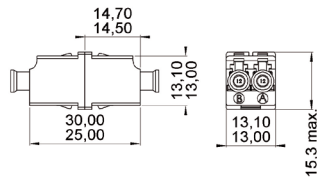

Fig. 1

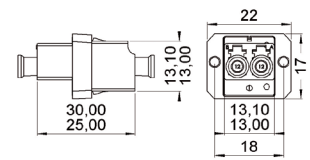

Fig. 2

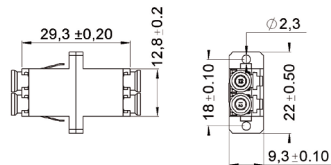

Fig. 3

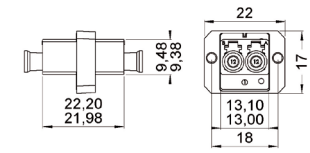

Fig. 4

Figure	SingleMode PC Blue	SingleMode APC Green	MultiMode PC Beige	MultiMode PC Aqua	Adapter Type	Alignment Sleeve	Packaging
Fig 1	F727 750 000	F727 750 100	F727 750 700	-	RJ-45 cut-out Snap-in mounting	Zirconia	100
	-	-	F727 750 800	-		PH/BR	100
Fig 2	F727 751 000	F727 751 100	F727 751 700	-	RJ-45 and low profile cut-out	Zirconia	100
Fig 3	F727 752 000	F727 752 100	-	F727 752 710	SC cut-out with panel clip	Zirconia	100
	-	-	F727 752 800	F727 752 810		PH/BR	100
Fig 4	F727 754 000	F727 754 100	F727 754 700	F727 754 710	SC RJ-45 cut-out with panel clip	Zirconia	100

SC Series



FEATURES AND BENEFITS

Easy Mounting and Installation

- Push-pull mechanism for fast and easy insertion and extraction
- 8° pre-angled APC version is available to ease and speed up the installation in the field
- Proprietary secure bonding to protect the floating mechanism during the resin injection process
- Color coding for easy identification

High Performance

- High precision alignment with proven 2.5 mm zirconia ferrule
- APC polishing available (RL>65dB)

Secure Connection

- Spring loaded mechanism
- Pull-proof design with loose structure configuration to guarantee no optical disconnection when pulling on the cable
- Radiall has improved the crimping reliability by using a mini metallic tube to protect the fiber, reduce stress and ensure an excellent cable retention

Versatile

- Adapted to MultiMode or SingleMode, PC, UPC and APC polishing.
- Available in duplex configurations by using a fully removable duplex brace.
- Various protection boots available with exclusive shapes to tighten the cable and maintain high optical performance even when the cable is bent or pulled.

SC STANDARD CHARACTERISTICS & PERFORMANCES

OPTICAL CHARACTERISTICS

	SingleMode PC	SingleMode APC	MultiMode PC
Wavelength	1310-1550 nm		850-1300 nm
Insertion Loss			
Mean	< 0.20 dB	< 0.20 dB	< 0.20 dB
Standard deviation	0.14 dB	0.15 dB	0.08 dB
Return Loss	> 50 dB	> 65 dB	20 dB

Insertion Loss against a reference patchcord: IEC 61300-3-4 Method B

Return Loss: IEC 61300-3-6

Note: The optical performances also depend on the fiber and/or cable construction.

MECHANICAL CHARACTERISTICS

	Cable Diameter 2 & 3 mm
Cable retention	100N
Mechanical endurance	200 matings

ENVIRONMENTAL CHARACTERISTICS

Operating temperature	-40°C / + 85°C
Storage temperature	-40°C / +85°C

MATERIALS

Molded plastic parts	V0 (UL 94)
Optical ferrule (connector)	Zirconia
Alignment sleeve (adapter)	Zirconia

SC Series

SIMPLEX SC CONNECTORS



The simplex SC connectors are delivered with straight boots, dust caps and crimping accessories, except for the level “0” categories which enable users to configure their own connectors according to their specific application.

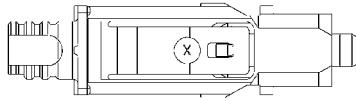

Fig. 1

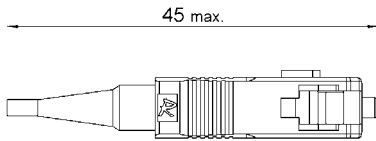
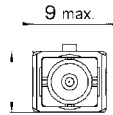

Fig. 2



7,4 max.

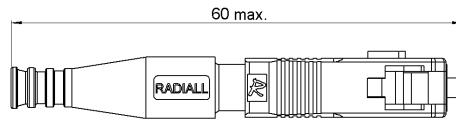
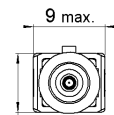
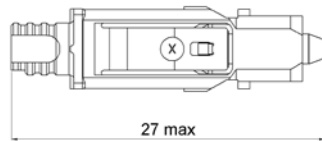

Fig. 3



7,4 max.

For APC applications, the ferrule extremity is conical to facilitate the angled polishing.



← Conical ferrule

Cable Diameter	Figure	SingleMode PC 126µm - Blue	SingleMode APC 126µm - Green	MultiMode PC 126µm - Beige	MultiMode PC 128µm - Aqua	Packaging
Level "0" ⁽¹⁾	Fig 1	F728 102 000	F728 112 000	F728 103 000	-	100
0.9 mm	Fig 2	F728 002 100	F728 012 100	F728 003 100	-	1
		F728 102 100	F728 112 100	F728 103 100	F728 103 101	100
2 mm	Fig 3	F728 002 500	F728 012 500	F728 003 500	-	1
		F728 102 500	F728 112 500	F728 103 500	F728 103 501	100
3 mm	Fig 3	F728 002 700	F728 012 700	F728 003 700	-	1
		F728 102 700	F728 112 700	F728 103 700	F728 103 702	100

⁽¹⁾The level “0” is supplied without boots or crimp sleeves. To complete your connector assembly kit, please refer to the accessories chapter at the end of this section.

Flexible configuration of simplex connector using level "0" Part Numbers

For 0.9 mm cable diameter

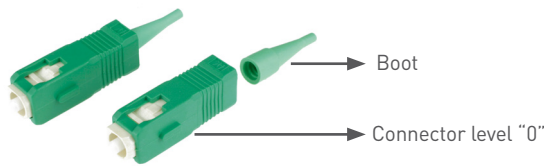

For 2 or 3 mm cable diameter

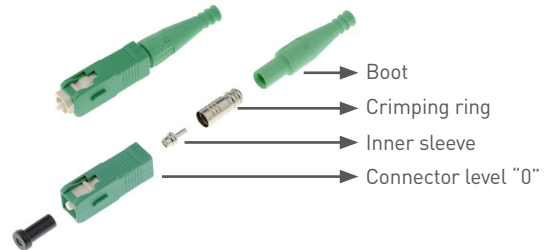

To get more information on how to find the corresponding part numbers and connector kit combination, please refer to the SC kit configurator section.

SC Series

APC 8° PRE-ANGLED SIMPLEX CONNECTORS



The APC version of the SC connector is also available in a pre-angled end face version for a fast polishing in the field and ultra-low back reflection.

Cable Diameter	Figure	SingleMode APC Pre-angled 126µm - Green	Packaging
0.9 mm		F728 132 100	100
3 mm		F728 132 700	100

DUPLEX SC CONNECTORS

With Radiall's SC removable duplex clip, a simplex connector can be changed into a duplex connector at any time. The clip is fixed after cabling. Select 2 Simplex SC connectors and a duplex removable clip to create your duplex SC connector. The identification of the optical channel (A or B) can be easily changed by reversing the clip cover.



To select a clip, please refer to the accessories chapter at the end of this section.

SC Series



SC FOR HARSH ENVIRONMENTS

Radiall has enhanced the SC connectors to withstand harsh conditions of Mil/Aero applications.



Values shown in the tables below are minimum performances. If requested, Radiall can perform additional tests to demonstrate the performance of its ruggedized SC.

CHARACTERISTICS AND PERFORMANCES

OPTICAL CHARACTERISTICS

	MultiMode PC
Wavelength	850-1300 nm
Insertion Loss	
Mean	< 0.20 dB
Standard deviation	0.08 dB
Return Loss	> 20 dB

Insertion Loss against a reference patchcord: IEC 61300-3-4 Method B

Return Loss: IEC 61300-3-6

Note: the optical performances also depend on the fiber and/or cable construction.

MECHANICAL CHARACTERISTICS

	Cable Diameter 1.8 - 2mm
Cable retention	68N
Mechanical endurance	200 matings

ENVIRONMENTAL CHARACTERISTICS

Operating temperature thermal shocks [EN 2591-305]	-55°C / +125°C
Storage Temperature	-55°C / +125°C*

*Excludes cap and packaging

SC CONNECTORS

Cable Diameter 1.8 - 2mm	Figure	MultiMode PC	Packaging
1.8 - 2 mm Loose structure* Pull-proof design		F728 003 500Y	1
1.8 - 2 mm Tight structure* Non pull-proof design		F728 003 520Y	1

*See cable structure definition in the glossary or in ARINC 802 specification.

For other cable diameters and SingleMode PC and APC configurations, please contact your local Radiall representative.

SC Series

SC ADAPTERS

SC adapters are available for snap-in or flange screw-in mounting. Color coding remains the same as the connector coding:

- SingleMode PC: Blue
- SingleMode APC: Green
- MultiMode PC: Beige
- MultiMode PC with OM3 fiber: Aqua

Simplex Adapters

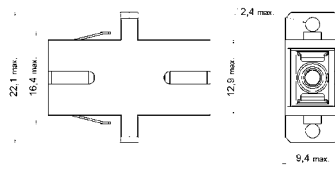

Fig. 1

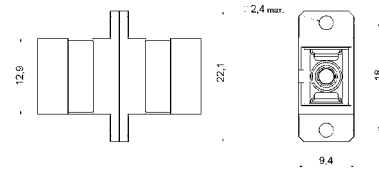

Fig. 2

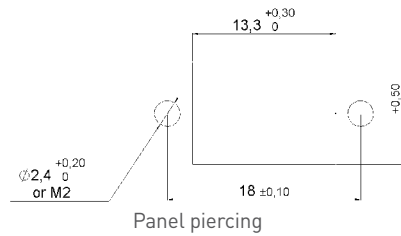

Figure	SingleMode PC Blue	SingleMode APC Green	MultiMode PC Beige	MultiMode PC Aqua	Alignment Sleeve	Adapter Type	Packaging
Fig 1	F728 703 000	F728 703 100	F728 703 700	-	Zirconia ceramic	Snap in	1
	F728 713 000	F728 713 100	F728 713 700	F728 713 701			100
Fig 2	F728 700 000	F728 700 100	F728 700 700	-	Zirconia ceramic	Screw in	1
	F728 710 000	F728 710 100	F728 710 700	-			100

Duplex Adapters

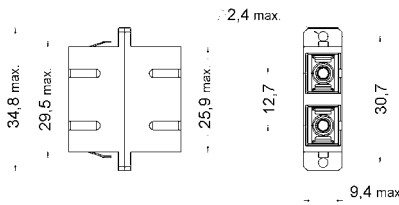

Fig. 1

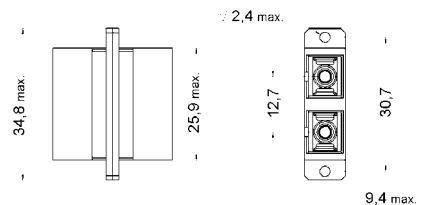

Fig. 2

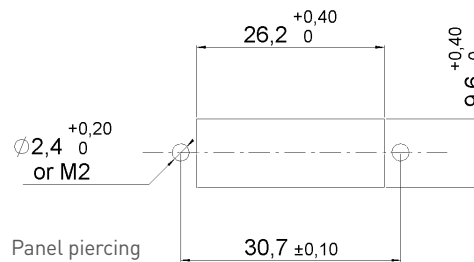

Figure	SingleMode PC Blue	SingleMode APC Green	MultiMode PC Beige	MultiMode PC Aqua	Alignment Sleeve	Adapter Type	Packaging
Fig 1	F728 743 000	F728 743 100	F728 743 700	-	Zirconia ceramic	Snap in	1
	F728 753 000	F728 753 100	F728 753 700	F728 753 701			100
Fig 2	F728 750 000	F728 750 100	F728 750 700	-	Zirconia ceramic	Screw in	100

ST Series



FEATURES AND BENEFITS

Secure Connection

- Bayonet locking system for a fast and easy setup
- Spring loaded mechanism
- ST's key prevents rotation of the ceramic ferrule
- Nickel-plated housing for a robust connection
- High precision alignment with 2.5 mm zirconia ceramic ferrule

Versatile

- Standard or secure crimping (double ferrule)
- Sealed version for use in humid or wet environment (IP64)
- ST connector available for harsh environment applications
- Available in MultiMode and SingleMode configurations
- Available for various fiber and cable diameters

ST STANDARD CHARACTERISTICS AND PERFORMANCES

OPTICAL CHARACTERISTICS

	SingleMode PC	MultiMode PC
Wavelength	1310-1550 nm	850 nm
Insertion loss		
Mean	< 0.25 dB	< 0.25 dB
Standard deviation	0.11 dB	0.11 dB
Return loss	> 50 dB	> 20 dB

Insertion Loss against a reference patchcord: IEC 61300-3-4 Method B

Return loss: IEC 61300-3-6

Note: The optical performances also depend on the fiber and/or cable construction.

MECHANICAL CHARACTERISTICS

	Cable Diameter 2 & 3 mm
Cable retention	100N
Mechanical endurance	500 matings

ENVIRONMENTAL CHARACTERISTICS

Operating temperature	-40°C / +85°C
Storage temperature	-40°C / +85°C

MATERIALS

Molded plastic parts	V1 (UL 94)
Body	Brass, nickel plated
Alignment sleeve (adapter)	Zirconia

ST Series



ST CONNECTORS

The ST connectors are delivered with straight black boots, dust caps and crimping accessories, except for the level "0" categories which enable users to build their own connectors according to their applications. The ST series also includes an enhanced version of the ST connector which features a secure crimping device and configuration specific for harsh environments.

The secure crimping device enables aramids strength members and the outer jacket of the fiber to be held together simultaneously and allow for reliable protection of the fiber against the crimping stress.

Standard crimping

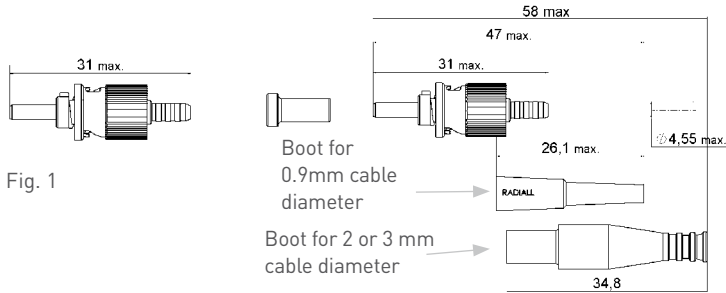

Fig. 1

Fig. 2

Secure crimping

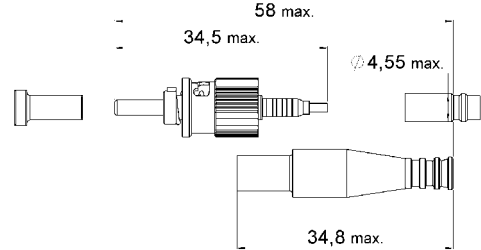

Fig. 3

Cable diameter	Figure	Standard Crimping			Secure Crimping		Packaging
		SingleMode PC 126µm	MultiMode PC 128µm	MultiMode PC 140µm	SingleMode PC 126µm	MultiMode PC 128µm	
Level "0" ⁽¹⁾	Fig 1	F709 036 200	F709 025 200	-	-	-	100
0.9 mm	Fig 2	F709 034 706 ⁽²⁾	F709 022 000	F709 090 000 ⁽²⁾	-	-	1
		F709 034 200 ⁽²⁾	F709 022 200	-	-	-	100
2 mm	and	-	-	-	-	F709 097 200	100
3 mm	Fig 3	F709 034 706 ⁽²⁾	F709 024 000 ⁽²⁾	F709 090 000 ⁽²⁾	-	-	1
		F709 034 200 ⁽²⁾	F709 024 200 ⁽²⁾	-	F709 096 200	F709 098 200	100

⁽¹⁾The level "0" is supplied without boots or crimp sleeves. To complete your connector assembly kit, please refer to the accessories section.

⁽²⁾2 Boots are delivered with this PN
For other cable diameters, please contact your local Radiall representative.

Flexible Configuration Using Level "0" Part Numbers:

For 0.9 mm cable diameter

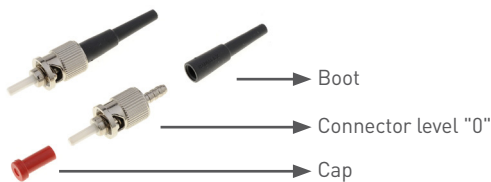

For 2 or 3 mm cable diameter

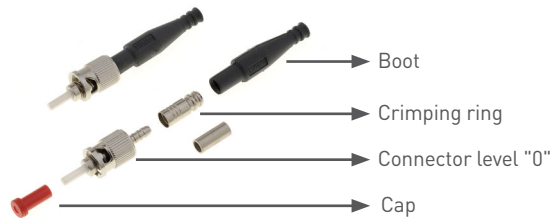

To get more information on how to find the corresponding part numbers and connector kit combination, please refer to the ST kit configurator at the end of this section.

ST Series



ST SEALED CONNECTION

Radiall also offers an ST connector with a specific design which ensures a reliable connection even in wet environments.

By combining the sealed connector and adapter, you'll get a fully sealed IP64 connection for operations in all climatic conditions (rain, snow, etc., except immersion).

FEATURES AND BENEFITS

Secure crimping

Effective protection in wet environment

Bayonet locking system

Pre-radius MultiMode zirconia ceramic ferrule

Outside boot providing the sealing of the complete connection, IP64

By adding an internal gasket on the bulkhead adapter and an outside boot, the sealing is guaranteed on 3 points of the connection:

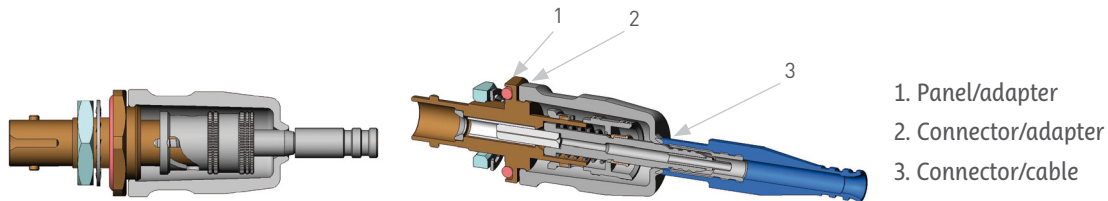

HOW TO ORDER

ST Sealed Connectors

	Figure	MultiMode PC 128µm	Cable dia.	Packaging
		F709 089 000	2.7 mm to 3 mm	1

ST Sealed Adapter

The sealed adapter has been designed to be used with the sealed connector F709 089 000 to guarantee a completely sealed connection.

	Figure	Part Number	Alignment sleeve	Packaging
		F709 724 000	Zirconia ceramic	1

Note: the sealed connector and adapter cannot be combined with non-sealed versions.

ST Series



ST FOR HARSH ENVIRONMENTS

The ruggedized ST is a IEC 61754-2 type connector dedicated to Mil/Aero applications with a bayonet locking system. This ST configuration is also available for tight structure cables specific for Mil/Aero applications.



CHARACTERISTICS AND PERFORMANCES

	MultiMode PC
Wavelength	850-1300 nm
Insertion Loss	Mean
	Standard deviation
Return Loss	> 20 dB

Insertion Loss against a reference patchcord: IEC 61300-3-4 method B

Return loss: IEC 61300-3-6 (Maximum loss variation)

Note: the optical performances also depend on the fiber and/or cable construction.

MECHANICAL CHARACTERISTICS

	Cable Diameter: 1.8 max.
Cable retention	100N
Mechanical endurance	500 matings

ENVIRONMENTAL CHARACTERISTICS

Operating temperature thermal shocks (EN 2591-305)	-55°C / +125°C
Storage temperature range	-55°C / +125°C*

*Excludes cap and packaging

HOW TO ORDER

Cable Diameter	Figure	MultiMode PC	Packaging
1.8 - 2 mm Loose structure* Pull-proof design		F709 020 100Y	1
1.8 - 2 mm Tight structure* Non pull-proof design		F709 150 000Y	1

*See cable structure definition in the glossary or in ARINC 802 specification.

ST Series

ST RECEPTACLES

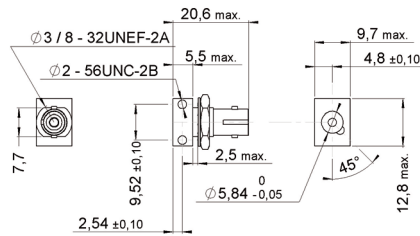

Fig. 1

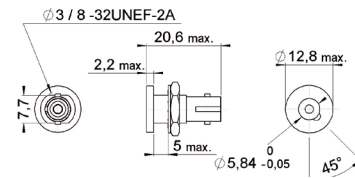
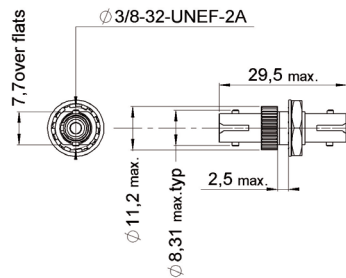

Fig. 2

Part Number	Figure	Description	Note	Panel Piercing	Packaging
F709 400 000	Fig 1	Bulkhead or PCB mounting	Metal body, supplied with 2 centering rings		1
F709 401 000	Fig 2	Bulkhead mounting			1

ST ADAPTERS

The ST adapter features a bayonet coupling system to secure the connection with the ST connectors. The alignment sleeve is available in zirconia ceramic or in phosphor bronze and works for SingleMode or MultiMode fibers.



Part Number	Alignment Sleeve	Panel Piercing	Packaging
F709 730 000	Zirconia ceramic		1
F709 730 200			100
F709 722 000	Phosphor bronze		1
F709 722 200			100

Accessories for LC, SC and ST Series

DUPLEX REMOVABLE CLIPS

Series	Figure	SingleMode APC - Green	SingleMode PC - Blue	MultiMode Beige	Black	Packaging
LC		F718 197 205	F718 197 201	F718 197 206	F718 197 200	100
SC		F718 102 000	F718 101 000	F718 100 000	-	

INNER SLEEVES

Series	Figure	Cable dia.	Part number	Packaging
LC		2 & 3 mm	F718 158 200	100
SC		1.6 mm to 3 mm	F718 106 200	

Accessories for LC, SC and ST Series

CRIMPING RINGS

Series	Figure	Cable Diameter	Part Number	Packaging
LC		2mm	F718 160 200	100
		2.4mm	F718 175 200	
		3mm	F718 170 200	
SC		2mm	F718 109 200	
		2.4mm	F718 108 200	
		3mm	F718 107 200	
ST		2mm	F718 146 200	
		2.4mm	F718 069 000	
			F718 145 200	

CONNECTOR CAPS



Fig. 1



Fig. 2



Fig. 3



Fig. 4



Fig. 5

Picture	Description	Series	Part Number	Packaging
Fig. 1	Metal protective cap	ST adapters and receptacles	F709 760 000	1
Fig. 2	Safety plastic cap	ST connectors	F718 044 000	20
Fig. 3	Clipped plastic dust cap	LC connectors	F718 183 204	100
Fig. 4	Metal dust cap	ST connectors	F709 750 000	20
Fig. 5	Universal, plastic dust cap	SC, ST connectors and all connectors with 2.5 mm optical ferrule	F718 111 220	20

Accessories for LC, SC and ST Series

BOOTS

Radiall manufactures and offers a wide range of boots supporting multiple connector types. Different boots are available to protect the fiber while providing enough flexibility when handling the fiber cable.

LC SUPER FLEXIBLE BOOTS



Super flexible boots are specifically recommended when space is limited and when a small bending radius is required (min radius 20 mm). They prevent any damage to the fiber even in case of low bend radius. These boots are available in various colors.

Figure	Color	Flexible Boots	Cable Dia.	Packaging
	Black	F718 207 200	2 mm	100
	Blue	F718 207 201		
	Yellow	F718 207 202		
	Red	F718 207 203		
	White	F718 207 204		
	Green	F718 207 205		
	Aqua	F718 207 209		

Bending Radius Comparison

With its specific design, the super flexible boot can reduce the bending radius up to two times of a standard straight boot. They provide remarkably small bend radii with minimum losses.

Note: The bending radius is cable dependent.

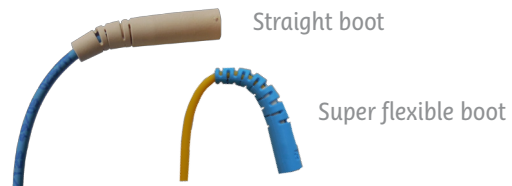

LC STRAIGHT BOOTS



Boots are available in various colors and dimensions depending on the requirements.

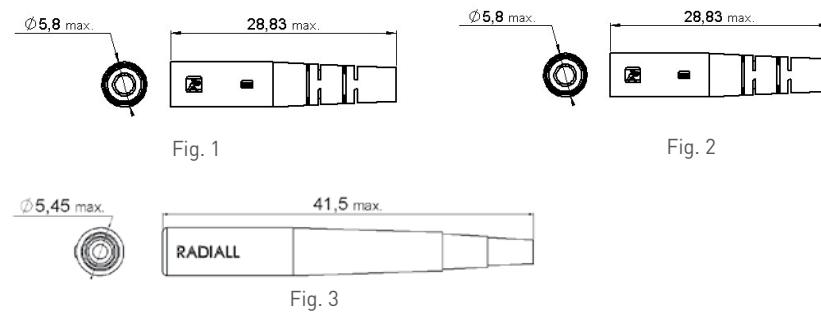

Color	Cable Diameter				Packaging
	0.9 mm Fig 1	2 mm Fig 2	3 mm Fig 2	Universal boot for 2/3 mm Fig 3	
Black	F718 166 200	F718 162 200	F718 193 200	F718 169 200	100
Blue	F718 166 201	F718 162 201	F718 193 201	F718 169 201	
Yellow	F718 166 202	F718 162 202	-	F718 169 202	
Red	F718 166 203	F718 162 203	F718 193 203	F718 169 203	
White	F718 166 204	F718 162 204	F718 193 204	F718 169 204	
Green	F718 166 205	F718 162 205	F718 193 205	F718 169 205	
Beige	F718 166 206	F718 162 206	F718 193 206	F718 169 206	
Aqua	F718 166 209	F718 162 209	F718 193 209	-	

Accessories for LC, SC and ST Series

LC ANGLED BOOTS

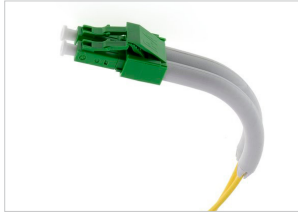

Available in short and long versions, angled boots are rigid and specifically designed to adapt to limited access environments. They can be mounted in a stackable position when operating in dense circuitry. They can also be combined to be used in duplex configurations.

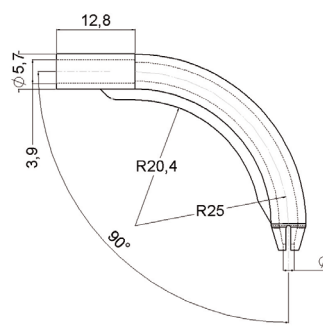
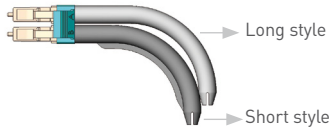

Fig. 1

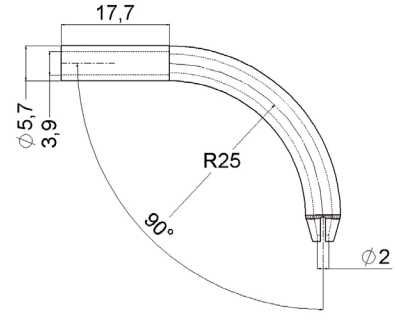

Fig. 2

Cable dia.	Figure	Part Number	Description	Packaging
2 mm	Fig 1	F718 185 200	90° short style, grey color	100
	Fig 2	F718 186 200	90° long style, grey color	100

SC ST BOOTS

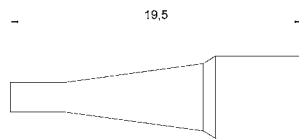

Fig. 1

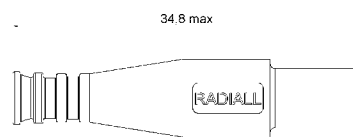

Fig. 2

Color	Cable Diameter			Packaging
	0.9 ⁽¹⁾ mm Fig 1	2 to 2.4 ⁽²⁾ mm Fig 2	2.7 to 3 ⁽²⁾ mm Fig 2	
Black	F718 105 200	F718 104 200	F718 103 200	100
Blue	F718 105 201	F718 104 201	F718 103 201	
Yellow	F718 105 202	F718 104 202	F718 103 202	
Red	F718 105 203	F718 104 203	F718 103 203	
Green	F718 105 205	F718 104 205	F718 103 205	
Beige	F718 105 206	F718 104 206	F718 103 206	
Aqua	F718 105 210	F718 104 210	F718 103 210	

⁽¹⁾These references apply to SC and FC connectors

⁽²⁾These references apply to SC, FC and ST connectors

Connector Kit Configurators

LC KIT CONFIGURATOR

You can refer to this table and build your own connector by combining different accessories with level "0" LC connector.

Cable Dia.	2 mm			3 mm		
Fiber Type	SingleMode PC	SingleMode APC	MultiMode PC	SingleMode PC	SingleMode APC	MultiMode PC
Body Color	Blue	Green	Beige	Blue	Green	Beige
Level "0"	F727 102 000	F727 152 000	F727 103 000	F727 102 000	F727 152 000	F727 103 000
Inner Sleeves	F718 158 200			F718 158 200		
Crimping Ring	F718 160 200			F718 170 200		
Straight Boot	F718 162 20x ⁽¹⁾			F718 193 20x ⁽¹⁾		
	Your final connector kit					

⁽¹⁾Replace x with the following digit for your color reference: 0: black; 1: blue; 2: yellow; 3: red; 4: white; 5: green; 6: beige; 9: aqua

Notes: Refer to previous pages for angled or super flexible boot selection.

Connector Kit Configurators

SC KIT CONFIGURATOR

You can refer to this table and complete your connector by combining different accessories with level "0".

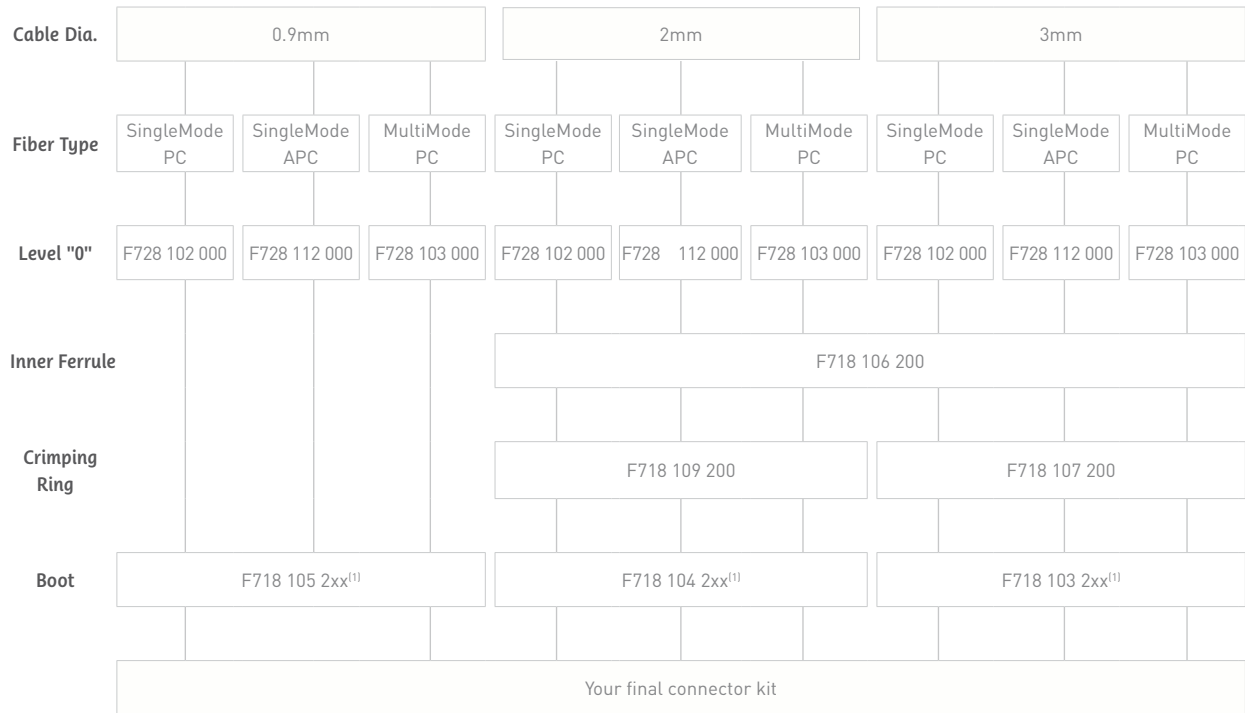

⁽¹⁾Replace x with the following digit for your color reference: 00: black; 01: blue; 02: yellow; 03: red; 05: green; 06: beige; 10: aqua

ST KIT CONFIGURATOR

You can refer to this table and complete your connector by combining different accessories with level "0".

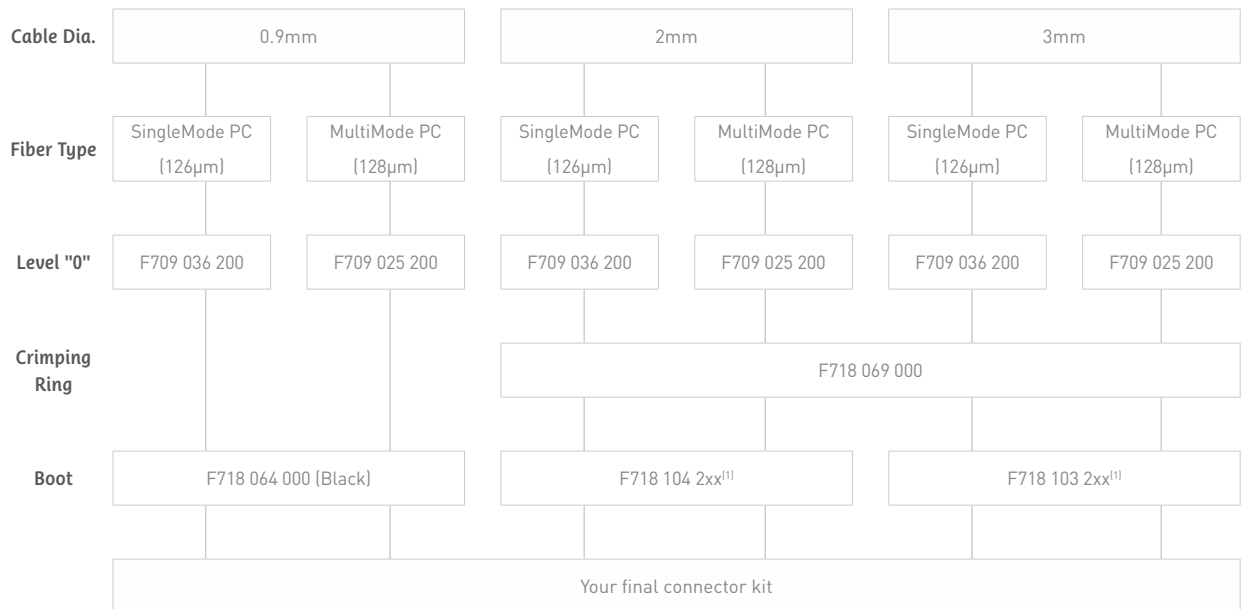

⁽¹⁾Replace x with the following digit for your color reference: 00: black; 01: blue; 02: yellow; 03: red; 05: green; 06: beige; 10: aqua

Notes

SECTION 5



RXF Series



Contents

Introduction	
RXF: Radiall Outdoor Fiber Optic Connector	5-2
Applications	5-2
International Standard Documents Compliance	5-2
Features and Benefits	5-2
Characteristics	
Optical Characteristics	5-3
Mechanical Characteristics	5-3
Environmental Characteristics	5-3
Materials	5-3
RXF Product Range	
R2F: Two Fiber Optic Channels	5-4
R4F: Four Fiber Optic Channels	5-5
R6F: Six Fiber Optic Channels	5-6
Dimensions	
RXF Plugs	5-7
RXF Sockets	5-7
Captive Protection Caps	5-8
Cleaning Tool	5-8
RXF Cable Assemblies	5-9
RXF Connector Kits	5-10

Introduction

RXF: RADIALL OUTDOOR FIBER OPTIC CONNECTOR



Dedicated to outdoor optical connections, RXF has been designed and is manufactured by Radiall.

RXF connectors are available within 2, 4 and 6 channels, in MultiMode or SingleMode UPC versions.

RXF can be provided as complete cable assemblies or connector kits depending on the customer need.

A quick-locking device with IP68 sealing and low loss insertion allows this connector to be used in severe outdoor conditions and harsh environments.

APPLICATIONS

Wireless communications

Energy

Transportation

Monitoring display

INTERNATIONAL STANDARD DOCUMENTS COMPLIANCE

- IEC 61300 Fiber optic interconnecting devices and passive components
- Telcordia GR-326-CORE Optical connectors and Jumpers assemblies
- IEC 60529 Degrees of protection provided by enclosures (IP code)
- EN 50125 Railway applications – environmental conditions for equipment
- MIL-PRF-39012 Standard N type mechanical interface
- RoHS compliant



FEATURES AND BENEFITS

Robust connection

- Fully protected ceramic ferrules and alignment sleeves: no risk to damage the optical faces during mounting/dismounting operations
- Standard mechanical interface: N type screwing according to MIL-PRF-39012
- Use of standard optical ferrules 1.25 mm

Easy Installation

- Qualified with other compatible outdoor fiber optic N type connectors
- Screwed locking mechanism: easy to install (U-19 mm wrench/1 N.m torque)
- Fast and easy connection: one-hand blind mate coupling

Resistant in harsh environments adapted for outdoor use

- Waterproof connection
- Dust proof
- Corrosion resistant

High level of performances

- Full compliance to IEC 61300 standard
- High tensile strength
- EMI immunity



Characteristics

OPTICAL CHARACTERISTICS

Insertion Loss (IEC 61300-3-4)	typical<0.2 dB (max<0.5 dB)
Return Loss	>50 dB

Insertion Loss against a reference patchcord: IEC 61300-3-4 Method B

Return Loss: IEC 61300-3-6

Note: The optical performances also depend on the fiber or cable intrinsic qualities.

MECHANICAL CHARACTERISTICS

Mating endurance	IEC 61300-2-2	500 mating cycles minimum
Tensile resistance	RXF Plug	800 N (with field cable)*
	RXF Socket	30 N (with field cable)*
Vibrations	IEC 61300-2-1	passed
Shocks	IEC 61300-2-9	passed

*Depending on cable type

ENVIRONMENTAL CHARACTERISTICS

Operating temperature range	IEC 61300-2-22	-40°C/+85°C
Salt spray	IEC 61300-2-26	passed
Ingress protection class	IEC 60529	IP 68 (with screwed cap or when mated)





MATERIALS

Housing	Brass
Plating	Nickel







RXF Product Range

R2F: TWO FIBER OPTIC CHANNELS

Connector	Mode	Type and Cable	
R2F Plug	MM/SM	Standard Type (outdoor field cable)	
R2F Socket Extender	MM/SM	Standard Type (outdoor field cable)	
R2F Socket	MM/SM	Square flange SMALL Size 25.4x25.4 mm (indoor cable)	
		Square flange LARGE size 32x32 mm (indoor cable)	
		Hexagonal flange (30 mm on flats) D-hole thread M22x1 (indoor cable)	

RXF Product Range



R4F: FOUR FIBER OPTIC CHANNELS

Connector	Mode	Type and Cable	
R4F Plug	MM/SM	Standard type (outdoor field cable)	
R4F Socket Extender	MM/SM	Standard type (outdoor field cable)	
R4F Socket	MM/SM	Square flange SMALL size 25.4x25.4 mm (indoor cable)	
		Square flange LARGE size 32x32 mm (indoor cable)	
		Hexagonal flange (30 mm on flats) D-hole thread M22x1 (indoor cable)	

RXF SERIES

RXF Product Range

R6F: SIX FIBER OPTIC CHANNELS

Connector	Mode	Type and Cable	
R6F Plug	MM/SM	Standard type (outdoor field cable)	
R6F Socket	MM/SM	Standard type (outdoor field cable)	

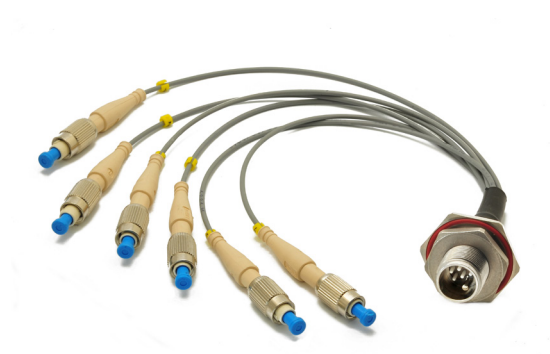

Dimensions





RXF PLUGS

R2F Plug		<p>3D view</p>
R4F Plug		<p>3D view</p>

RXF SOCKETS

R2F Socket Square Flange Small Size			<p>panel pattern</p>	
R2F Socket Square Flange Large Size			<p>panel pattern</p>	
R2F Socket Hexagonal Flange			<p>Panel Pattern</p>	<p>3D view</p>
R2F Socket Extender			<p>3D view</p>	
R4F Socket Hexagonal Flange		<p>from 2.8mm to 4mm (panel thickness)</p>	<p>3D view</p>	

Captive Protection Caps

Description	IP Class	
Vinyl Dust Cap	IP65	
Metallic Protection Cap with Chain	IP67	
Plastic Protection Cap	IP67	
Plastic Protection Cap with Chain	IP67	

Cleaning Tool



Mechanical cleaning tool to clean RXF optical end-faces.
The tool uses a dry cleaning strand to gently sweep and lift away dust and residue from the connector end-face.

Part Number	Description	Packaging
F780 073 000	RXF Cleaning Tool	Unitary

RXF Cable Assemblies

Radiall can accommodate different types of cables (simplex or field cables) and various diameters. The cable assemblies will be customized to fit with particular application requirements (specific labeling, length, etc.) and will be tested before shipment. Radiall's assembly shops have mass production capacity and can adapt to low and high volume requirements.

Standard Configuration:

Please refer to Section 9, Cable Assemblies & Optical Systems, for more information.

RXF CABLE ASSEMBLY SERVICE OFFER

Existing Customer Specification:

Radiall will provide a compliance matrix for validation.

Define your Cable Assemblies:

- 1-series (R2F, R4F or R6F)
 - 2-connector 1 + protection cap
 - 3-connector 2 + protection cap
 - 4-fiber type/cable
 - 5-length (in meters and in millimeters)
- Radiall will provide a TDS for validation.



RXF Connector Kits

Radiall also proposes the RXF connectors in standalone kits: plugs and sockets can be ordered (without cable).

This product offer is dedicated to customers, such as cable assemblies makers, with very good know-how and experience in fiber optics cabling. Due to specific toolings and training needed to cable the RXF, a minimum potential volume of pieces is required to be able to have access to this offer.

For any additional information, please contact your local Radiall representative.

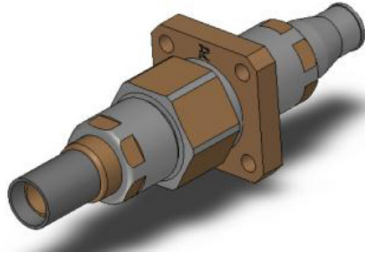

SECTION 6



R2CT® Series



Contents

Introduction	
R2CT®: Radiall 2 Connectors to Transceiver	6-2
Applications	6-2
International Standard Documents Compliance	6-2
Features and Benefits	6-2
Characteristics	
Mechanical Characteristics	6-3
Environmental Characteristics	6-3
Product Range	
R2CT® Standard Plug Kit	6-4
R2CT® Short Plug Kit	6-5
R2CT® Standard Receptacle	6-6
R2CT® Receptacle With LC Adapter	6-7
R2CT® Field Adapter Plug-Plug	6-8
Tools and Accessories	
R2CT® Adapter N-RJ45	6-9
R2CT® Extension Kit	6-9
Cable Assemblies	
R2CT® Pre-mounted Optical Cable Assemblies	6-10
R2CT® Pre-mounted On RJ45 Cable Assemblies	6-10
Patchcords	6-11

Introduction

R2CT®: RADIALL 2 CONNECTORS TO TRANSCEIVER



The Most Flexible Outdoor Interconnection Solution

The R2CT® connection system is the most flexible outdoor interconnection solution that meets the needs of telecommunication OEMs and operators for Fiber-To-The-Antenna (FTTA) and similar multisignal applications in the field conditions.

At the panel front of the Remote Radio Head (RRH) and Unit (RRU) equipment, the R2CT® provides a simple and protected low-cost waterproof and sealed connection.

Designed firstly for optical links using SFP transceivers and duplex LC-terminated fiber-optic cable, this very flexible connector is also useful for electrical links.

APPLICATIONS

FTTA: Fiber To The Antenna

Outdoor Telecom

Industrial Connection



INTERNATIONAL STANDARD DOCUMENTS COMPLIANCE

- IEC 61300: Fiber optic interconnecting devices and passive components
- IEC 60068: Environmental testing
- IEC 60529: Degrees of protection provided by enclosures (IP code)
- RoHS compliant



FEATURES AND BENEFITS

Flexible and Modular

- Kit assembles in the field over existing optical patchcords
- Compatible with any standard optical LC field cable assembly
- Compatible with any standard SFP transceiver
- Reusable allowing cables and transceivers to be easily changed in the field, including front-panel swapping of transceivers
- R2CT® connection system can easily be used for other Ethernet and multisignal applications: compatible with RJ45 patchcords and USB connections

Robust and Easy to Install

- Double bayonet locking system ensures mechanical connection, allowing a tool less hand-tightened connection
- Kit assembled in the field without tools
- Designed to withstand climatic working conditions of outdoor field applications
- Plug assembly includes a protection cap that can be used for pulling cable

Mechanical and Environmental Protection

- Waterproof
- Dustproof
- Important tensile strength

Low Cost

Characteristics

R2CT® connector has been designed to fulfill the qualification requirements of IEC 61300 standard (for fiber optic interconnection devices)

MECHANICAL CHARACTERISTICS

Cable retention	200 N
Mating endurance	100 mating cycles minimum

ENVIRONMENTAL CHARACTERISTICS

Ingress protection class	IP65 or IP67
Operating temperature	-40°C/+85°C
Storage temperature	-40°C/+85°C
Salt mist	IEC 61300-2-26 passed
Vibrations	IEC 61300-2-1 passed

Product Range

R2CT® solution is available as a component (Plug Kit) to fit in the field on any conventional LC or SC optical connector or as a complete cable assembly.

A short version of the R2CT® Plug Kit has also been developed with reduced overall dimensions, which is especially well adapted to electrical links such as RJ45 connections or optical multichannel (MPO).

R2CT® STANDARD PLUG KIT

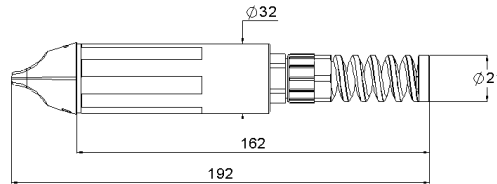

Part Number	Description	Packaging
R2CT 115 000	Plug connector only; no patchcord	Unitary in plastic bag with assembly note

The R2CT® Plug Kit is adapted to all types of optical cable assemblies with simplex or duplex LC connectors, simplex SC, and with 5 to 7 mm diameter MultiMode or SingleMode field cables.

To guarantee proper operation when the R2CT® Plug Kit is assembled over existing LC Duplex optical patchcords, the following fan-out dimensions should be observed:

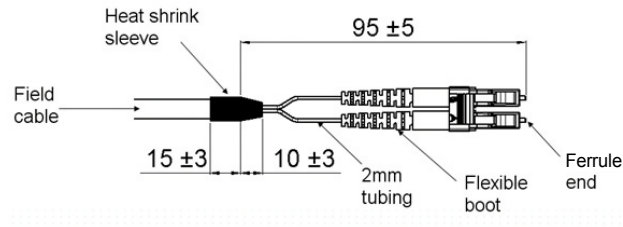

We recommend using a torque wrench (Radiall PN: R282 303 230) set at 3.5 to 4 Nm to guarantee 200 N tensile strength.

The standard R2CT® Plug Kit can also be used with existing SC simplex patchcords:



Product Range

R2CT® SHORT PLUG KIT

The R2CT® Short Plug Kit can fit with any type of electrical Ethernet RJ45 cables with diameters from 5 to 7 mm or optical multichannel MPO cable assemblies.

R2CT® Short Plug Kit connector exists in IP67 version or in IP65 version with split gasket for full assembly in the field.

It is delivered with a pulling nose which protects the connector interface and can include a disconnection clip to disconnect the RJ45 connector from its socket.

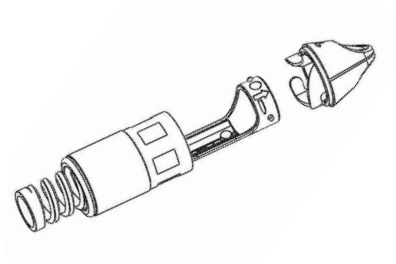
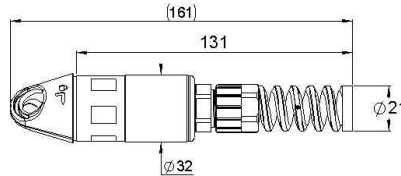

Figure 1

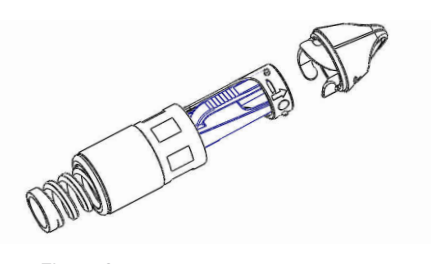

Figure 2

Part Number	Figure	Description	Packaging
R2CT 125 000	1	Kit IP65 Protection (no clip) Plug connector only; no patchcord	Unitary in plastic bag with assembly note
R2CT 125 001	2	Kit IP65 Protection With Disconnection Clip Plug connector only; no patchcord	
R2CT 127 000	1	Kit IP67 Protection (no clip) Plug connector only; no patchcord	
R2CT 127 001	2	Kit IP67 Protection With Disconnection Clip Plug connector only; no patchcord	

The R2CT® Short Plug Kit can be used easily for RJ45 or MPO connection links:



R2CT 127 001 mounted on RJ45 patchcord



R2CT 125 000 with MPO connection

Product Range

R2CT® STANDARD RECEPTACLE

Fixed to the panel of the equipment by four screws, the R2CT® standard receptacle allows an easy access to connect the signal to SFP transceivers for optical links or to RJ45 sockets for Ethernet links.

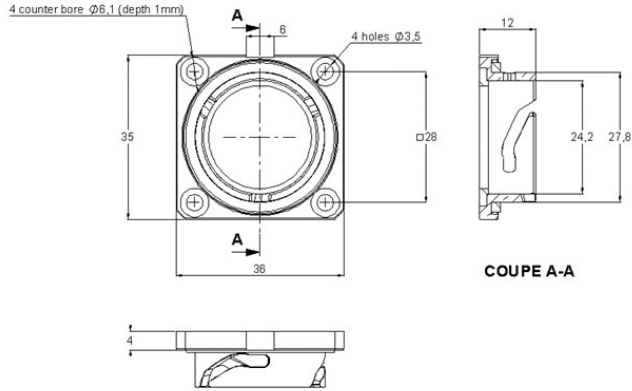

The R2CT® receptacle is supplied with the protection cap installed.
Two possible configurations: red vinyl cap (protection IP65) or aluminium protection cap (IP67).

	Part Number	Description	Panel Cut Out
	R2CT 105 000	Receptacle with red vinyl protection cap	
	R2CT 107 000	Receptacle with metal protection cap	<p>Clearance Holes for M3 Screws</p> <p>$\varnothing 22 \pm 0,1$</p> <p>$\square 28 \pm 0,1$</p>
	R2CT 107 018	Receptacle with metal protection cap with chain	

Product Range

R2CT® RECEPTACLE WITH LC ADAPTER

A variation of the R2CT® receptacle has been developed to include a LC adapter to allow the R2CT® interface to be used with equipment in which the SFP transceiver is inside the box (RRU of first generation, etc).

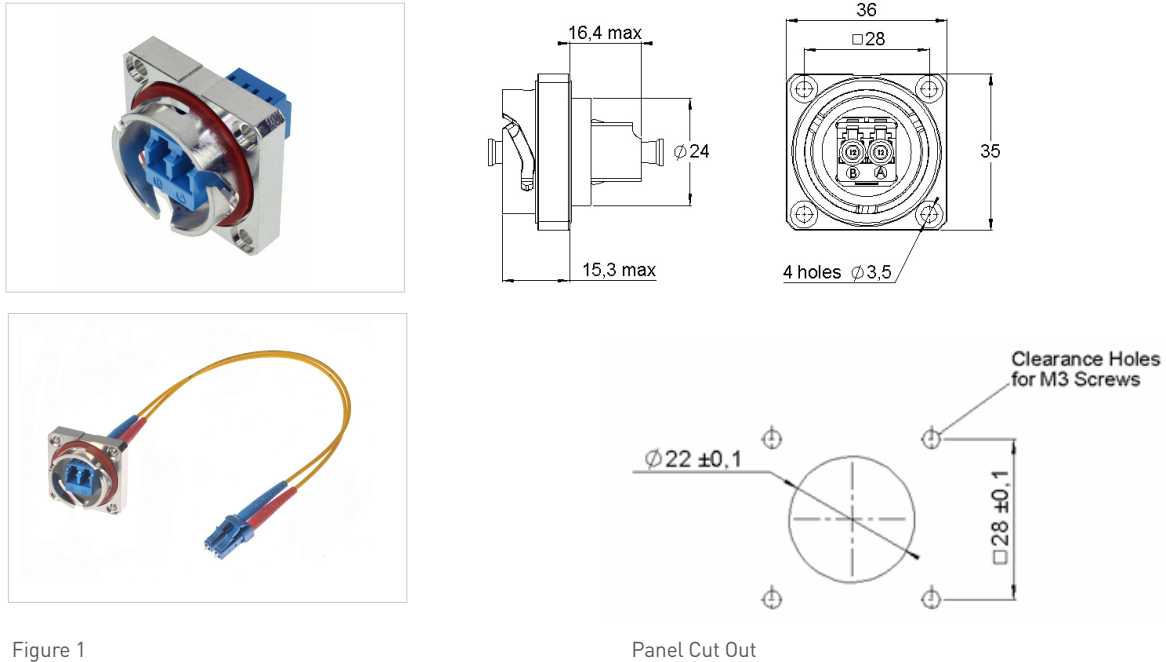

Figure 1

Panel Cut Out

Part Number	Figure	Description	Packaging
R2CT 107 100	1	R2CT® receptacle with LC duplex adapter and LC duplex patchcord, SingleMode – IP67	Per 50 pces
R2CT 107 200	2	R2CT® receptacle with LC duplex adapter, no patchcord SingleMode – IP67	Per 56 pces
R2CT 107 300	3	R2CT® receptacle with LC duplex adapter, no patchcord MultiMode – IP67	Per 56 pces



Figure 2

Figure 3

Product Range

R2CT[®] FIELD ADAPTER PLUG-PLUG

This product allows the connection of two R2CT[®] Plug cable assemblies in the field. It includes a standard LC duplex adapter in MultiMode or SingleMode versions.

Two metal Aluminium protection caps protect each side of the R2CT[®] field adapter and provide a robust solution in outdoor conditions.



Part Number	Description	Packaging
R2CT 157 000	Field Adapter R2CT [®] Plug-Plug, with LC duplex adapter, metal cap MultiMode – IP67	Per 30 pces
R2CT 157 001	Field Adapter R2CT [®] Plug-Plug, with LC duplex adapter, metal cap SingleMode – IP67	Per 30 pces

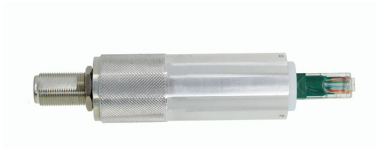
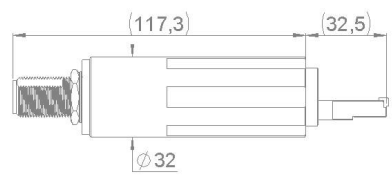

Illustration of use: R2CT[®] Plug Kit
fiber optic cable connected to field adapter

Tools and Accessories

R2CT® ADAPTER N-RJ45

For needs of measurement and control of the RRU and RRH equipment in FTTA applications, a specific version of R2CT® has been developed to adapt the RJ45 connection signal to a coaxial signal with standard N interface.

Picture	Figure	Part Number
		R2CT 135 000

R2CT® EXTENSION KIT

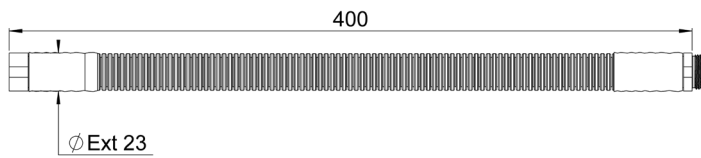

This component allows the use of the standard R2CT® Plug Kit with existing optical patchcords where the fan-out is longer than the one that is recommended to guarantee the solution work properly (95 mm ± 5).

The R2CT® Extension Kit can fit with outdoor cable assemblies including 5 to 7 mm diameter field cables, with a fan-out dimension of up to 450 mm long.

It is mountable in the field and has to be inserted between the R2CT® Plug Kit body and the nut cable gland to guarantee a sealed and robust complete link.

Part Number	Description	Packaging
R2CT 945 000	Extension Kit (plastic) IP67 Temperature range from -40°C to +85°C	Unitary

Cable Assemblies

R2CT® PRE-MOUNTED OPTICAL CABLE ASSEMBLIES

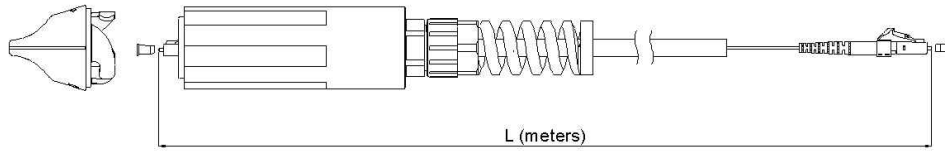

Any configuration for a cable assembly with R2CT® is available on demand:

- Field cables with diameters of 5 to 7 mm on standard
- Standard LC connectors (R2CT® side)
- Any possibility of optical connectors on the opposite side (LC, SC, FC, ST, etc.)
- Simplex or duplex connectors
- MultiMode (50/125 or 62.5/125 on request) or SingleMode (9/125) cable
- Polishing/finishing: PC or APC

OPTICAL CHARACTERISTICS

Insertion Loss (mated with reference plug) (@1310 & 1550 nm)	0.5 dB max
Return Loss (@1310 & 1550 nm)	RL>45 dB

Please refer to Section 9, Cable Assemblies & Optical Systems, for more information.

R2CT® PRE-MOUNTED ON RJ45 CABLE ASSEMBLIES



Pre-assembled R2CT® plug with RJ45 on outdoor patchcord.

R2CT® cable assemblies with RJ45 connectors on 5 to 7 mm diameter cables are available in any length on demand.

Cable Assemblies

PATCHCORDS



LC patchcords



RJ45 patchcord

Radiall can also provide any configuration of LC optical patchcords or RJ45 patchcords for use with the R2CT® Plug Kit. Please refer to Section 9, Cable Assemblies & Optical Systems, for more information.

Notes

SECTION 7



OSIS® Series



Contents

Introduction	
OSIS®: One Step Interconnect Solution	7-3
Applications	7-3
International Standard Documents Compliance	7-3
Features and Benefits	7-3
Characteristics	
Mechanical Characteristics	7-3
Environmental Characteristics	7-3
Product range	
OSIS® Plug Kit	7-4
OSIS® Short Plug Kit	7-5
OSIS® Standard Receptacle	7-6
OSIS® Receptacle with LC Adapter	7-6
OSIS® Pre-Mounted Optical Cable Assemblies	7-8
LC Patchcords	7-9

Introduction

OSIS®: ONE STEP INTERCONNECT SOLUTION



The Quickest Outdoor Interconnect Solution

The OSIS® connector is a fast connection system dedicated to outdoor telecom FTTH applications in a new generation of flexible base stations.

Designed for ensuring a robust, safe and waterproof connection for optical links in field conditions, this very flexible push-pull connector allows a quick connection by the operator in only one click, for use in any type of outdoor application.

APPLICATIONS

Telecom: Fiber To The Antenna

Industrial Connections

Broadcasting



INTERNATIONAL STANDARD DOCUMENTS COMPLIANCE

- IEC 61300 Fiber optic interconnecting devices and passive components
- IEC 60068 Environmental testing
- IEC 60529 Degrees of protection provided by enclosures (IP code)
- RoHS compliant



FEATURES AND BENEFITS

Easy to Install

- Quick lock Push-Pull connection system in one step
- Direct plug into SFP module
- Compensation of the transceiver position tolerances in X, Y and Z axis

Robust and Safe

- LC connectors always protected
- Waterproof and dustproof
- High tensile strength



Flexible and Modular

- Kit assembled in the field without tools over existing optical patchcords
- Compatible with a large range of standard LC connectors and standard SFP transceivers

High Density

- Stackable

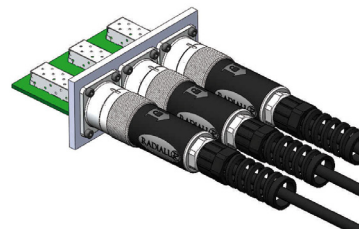

Characteristics

The OSIS® connector has been designed to fulfill the qualification requirements of the IEC 61300 standard (for fiber optic interconnection devices)

MECHANICAL CHARACTERISTICS

Cable retention	200 N
Mating endurance	100 mating cycles minimum

ENVIRONMENTAL CHARACTERISTICS

Ingress protection class	IP65 or IP67
Operating temperature	-40°C/+85°C
Storage temperature	-40°C/+85°C
Salt spray	IEC 61300-2-26 passed
Vibrations	IEC 61300-2-1 passed



Product Range

OSIS® PLUG KIT

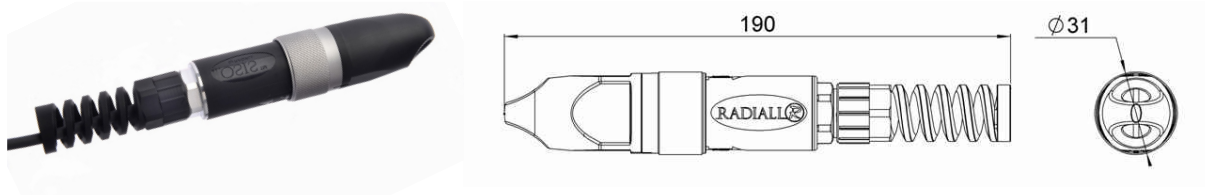

Part Number	Note	Packaging
OSIS 115 000	Plug connector only; no patchcord	Unitary in plastic bag with assembly note

The OSIS® Plug Kit is adapted to all types of optical cable assemblies with simplex or duplex standard LC connectors and 5 to 7 mm diameter MultiMode or SingleMode field cables.

To guarantee proper operation when the OSIS® Plug Kit is assembled over existing optical patchcords, the following fan-out dimensions should be observed:

Fiber stripping tubing recommendations

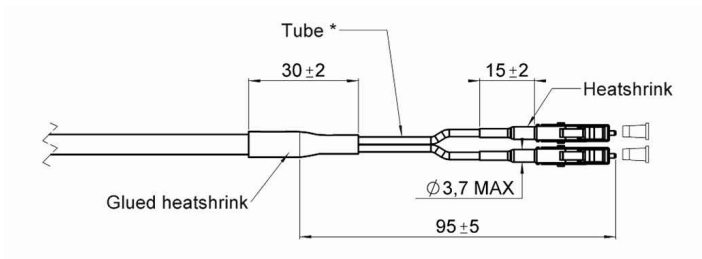

*Tube must be flexible enough to guarantee the bending radius of the fiber.

Radiall recommends the use of OSIS® 990 000 retubing kit.



Radiall recommends using a torque wrench (Radiall PN: R282 303 230) set at 3.5 to 4 Nm to guarantee 200 N tensile strength.

Product Range

OSIS® SHORT PLUG KIT

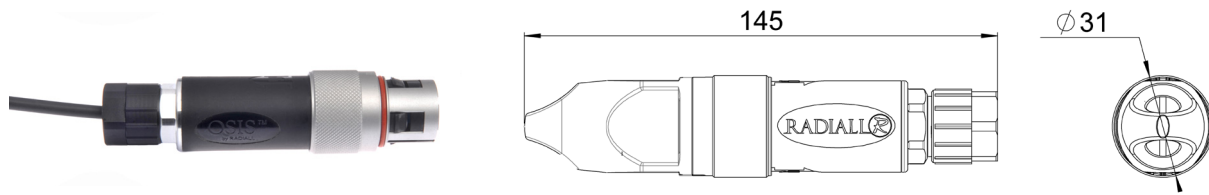

Part Number	Note	Packaging
OSIS 115 001	Plug connector only; no patchcord	Unitary in plastic bag with assembly note

The OSIS® Short Plug Kit addresses customers' needs for reducing the overall dimensions of outdoor optical connections.

The OSIS® Short Plug Kit is adapted to all types of optical cable assemblies with simplex or duplex standard LC connectors and 5 to 7 mm diameter MultiMode or SingleMode field cables.

To guarantee proper operation when the OSIS® Short Plug Kit is assembled over existing optical patchcords, the following fan-out dimensions should be observed:

Fiber stripping and tubing recommendations

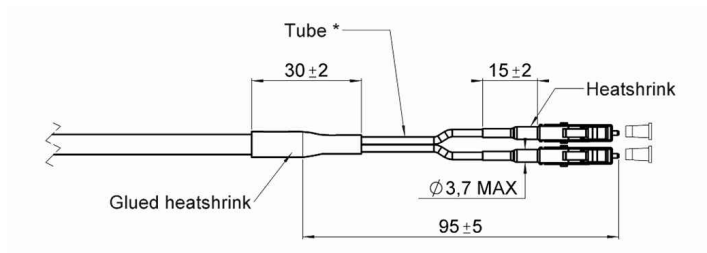

*Tube must be flexible enough to guarantee the bending radius of the fiber.



We recommend to use a torque wrench (Radiall PN: R282 303 230) set at 3.5 to 4 Nm to guarantee 200 N tensile strength.

Product Range

OSIS® STANDARD RECEPTACLES



The standard OSIS® receptacle is IP67 waterproof.
 The receptacle is delivered with the protection cap mounted on the body. It includes a center pin which has to be inserted into the transceiver cage to center the receptacle in the X and Y axis before fixing it on the panel with screws.

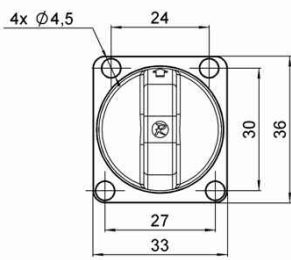

Figure 1

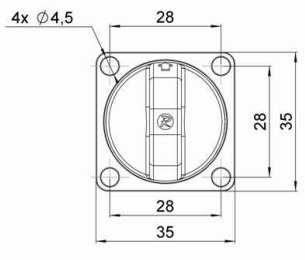

Figure 2

Part Number	Figure	Description
OSIS 107 000	1	Receptacle with trapezoidal fixture holes (foot print 24/27 x 30 mm), centering plastic cap
OSIS 107 001		Receptacle with trapezoidal fixture holes (foot print 24/27 x 30 mm), centering plastic cap with cord
OSIS 107 002	2	Receptacle with square fixture holes (foot print 28 x 28 mm), centering plastic cap
OSIS 107 003		Receptacle with square fixture holes (foot print 28 x 28 mm), centering plastic cap with cord

Packaging: per 60 pieces

Product Range

OSIS® RECEPTACLE WITH LC ADAPTER

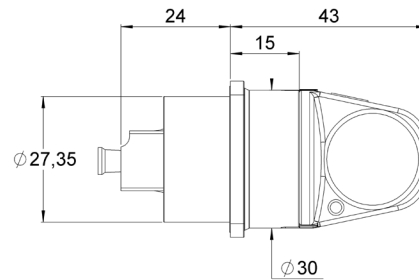
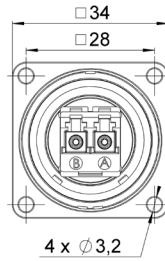

Part Number	Description
OSIS 107 100	OSIS® receptacle with LC duplex adapter, MultiMode, plastic cap – IP67
OSIS 107 101	OSIS® receptacle with LC duplex adapter, SingleMode, plastic cap – IP67
OSIS 107 102	OSIS® receptacle with LC duplex adapter, MultiMode, plastic cap with cord – IP67
OSIS 107 103	OSIS® receptacle with LC duplex adapter, SingleMode, plastic cap with cord – IP67
OSIS 107 104	OSIS® receptacle with LC duplex adapter, SingleMode APC, plastic cap – IP67
OSIS 107 105	OSIS® receptacle with LC duplex adapter, SingleMode APC, plastic cap with cord – IP67

Packaging: per 50 pieces

Product Range

OSIS® PRE-MOUNTED OPTICAL CABLE ASSEMBLIES

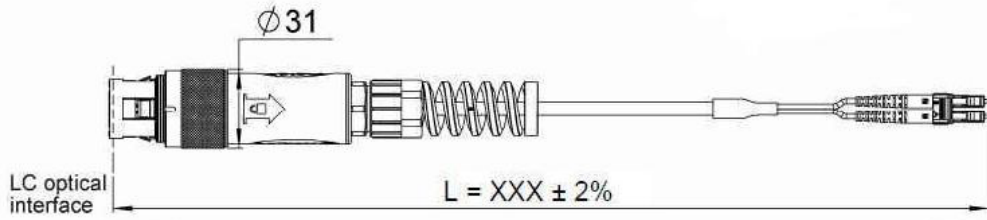

Any configuration of pre-mounted optical cable assembly with OSIS® is available on upon request:

- Standard field cables with diameters of 5 to 7 mm
- Standard LC connectors (OSIS® side)
- A variety of optical connectors are available on the other end (LC, SC, FC, ST, etc.)
- Simplex or duplex connectors
- MultiMode (50/125 μm or 62.5/125 μm on request) or SingleMode (9/125 μm)
- Polishing/finishing: PC or APC

OPTICAL CHARACTERISTICS

According to IEC 61300-3-4 and IEC 61300-3-6

	SingleMode Field Cable	MultiMode Field Cable
Wave Length	1310-1550 nm	850 nm
Insertion Loss (mated with reference plug)	0.5 dB (method 6)	0.5 dB (method 6)
Return Loss	>45 dB (method 7)	-

Product Range

LC PATCHCORDS

Radiall can also provide any configuration of LC optical patchcords for use with the OSIS® Plug Kit



Please refer to Section 9, Cable Assemblies & Optical Systems, for more information.

SECTION 8



OPUS Series



Contents

Introduction	
OPUS: Outdoor Push-Pull Universal Solution	8-2
Applications	8-2
International Standard Documents Compliance	8-2
Features and Benefits	8-2
Characteristics	
Mechanical Characteristics	8-3
Environmental Characteristics	8-3
Concept of Total Modularity	8-3
Product Range	
OPUS Short Plug Kit	8-4
OPUS Receptacle With LC Duplex Adapter	8-5
OPUS Range Extension	8-5
OPUS Pre-mounted Optical Cable Assemblies	8-6
LC Patchcords	8-6

Introduction



OPUS: OUTDOOR PUSH-PULL UNIVERSAL SOLUTION Compact, Dense & Modular

Radiall has initiated a new concept to answer to the most severe requirements of the customers concerning sustainability and impact on the environment:

- reduction of the size of the equipment
- increased level of corrosion resistance: pollutant gases, corrosive atmospheres

Compact, flexible and modular, OPUS is well adapted to this need for deployment of 4G LTE in Telecom Wireless, or any other industrial situation.

APPLICATIONS

- Telecom: Fiber To The Antenna
- Industrial Connections
- Broadcasting



INTERNATIONAL STANDARD DOCUMENTS COMPLIANCE

- IEC 61300 Fiber optic interconnecting devices and passive components
- IEC 60068 Environmental testing
- Telcordia GR-950 Optical Network Unit (ONU) Closures and Systems
- Telcordia GR-3108-CORE Class 4 Network Equipment in the Outside Plant (OSP)
- IEC 60529 Degrees of protection provided by enclosures (IP code)
- RoHS compliant



FEATURES AND BENEFITS

Easy to Install

- Push-Pull connection: same quick lock interface as OSIS®
- More compact
- High density

High Resistance and Sustainability

- All engineered plastic for better corrosion resistance: adapted to Salt Spray combined with pollutant gases (SO₂)
- Waterproof and dustproof: IP67 level
- LC connectors always protected

Flexible and Modular

- Field installable without tools over existing patchcords
- Total modularity of the receptacle and the plug: compatible with any type of signal (optical, ethernet RJ45, or even coaxial)



Push-Pull connection

Characteristics

OPUS solution has been designed to fulfill the qualification requirements of IEC 61300 standard (for fiber optic interconnection devices) and Telcordia GR-950 for American markets.

MECHANICAL CHARACTERISTICS

Cable retention	100 N minimum
Mating endurance	100 mating cycles minimum

ENVIRONMENTAL CHARACTERISTICS

Ingress protection class	IP67
Operating temperature	-40°C/+85°C
Storage temperature	-40°C/+85°C
Salt spray	IEC 61300-2-26 passed, 720H of exposure with addition of SO ₂ gas
Vibrations	IEC 61300-2-1 passed

CONCEPT OF TOTAL MODULARITY

Only one component needs to be changed from one type of signal to another, while the connector shell remains the same.

OPUS generic Short Plug Kit:



OPUS generic receptacle with adapter:

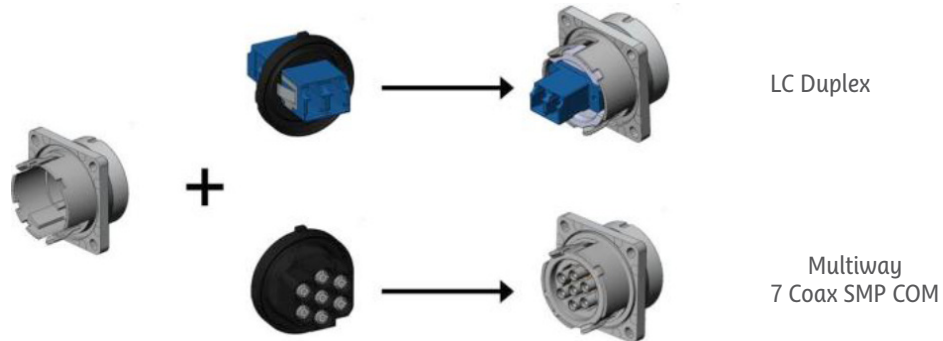

Product Range

OPUS SHORT PLUG KIT



Part Number	Note	Packaging
OPUS 117 200	Plug connector only; no patchcord	Unitary in plastic bag with assembly note

The OPUS Short Plug Kit has been designed to fit with fiber optic cables with a 3 mm diameter and for connection to a receptacle with adapter.

The Kit can be mounted in the field on simplex or duplex cables, with a 3 mm diameter, and ensures an IP67 protection due to the two specific sealing gaskets.

To guarantee proper operation when the OPUS Short Plug Kit is assembled over existing optical patchcords, the following preparation is recommended:

LC Patchcord Termination Recommendations

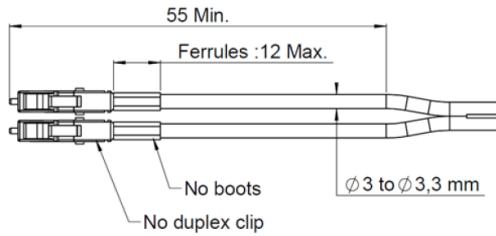

Short OPUS simplex cable connected on receptacle



Short OPUS duplex cable connected on receptacle

Product Range

OPUS RECEPTACLE WITH LC DUPLEX ADAPTER

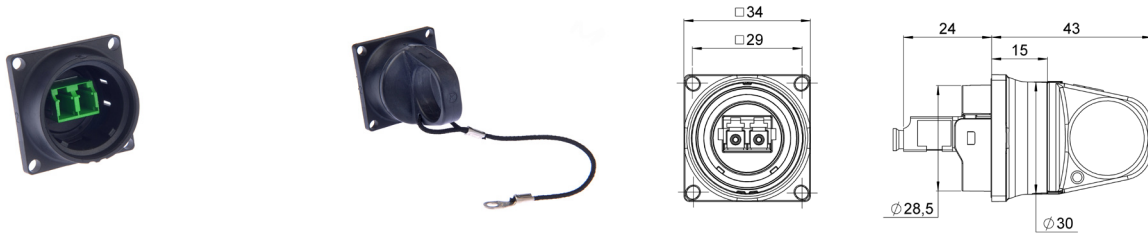

Part Number	Description	Packaging
OPUS 107 200	OPUS receptacle with LC duplex adapter, SingleMode APC*, plastic cap with cord – IP67	60 pieces

*Other versions for MultiMode or SingleMode available upon request. Please contact us.

OPUS RANGE EXTENSION

Development of the following versions:

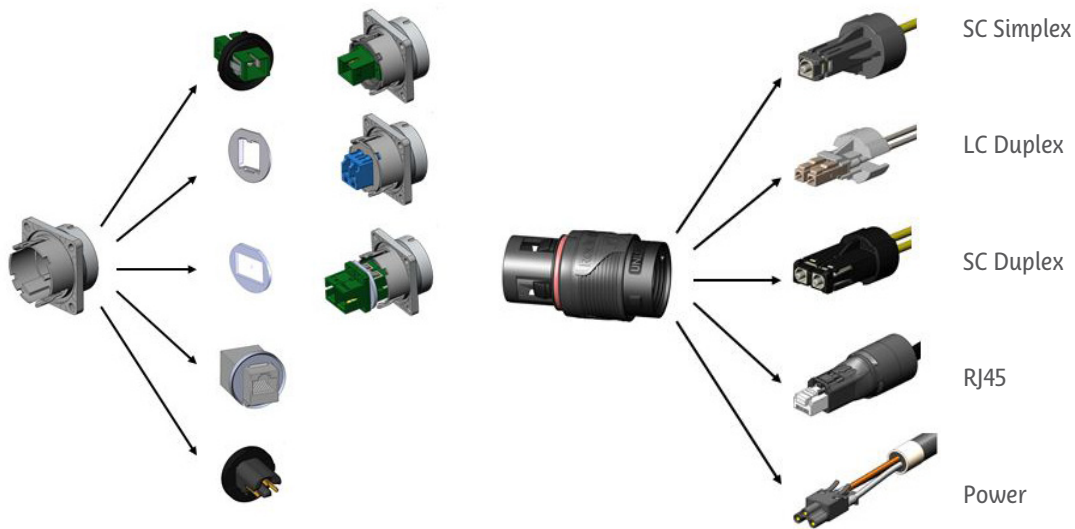

For any additional information, please contact your local Radiall representative.

Product Range

OPUS PRE-MOUNTED OPTICAL CABLE ASSEMBLIES

Any configuration of pre-mounted optical cable assembly with OPUS Short Plug Kit on simplex or duplex cable diameter 3 mm can be available on demand.



A plastic corrugated protective sleeve can fit at the rear extremity of the OPUS Short Plug Kit due to a standard adapted thread, thus ensuring complete IP67 protection over the entire length of the cable.



LC PATCHCORDS

Radiall can also provide any configuration of LC optical patchcords for use with the OPUS Short Plug Kit.

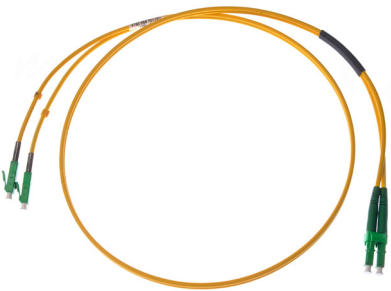

Please refer to Section 9, Cable Assemblies & Optical Systems, for more information.



**Cable Assemblies, Harnesses
and Optical Systems**



Contents

Introduction	
A Complete Offer to Cover All Environments	9-2
Worldwide Radiall Fiber Optic Presence	9-2
End-to-end Harness and Optical System Solutions	9-3
Radiall's Fiber Optic Mission	9-3
Indoor Cable Assemblies	
Presentation	9-4
Components for Indoor Cable Assemblies	9-5
How to Order	9-6
Outdoor Cable Assemblies	
Presentation	9-7
Components for Outdoor Cable Assemblies	9-8
How to Order	9-9
Standard Part Numbers for RXF Cable Assemblies	9-10 to 9-12
Standard Part Numbers for R2CT® Cable Assemblies	9-13
Standard Part Numbers for OSIS® Cable Assemblies	9-14 to 9-15
Harsh Environment Cable Assemblies	
Presentation	9-16
Components for Harsh Environment Cable Assemblies	9-17 to 9-18
How to Order	9-19
Standard Jumpers for Harsh Environments	9-20
MT Based Cable Assemblies	9-21
EB Based Cable Assemblies	9-22
Tactical Cable Assemblies	
Presentation	9-23
Components for Tactical Assemblies	9-24
How to Order	9-25
Accessories	9-26
Product Range Extension	9-26
Harnesses and Optical Systems	
Presentation	9-27
Components for Harnesses and Optical Systems	9-28
Hybrid Electrical/Optical Systems	9-29
Fiber Management and Optical Solutions Layout	9-29
Accessories and Protection	9-29

Introduction

A COMPLETE OFFER TO COVER ALL ENVIRONMENTS

With 40 years of experience in fiber optics, Radiall is an expert in interconnect fiber optic systems. Radiall designs, manufactures and delivers custom cable assemblies with performances specifically adapted to meet customers' requirements and environments.



Indoor Environments

Radiall cable assemblies for indoor applications can be used in stable operational environments for temperature ranges of -20° to +70°C for Telecom applications. They provide high bandwidth, durability and are cost efficient.



Outdoor Environments

Temperature ranges for outdoor applications are typically from -40°C to +85°C. Radiall cable assemblies and harnesses for outdoor applications (ex: FTTA) feature durability and ease of integration while maintaining high optical performances.



Harsh Environments

Optical systems for harsh environments must withstand extreme temperature ranges, typically from -55°C to +125°C, and high levels of shock and vibration. They are especially dedicated to military and aerospace applications. Radiall's experience, combined with an extensive range of products developed specifically for harsh environments, allows Radiall to provide high quality cable assemblies and harnesses adapted to these environments.



Tactical Environments

Tactical cable assemblies are field deployable and operate in unstable and severe environmental conditions. Radiall provides ruggedized solutions, using tactical Expanded Beam connectors, to enable quick, reliable and easy integration for advanced communication systems in the field.



WORLDWIDE RADIALL FIBER OPTIC PRESENCE



Radiall has a global manufacturing presence. An International sales network and qualified distributors cover every region around the world. The result is quick and detailed technical support for all requests.



Characteristics and Performance

END-TO-END HARNESS AND OPTICAL SYSTEM SOLUTIONS

With an extensive product range, Radiall supports customers from the design to the production and the full industrial release of fiber optic harnesses and optical systems.

Design and Engineering

- Experienced and specialized R&D teams with more than 100 patents on optical interconnect solutions
- Dedicated design centers for design, development and prototyping
- High reactivity is made possible by close collaboration between sales, R&D and production teams

Radiall Manufacturing Capabilities

- Worldwide presence to ensure the proximity needed to provide the best quality, service and delivery performance
- Flexibility to handle high, low and mixed volumes with the same high level of quality

High-quality and Large Variety of Components

- Optical fibers and cables
- Connectors and contacts
- Cable protection and fiber management accessories

Optimized Processes

- Design, development and modeling of the optical solution
- Customer support services

Test and Quality Insurance

- Qualified test laboratories to perform product qualifications
- Radiall facilities feature state-of-the-art equipment and are all certified ISO9001-V2008 and AS9100, fully supporting the customer's quality system requirements
- Radiall optical systems are designed, manufactured and tested in accordance with all of the relevant industry standards and customers' specifications
- All measurements and quality reports can be delivered upon request



RADIALL'S FIBER OPTIC MISSION



End-to-End Fiber Optic solutions for demanding applications	40 years experience in Fiber Optic	Extensive test, qualification and lean manufacturing capabilities
Constant pursue of Fiber Optic innovation		High added-value engineering
High end optical connectors and optimized accessories	Optical systems, harnesses and integrated solutions design and production	Radiall's expertise at your service through high quality product, training and support

Our Most Important Connection is with You.™

Indoor Cable Assemblies

PRESENTATION

Radiall provides optimized cable assembly solutions for indoor applications, taking into account cost, availability and performance.

Cable assemblies for indoor applications are ideal for telecom, industrial, instrumentation and medical markets. These cable assemblies are used in controlled and relatively stable environments such as wireless, FTTX, data centers, switch centers and CATV applications.

Telecom Industrial Medical Instrumentation



Typical Indoor Requirements

- Operational temperature from -20°C to +70°C
- High bandwidth
- High durability (mating/unmating)
- Cost optimized

Radiall Key Factors

- Design to cost
- Mass-production capability
- High reactivity: quality in short lead time

Radiall Guarantee of Quality

- Optical measurements (IL, RL) are performed according to the IEC 61300 standards before shipment
- Visual inspection of the end face geometry to ensure the cable assembly meets the defined criteria
- Test measurement sheets with detailed reporting of the performance can be requested

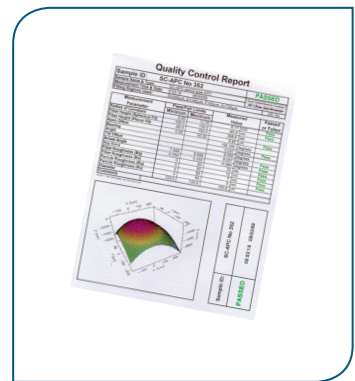

Indoor Cable Assemblies

COMPONENTS FOR INDOOR CABLE ASSEMBLIES

Typical Optical Fibers:

Radiall can accommodate various types of fiber, including the most popular fibers used for data transmission:

- SingleMode 9/125 μm
- MultiMode 50/125 μm OM2, OM3 and OM4
- MultiMode 62.5/125 μm

Typical Cables for Indoor Environments:

- Indoor cables withstand temperature ranges from -20°C to $+70^{\circ}\text{C}$
- Compliant to GR-409 Telcordia standard specifications
- Duplex, simplex and multi-fiber configurations are available
- Cable diameter from 0.9 mm to 3 mm
- Loose and tight structure cables

Radiall can work with most cables required by the customer's specific needs.

The structure of the cable is a key parameter in the choice of the connector or the contact and is usually determined by the system design. A feasibility study may be conducted to validate the selected connector/cable combination.

Polishing Processes Available:

Depending on specific requirements and application, the following polishing process may be used:

- PC: Physical Contact for MultiMode or SingleMode
- UPC: Ultra Physical Contact for MultiMode or SingleMode
- APC (8°): Angled Physical Contact for SingleMode only. For higher performance of Return Loss due to the angled end face.

Refer to Section 12, Technical Information, for more information on cable structure, polishing, testing and inspection.

TYPICAL CONNECTORS FOR INDOOR ENVIRONMENTS

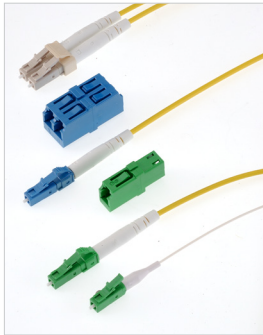

LC connectors

IEC 61754-20 standard
Radiall is an official licensee to manufacture and supply LC connectors. Available in simplex and duplex configurations.

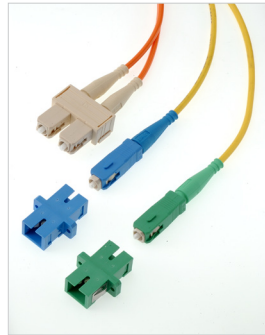

SC connectors

IEC 61754-4 standard
Available in simplex and duplex configurations.



ST connectors

IEC 61754-2 standard
Also available in sealed configurations.



FC connectors

IEC 61754-13 standard

Please refer to Section 4, LC, SC and ST Series, for more detailed information.

Radiall can produce many other connectors, contacts or fiber types. For any additional information, please contact your local Radiall representative.

Indoor Cable Assemblies

HOW TO ORDER

Radiall designs, manufactures and delivers high quality cable assemblies for indoor applications based on existing components listed above. The cable assemblies are tested for insertion loss and face visual inspection following the IEC 61300 standards.

Build-to-print:

With the build-to-print solution, Radiall complies with customer requirements, offering flexible design and manufacturing processes to build assemblies to the exact specifications. Please provide a print or requirement description to your local representative. A Technical Data Sheet will then be provided for validation.

Standard Jumper:

Using the part number builder, define the cable assembly part number by selecting the fiber optic contact and/or connector type for each end, cable type and length. Standard jumpers are considered catalog items with short lead times due to direct availability of components and established manufacturing processes.

PART NUMBER BUILDER:

LCMM 10 FCMM L100

End 1:

LCMM	LC	MultiMode	
LCSM	LC	SingleMode	UPC (RL>50dB)
LCSM8	LC	SingleMode	APC 8° (RL>65dB)
SCMM	SC	MultiMode	
SCSM	SC	SingleMode	UPC (RL>50dB)
SCSM8	SC	SingleMode	APC 8° (RL>65dB)
FCMM	FC	MultiMode	
FCSM	FC	SingleMode	UPC (RL>50dB)
FCSM8	FC	SingleMode	APC 8° (RL>65dB)
STMM	ST	MultiMode	
STSM	ST	SingleMode	UPC (RL>50dB)

Cable:

10	900 µm	MM 50/125 µm	tight	Simplex	commercial grade
11	900 µm	MM 50/125 µm	tight	Simplex	commercial grade
13	900 µm	MM 50/125 µm	loose	Simplex	commercial grade
60	900 µm	SM 9/125 µm	tight	Simplex	commercial grade
27	1.8-2 mm	MM 50/125 µm	loose	Simplex	commercial grade
39	1.8-2 mm	MM 50/125 µm	loose	Scindex	commercial grade
23	1.8-2 mm	MM 62.5/125 µm	loose	Simplex	commercial grade
40	1.8-2 mm	MM 62.5/125 µm	loose	Scindex	commercial grade
73	1.8-2 mm	SM 9/125 µm	loose	Simplex	commercial grade
77	1.8-2 mm	SM 9/125 µm	loose	Scindex	commercial grade

End 2:

See end 1

X no termination (pigtail)

Length of the cable in centimeters

Standard Length Tolerance in Centimeters	
from 12 to 100 cm	0/+2.4 cm
from 100 to 1500 cm	0/+3.4 cm
from 1500 to 3000 cm	0/+4.4 cm
from 3000 to 5000 cm	0/+17.4 cm

To validate your part number please consult your Radiall representative.

Technical datasheets are available upon request.

Outdoor Cable Assemblies

PRESENTATION

Radiall offers a wide range of cable assemblies for Telecom and Industrial applications in outdoor environments, manufacturing and delivering optimized optical link solutions in the field incorporating durability, performance, ease of integration and cost effective solutions.

Outdoor cable assemblies can sustain unstable environmental conditions and broad operating temperature ranges as in FTTX and telecom installation markets, energy distribution networks, smart grids, broadcasting, security and industrial applications.

Telecom



Industrial



Typical Outdoor Requirements

- High optical performance
- Robust connection to withstand severe external conditions such as bad weather
- Operational temperature from -40°C to +85°C.
- Less sensitivity to corrosion and pollution
- High tensile strength
- High resistance to crushes, humidity and UV radiation

Radiall Key Factors

- Proven and ruggedized high quality components
- Designed and manufactured in Radiall facilities
- Wide variety of manufacturable assemblies available
- Custom solutions for specific applications
- Mass-production capacity

Radiall Guarantee of Quality

- Optical measurements (IL, RL) are performed according to the IEC 61300 standards before shipment
- Visual inspection of the end face geometry to ensure the cable assembly meets the defined criteria
- Test measurement sheets with detailed reporting of the performance can be requested
- Radiall can conduct other tests according to specific requirements on demand

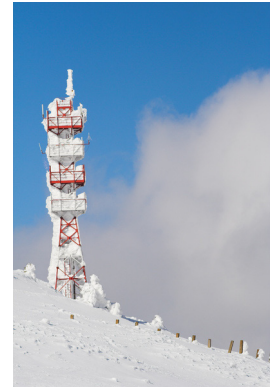

Outdoor Cable Assemblies

COMPONENTS FOR OUTDOOR CABLE ASSEMBLIES

Typical Optical Fibers:

Radiall can accommodate various types of fiber, including the most popular fibers used for data transmission:

- SingleMode 9/125 μm
- MultiMode 50/125 μm OM2, OM3 and OM4
- MultiMode 62.5/125 μm

Typical Cables for Outdoor Environments:

- Outdoor grade cable: temperature range -40°C to $+85^{\circ}\text{C}$
- Simplex, duplex and multi-fiber cables
- Tight structure cables and breakout cables

Note: Other types of cable can be used to answer to specific customer technical requirements: specific temperature range, larger diameters, armored and anti-rodent configurations, ruggedized telecom cables, etc.

For any additional information, please contact your local Radiall representative.

Polishing Processes Available:

Depending on requirements and applications the following processes may be used:

- PC: Physical Contact for MultiMode or SingleMode
- UPC: Ultra Physical Contact for SingleMode or MultiMode
- APC (8°): Angled Physical Contact for SingleMode only. For higher performance of return loss due to the angled end face.

TYPICAL CONNECTORS FOR OUTDOOR ENVIRONMENTS



RXF (2 to 6 channels)

Screwing locking device with IP68 sealing connection.

Refer to RFX connectors in Section 5 for more information.



R2CT®

Flexible waterproof connection.

Plug equipped with LC (simplex or duplex) or SC simplex.

Refer to R2CT® connectors in Section 6 for more information.



OSIS®

Quick lock push-pull and stackable connection.

Plug equipped with LC (simplex or duplex)

Refer to OSIS® connectors in Section 7 for more information.

Radiall can produce standard interface connectors such as LC, SC, FC and ST for outdoor cable assemblies.

For any additional information, please contact your local Radiall representative.

Outdoor Cable Assemblies

HOW TO ORDER

Radiall can provide custom configurations of optical cable assemblies for outdoor use based on existing components listed above. Assemblies can be customized to fit with specific application requirements such as labeling, length, etc.

All products will be manufactured in AS9100 certified assembly lines. The outdoor assemblies are visually inspected and tested per the criteria from IEC 61300 and/or the specified industry standards.

Customer Specification:

Based on cable assemblies specifications, Radiall will study and propose the best solution, providing a compliance matrix for validation.

Configure a Cable Assembly:

1. Series: RXF, R2CT®, OSIS®, LC, etc.
2. Connector end 1 + protective cap
3. Connector end 2 + protective cap
4. Fiber and cable type
5. Length (in meters or millimeters)

Radiall will provide a Technical DataSheet (TDS) for validation.

Select a Cable Assembly Among Standard Part Numbers:

Radiall designs, manufactures and supplies standard outdoor cable assemblies. A standard configuration combines standard fiber optic connectors and cables with standard length and tolerances. Standard outdoor cable assemblies are catalog items with short lead times due to the direct availability of the components.



Outdoor Cable Assemblies

STANDARD PART NUMBERS FOR RXF CABLE ASSEMBLIES

OPTICAL CHARACTERISTICS

Wave-length	1310-1550 nm
Insertion Loss	max 0.5 dB
Return Loss	>50 dB

Insertion Loss against a reference patchcord: IEC 61300-3-4 Method B
Return Loss: IEC 61300-3-6

Note: the optical performances also depend on the fiber or cable construction.
All RXF connectors in cable assemblies are provided with a dust cap (red vinyl).
All measurements and quality reports can be delivered upon request.



ENVIRONMENTAL CHARACTERISTICS

Operating Temperature Range	-40°C/+85°C
-----------------------------	-------------

R2F Socket Square Flange to LC Duplex – Indoor Simplex Cable Ø2 mm

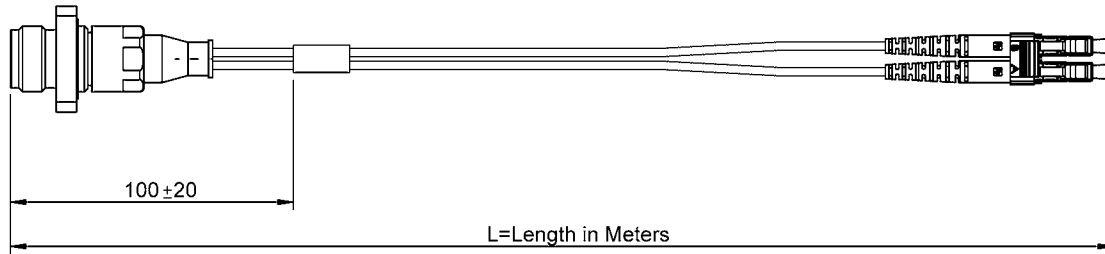

Fiber Type	Part Number	Length
SM 9/125 μm G652	F760 855 220	L=1 m
MM 50/125 μm OM2	F760 858 220	L=1 m

Note: Other lengths are available upon request.

R4F Socket Hexagonal to 2 x LC Duplex – Indoor Simplex Cable Ø2 mm

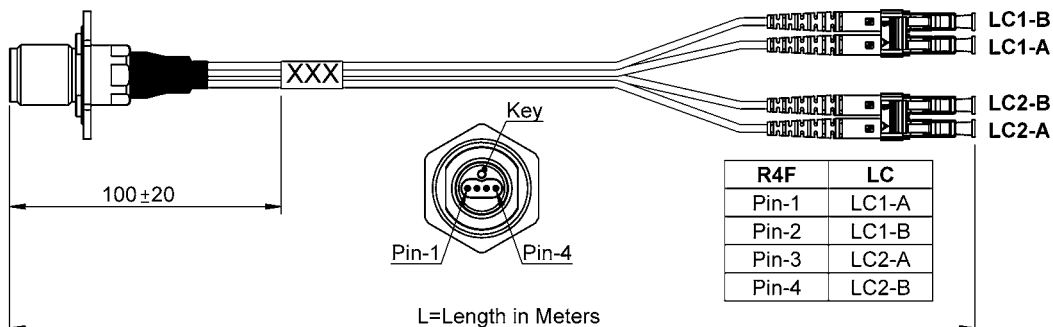

Fiber Type	Part Number	Length
SM 9/125 μm G652	F760 855 240	L=1 m
MM 50/125 μm OM2	F760 858 240	L=1 m

Note: Other lengths are available upon request.

Outdoor Cable Assemblies

R2F Plug to LC Duplex – Outdoor Field Cable Ø5 mm

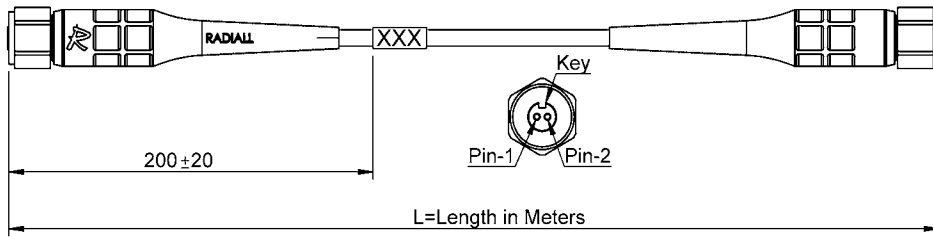

Fiber Type	Part Number (*)
SM 9/125 μm G652	F760 855 620-XX
MM 50/125 μm OM2	F760 858 620-XX

(*): replace “XX” by the length in meters

Standard length: 5 m and 50 m

Ex: F760 855 620-05 for 5 m



R2F Plug to R2F Plug – Outdoor Field Cable Ø5 mm

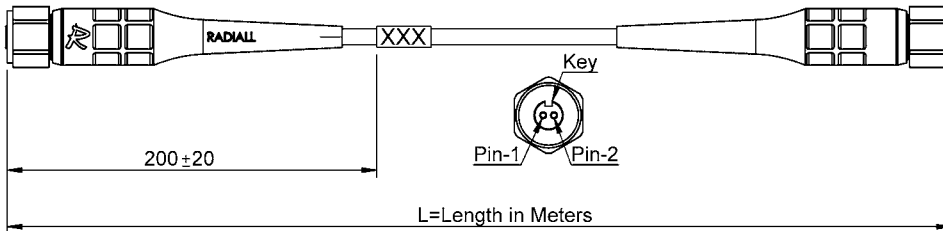

Fiber Type	Part Number (*)
SM 9/125 μm G652	F760 885 620-XX
MM 50/125 μm OM2	F760 888 620-XX

(*): replace “XX” by the length in meters

Standard length: 5 m and 50 m

Ex: F760 885 620-05 for 5 m

Outdoor Cable Assemblies

R4F Plug to 2 x LC Duplex – Outdoor Field Cable Ø5 mm

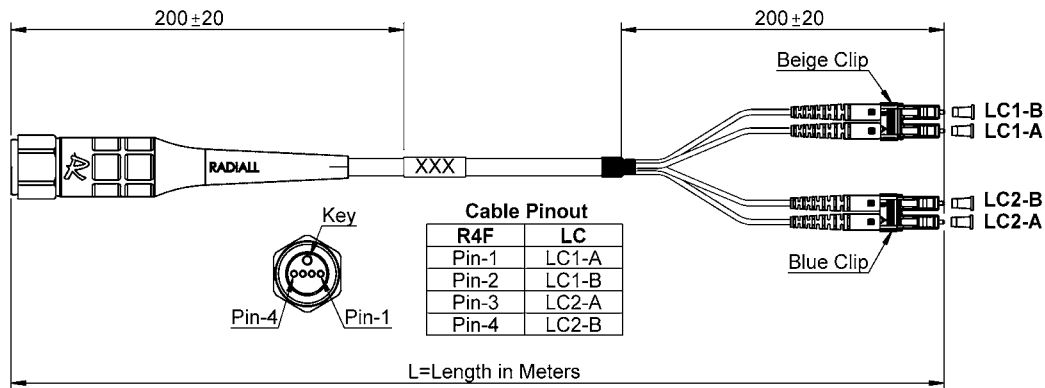

Fiber Type	Part Number (*)
SM 9/125 µm G652	F760 855 640-XX
MM 50/125 µm OM2	F760 858 640-XX

(*): replace "XX" by the length in meters

Standard length: 5 m and 50 m

Ex: F760 855 640-05 for 5 m

R4F Plug to R4F Plug – Outdoor Field Cable Ø5 mm

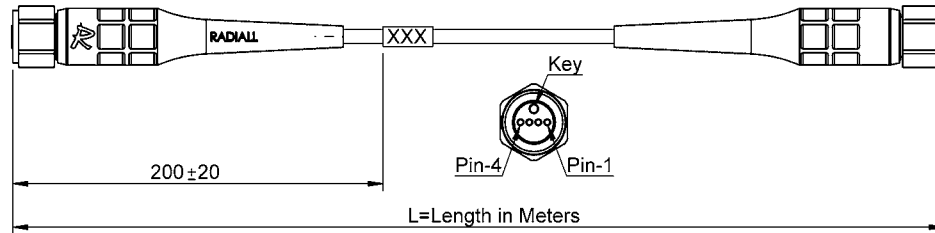

Fiber Type	Part Number (*)
SM 9/125 µm G652	F760 885 640-XX
MM 50/125 µm OM2	F760 888 640-XX

(*): replace "XX" by the length in meters

Standard length: 5 m and 50 m

Ex: F760 885 640-05 for 5 m



Outdoor Cable Assemblies

STANDARD PART NUMBERS FOR R2CT® CABLE ASSEMBLIES

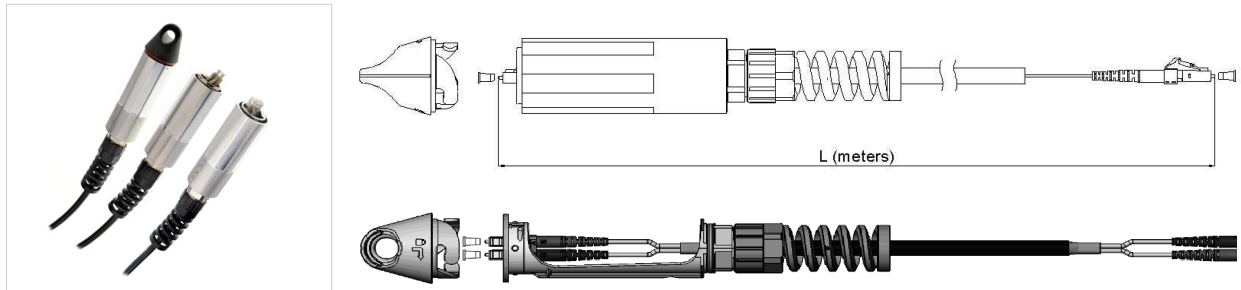

OPTICAL CHARACTERISTICS

Wave Length	1310-1550 nm
Insertion Loss	max 0.5 dB
Return Loss	>45 dB

Insertion loss against a reference patchcord: IEC 61300-3-4 Method B

Return loss: IEC 61300-3-6

Note: the optical performances also depend on the fiber or cable construction.

ENVIRONMENTAL CHARACTERISTICS

Operating Temperature Range	-40°C/+85°C
-----------------------------	-------------

R2CT® Plug to LC Duplex – Outdoor Field Cable Ø7 mm

Fiber Type	Part Number	Length
SM 9/125 µm G657a	R2CTC 855 700-01	L=1 m
SM 9/125 µm G657a	R2CTC 855 700-02	L=2 m
SM 9/125 µm G657a	R2CTC 855 700-03	L=3 m
MM 50/125 µm OM2	R2CTC 858 700-01	L=1 m
MM 50/125 µm OM2	R2CTC 858 700-02	L=2 m
MM 50/125 µm OM2	R2CTC 858 700-03	L=3 m

Note: Other lengths are available upon request.

Outdoor Cable Assemblies

STANDARD PART NUMBERS FOR OSIS® CABLE ASSEMBLIES

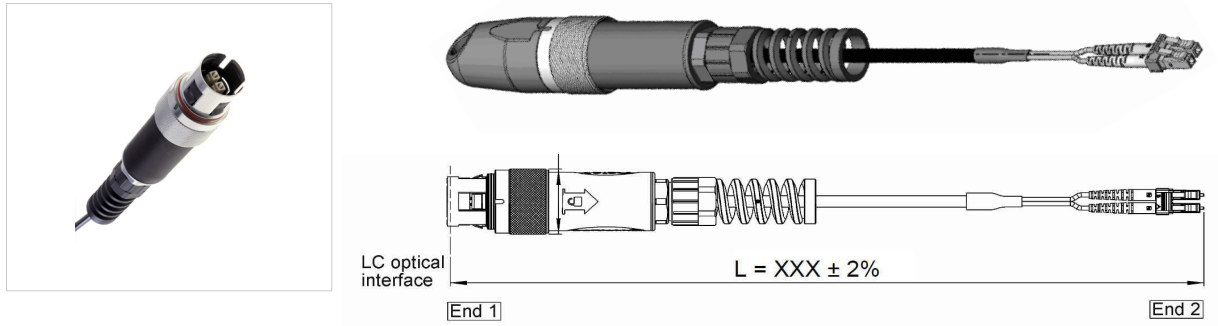

OPTICAL CHARACTERISTICS

Wave-length	1310-1550 nm
Insertion Loss	max 0.5 dB
Return Loss	>45 dB

Insertion Loss against a reference patchcord: IEC 61300-3-4 Method B

Return Loss: IEC 61300-3-6

Note: the optical performances also depend on the fiber or cable construction.

ENVIRONMENTAL CHARACTERISTICS

Operating Temperature Range	-40°C/+85°C
-----------------------------	-------------

OSIS® Plug to LC Duplex – Outdoor Field Cable Ø5 mm

Fiber Type	Part Number	Length
SM 9/125 µm G657a	OSISC 855 500-01	L=1 m
SM 9/125 µm G657a	OSISC 855 500-02	L=2 m
SM 9/125 µm G657a	OSISC 855 500-03	L=3 m
MM 50/125 µm OM2	OSISC 858 500-01	L=1 m
MM 50/125 µm OM2	OSISC 858 500-02	L=2 m
MM 50/125 µm OM2	OSISC 858 500-03	L=3 m

Note: Other lengths are available upon request.

Outdoor Cable Assemblies

STANDARD PART NUMBERS FOR LC CABLE ASSEMBLIES

LC Duplex to LC Duplex – Outdoor Field Cable Ø7 mm

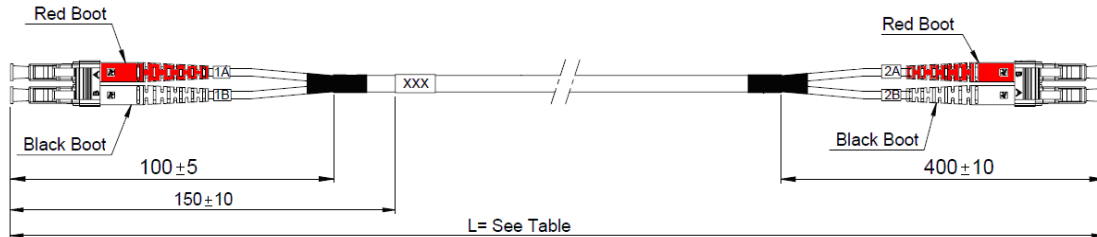

Length L (meters)

Fiber Type	Part Number (*)
SM 9/125 µm G652	F760 555 670-XXX

(*): replace “XXX” by the length in meters

Standard lengths (in meters) for SM: 1, 2, 5, 10, 15, 20, 30, 40, 50, 60, 70, 80, 90, 100, 125, 150 m

Ex: F760 555 670-005 for L=5 m

Note: Other lengths and MultiMode are available upon request.

12 LC to LC – Outdoor Field Cable Ø8 mm

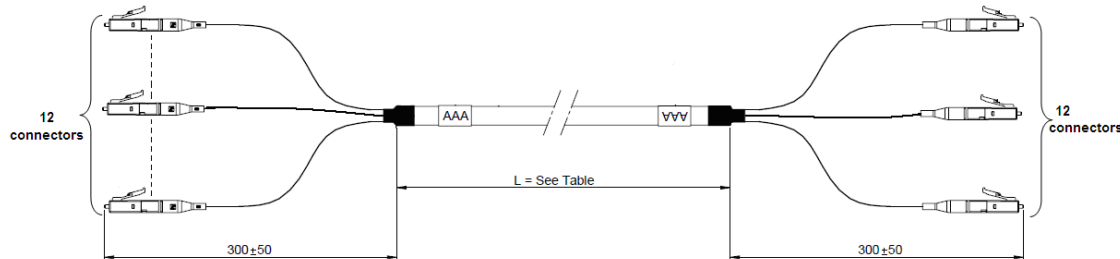

Fiber Type	Part Number (*)
SM 9/125 µm G652	F760 555 612-XXX

(*): replace “XXX” by the length in meters

Standard lengths (in meters) for SM: 5, 10, 20, 30, 40, 50, 70, 100, 200 m

Ex: F760 555 612-005 for L=5 m

Note: Other lengths and MultiMode are available upon request.



Harsh Environment Cable Assemblies

PRESENTATION

Recognized worldwide for its expertise, Radiall is a leading manufacturer of fiber optic solutions in harsh environments, chosen by major aerospace and military companies for the constant quality of products, extensive product range and reliable service. We supply our customers with high quality and high performance patchcords and harness assemblies that fulfill the demanding requirements of the aerospace and defense markets.



Harsh environment cable assemblies can withstand unstable and extreme environmental conditions as in radars, sensors, pressurized areas, avionics data transmission or In-Flight Entertainment applications and more.



Aerospace



Defense



Industrial



Typical Requirements for Harsh Environment Applications

- High optical performance
- Robust connection to withstand shocks and vibrations
- Operational temperature from -55°C to +125°C and beyond
- Lightweight and small form factor
- High density and high channel count
- Less sensitivity to corrosion, pressure and humidity

Radiall Key Factors

- Chosen manufacturer for major aerospace companies for over 10 years
- Proven, rugged and high quality components
- Expertise and support to deliver the optimal solution according to the application
- Ability to design according to customer print or from Radiall expertise
- Innovation in designing and manufacturing processes to deliver cost optimized and reliable solutions

Radiall Guarantee of Quality

- Assemblies are visually inspected and tested per the criteria from the relevant industry standards (ARINC, EN, SAE, IEC)
- All products for aerospace applications are manufactured in AS9100 certified assembly lines
- Test measurement sheets with detailed reporting of the performance can be delivered
- Radiall can conduct and supply other test data and qualification test reports to meet specific requirements

Harsh Environment Cable Assemblies

COMPONENTS FOR HARSH ENVIRONMENT CABLE ASSEMBLIES

Typical Optical Fibers:

Radiall can accommodate various types of fiber, including the most popular fibers used for data transmission:

- SingleMode 9/125 μm
- MultiMode 50/125 μm OM2, OM3 and OM4
- MultiMode 62.5/125 μm or larger core fibers

Typical Cables for Indoor Environments:

- Aerospace grade cable, loose structure, ARINC 802, temperature range (-55°C/+125°C and beyond)
- Aerospace grade cable, tight structure, ARINC 802, temperature range (-55°C/+125°C and beyond)
- Commercial grade cable "not for flight" for ground test applications
- Military cable
- Ruggedized, armored and anti-rodent telecom cable for outdoor applications
- Simplex, duplex and multi-fiber cables

Note: Standard temperatures are listed above but higher temperatures can be achieved with specific cables.

Radiall can work with most cable types required by the customer. The structure of the cable is a key parameter in the choice of the connector and/or the contact, it is usually determined by system design. A feasibility study may be conducted to validate the selected connector/cable combination.



Polishing Processes Available:

Depending on specific requirements application, the following process may be used:

- PC: Physical Contact for MultiMode or SingleMode
- UPC: Ultra Physical Contact for SingleMode or MultiMode.
- APC (8°): Angled Physical Contact for SingleMode only. For higher performance of Return Loss due to the angled end face.

Harsh Environment Cable Assemblies

TYPICAL FIBER OPTIC CONTACTS FOR HARSH ENVIRONMENTS

LuxCis® ARINC 801 contact



The LuxCis® ARINC 801 contact provides high optical performances maintained in harsh environments. It is a high density solution and is easy to use. The LuxCis® design was selected as the ARINC 801 FO interconnect solution for aerospace applications per the AEEC. It is Airbus qualified ABS1906-01 and Boeing qualified BACT64A.

MIL-PRF-29504 type termini



Designed to fit into standard electrical cavities within circular and rectangular multipin connectors. MIL-PRF-29504 type termini are described in several military standards. Radiall has developed its own design, adding improved features to this standard part.

ABS1379 contact



Radiall ABS1379 optical contact is Airbus qualified ABS1379-003 per EN 4531-101. Based on the standardized product design, Radiall has improved the sealing function and the fiber accompanying process.



Key Features & Benefits:

- Standardized contact: ARINC 801, EN4639-101 compliant, AS5590 AS5591, BACT64A, ABS1906-01
- High density with 1.25 mm ferrule
- MultiMode, SingleMode and SM APC polishing available
- Hermaphroditic contact
- Same contact fits a wide range of multipin connectors

Refer to Section 1, LuxCis® ARINC 801 Contacts, for more information.

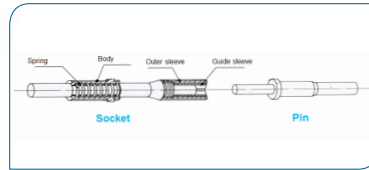

Key Features & Benefits:

- Compatible with size 16 or size 12 standard electrical cavities
- Non hermaphroditic termini
- For MultiMode fibers only
- Designed with a protected spring loaded mechanism and unique releasing boot holder

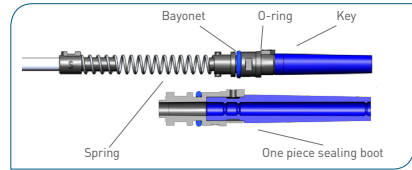

Key Features & Benefits:

- Robust construction with spring loaded butt-joint
- Standard 2.5 mm diameter ferrule
- To be used with MultiMode fibers only
- Key and bayonet systems to prevent rotation
- Integrated sealing

TYPICAL CONNECTORS FOR HARSH ENVIRONMENTS

Ruggedized LC connectors



IEC 61754-20 standard

Available in simplex and duplex configurations

Radiall is an official licensee to manufacture and supply LC connectors

Ruggedized SC connectors



IEC 61754-4 standard

Available in simplex and duplex configurations

Ruggedized FC connectors



IEC 61754-13 standard

Ruggedized ST connectors



IEC 61754-2 standard

Radiall can produce many other connectors or contacts. For any additional information, please contact your local Radiall representative.

Harsh Environment Cable Assemblies

HOW TO ORDER

Radiall designs, manufactures and delivers either build-to-print and custom cable assemblies or standard jumpers to withstand harsh environment conditions. The cable assemblies can be customized to accommodate specific requests such as labeling, lengths and packaging. All products will be manufactured in AS9100 certified assembly lines and assembly processes allow for low, high and mixed volume requirements.

Build-to-print:

With the build-to-print solution, Radiall complies with customer requirements, offering flexible design and manufacturing processes to build assemblies to the exact specifications. A Technical Data Sheet or compliance matrix will then be provided for validation.

The best adapted fiber optic interconnect solution will be used, including MT ferrules, Expanded Beam inserts and contacts.

Standard Jumpers:

Using the part number builder (see next page), define the specific cable assembly by selecting a fiber optic contact/connector for each end, cable type and length from the available choices. Standard jumpers are considered catalog items with short lead times due to direct availability of components and established manufacturing processes.

Harsh Environment Cable Assemblies

STANDARD JUMPERS FOR HARSH ENVIRONMENTS

Radiall designs, manufactures and delivers high quality cable assemblies. They are manufactured in AS9100 certified assembly lines. Each cable is visually inspected and tested before shipment.

PART NUMBER BUILDER

LUXCISMM 52 LCMM L100

End 1: ←

LUXCISMM	LuxCis®	MultiMode	
LUXCISSM	LuxCis®	SingleMode	UPC (RL>50dB)
LUXCISSM8	LuxCis®	SingleMode	APC 8° (RL>65dB)
LCMM	LC	MultiMode	
LCSM	LC	SingleMode	UPC (RL>50dB)
LCSM8	LC	SingleMode	APC 8° (RL>65dB)
SCMM	SC	MultiMode	
SCSM	SC	SingleMode	UPC (RL>50dB)
SCSM8	SC	SingleMode	APC 8° (RL>65dB)
FCMM	FC	MultiMode	
FCSM	FC	SingleMode	UPC (RL>50dB)
FCSM8	FC	SingleMode	APC 8° (RL>65dB)
STMM	ST	MultiMode	
STSM	ST	SingleMode	UPC (RL>50dB)
ABS1379MM	ABS1379	MultiMode	

Cable: ←

14	900 µm	MM 62.5/125 µm	loose	Simplex	aerospace grade
15	900 µm	MM 62.5/125 µm	tight	Simplex	aerospace grade
16	900 µm	MM 50/125 µm	loose	Simplex	aerospace grade
13	900 µm	MM 62.5/125 µm	loose	Simplex	commercial grade
11	900 µm	MM 62.5/125 µm	tight	Simplex	commercial grade
10	900 µm	MM 50/125 µm	tight	Simplex	commercial grade
60	900 µm	SM 9/125 µm	tight	Simplex	commercial grade
52	1.8-2 mm	MM 62.5/125 µm	loose	Simplex	aerospace grade
52D	1.8-2 mm	MM 62.5/125 µm	loose	Duplex	aerospace grade
53	1.8-2 mm	MM 62.5/125 µm	tight	Simplex	aerospace grade
55	1.8-2 mm	MM 50/125 µm	loose	Simplex	aerospace grade
78	1.8-2mm	MM 50/125 µm	tight	Simplex	aerospace grade
92	1.8-2 mm	SM 9/125 µm	loose	Simplex	aerospace grade
23	1.8-2 mm	MM 62.5/125 µm	loose	Simplex	commercial grade
40	1.8-2 mm	MM 62.5/125 µm	loose	Scindex	commercial grade
27	1.8-2 mm	MM 50/125 µm	loose	Simplex	commercial grade
39	1.8-2 mm	MM 50/125 µm	loose	Scindex	commercial grade
73	1.8-2 mm	SM 9/125 µm	loose	Simplex	commercial grade
77	1.8-2 mm	SM 9/125 µm	loose	Scindex	commercial grade

End2: ←

See end 1

X no termination

Length of the cable in centimeters ←

Standard Length Tolerance in Centimeters	
from 12 to 100 cm	0/+2.4 cm
from 100 to 1500 cm	0/+3.4 cm
from 1500 to 3000 cm	0/+4.4 cm
from 3000 to 5000 cm	0/+17.4 cm

To validate your part number please contact your local Radiall representative.

Technical datasheets are available upon request.

Specific requirements such as additional testing, specific labeling and additional protection of the cable can be accommodated as a custom cable assembly.

Harsh Environment Cable Assemblies

MT BASED CABLE ASSEMBLIES

Radiall is designing, manufacturing and delivering rugged cable assemblies equipped with MT ferrule interconnect solutions. Widely used in telecom and data center applications, the MT ferrule provides high density interconnection which makes it also attractive for aerospace and defense applications.

MT Ferrule Key Features and Benefits:

- High density
- Lightweight interconnection
- Physical contact termini providing low optical losses

Applications:

- Active Component interface
- Radars
- IFE (In Flight Entertainment)
- Displays

To answer customer needs for an end-to-end solution, Radiall is developing a full range of interconnect solutions around the MT ferrule in correlation with Optical Active Components. Refer to Section 10, Active Components, for more detail on emitters, receivers and transceivers product lines.

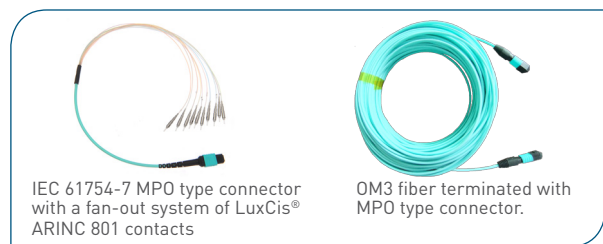
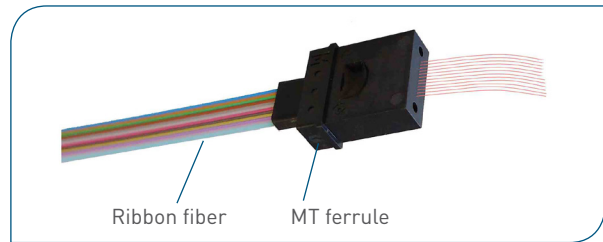

MT Fan-out Configurations:

Radiall's fan-out configuration enables transition from a high density 12 channel ribbon or round cable to singularly fanned-out round fibers, terminated with the best fitted connectors according to the application and customer needs.

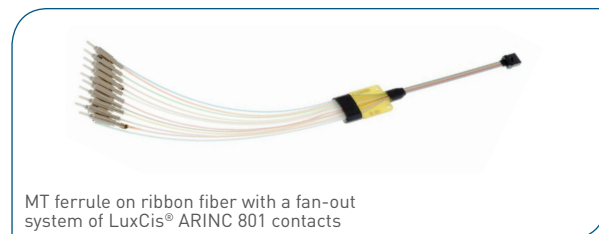

MT Interconnect Solutions:

The MT Cis, MT Cartridge Interconnect Solution, expands the range of applications of the MT ferrule in harsh environment applications.



Radiall MT-Cis protects a standard MT ferrule and enables enhanced alignment of the fibers to maintain excellent optical performance in harsh environmental and mechanical conditions. This unique design is meant to be used inside the box in mating adapters, board connectors (VITA type) or in multipin connectors.

Features:

- MT-Cis to be used in a variety of connectors and adapters
- Compatible with ribbon cords and round cables
- Easy insertion/extraction latching mechanism
- Perfectly suited to terminate pigtailed D-Light multichannel transceivers

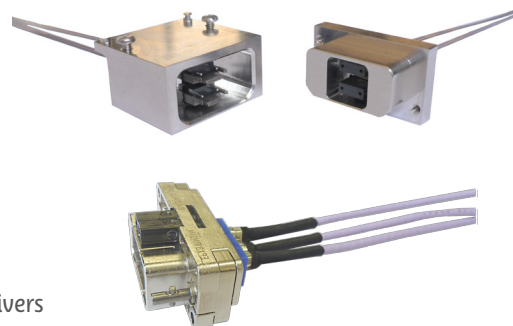

For any additional information, please contact your local Radiall representative.

Harsh Environment Cable Assemblies

EB BASED CABLE ASSEMBLIES

Radiall designs, manufactures and delivers cable assemblies with Expanded Beam interconnect solutions. The Expanded Beam offer for harsh environments includes 2 product ranges: the EB-LuxCis® product range and EB contacts interconnect solutions.

EB-LuxCis® Product Range:

The EB-LuxCis® product range combines the widely used LuxCis® ARINC 801 fiber optic contact inserted in a 2 or 4 channel (MM or SM) Expanded Beam insert, which can be used in various circular or rectangular connectors.

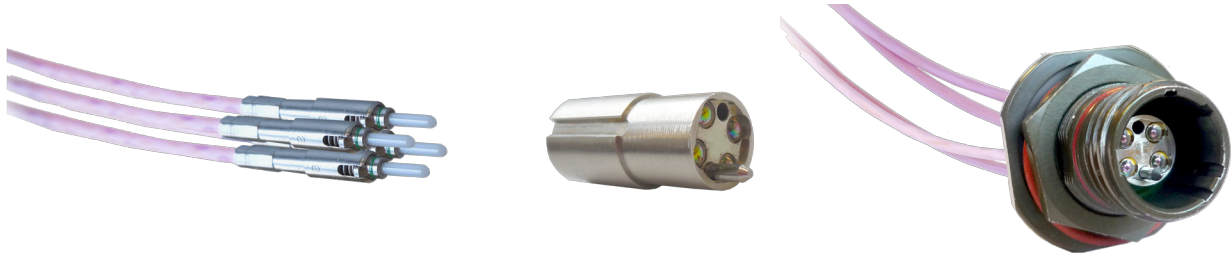

MIL-DTL-38999 size 11 connector



EN 4165 module

The EB-LuxCis® features a variety of multipin connectors such as MIL-DTL-38999, EN4165 modules, EPX® EN4644 and NSX ARINC 600. For any additional information, please contact your local Radiall representative.

EB Contacts for Multipin Connectors:

Radiall also provides cable assemblies with EB contacts for MIL-DTL-38999 connectors. Expanded Beam contacts fit in standard size 16 electrical cavities to incorporate EB technology in these multipin connectors.



EB contacts are also available for other multipin connectors. For any additional information, please contact your local Radiall representative.

Tactical Cable Assemblies

PRESENTATION

Radiall produces high quality tactical cable assemblies for a wide range of demanding military and harsh environment field applications.

Two main technologies exist in fiber optic connections for tactical environments: Physical Contact technology and Expanded Beam technology. Radiall will use the best of both alternatives to deliver ruggedized and field deployable cable assemblies.

Tactical cable assemblies operate in unstable and severe environmental conditions, such as in radars, military radio communication, intercom systems and many other applications.

Defense



Typical Requirements for Harsh Environment Applications

- Fast and trouble-free integration in the field
- Easy to use and trouble-free maintenance
- Extremely high mating durability
- Less sensitivity to pollution, dirt and dust
- Ruggedized connection, high resistance to crushing and shock
- High tensile strength

Radiall Key Factors

- Proven technology with high quality components for harsh environments
- Easy to integrate with hermaphroditic connections enabling blind mating and daisy chaining
- Application, environmental factors and costs are considered throughout design to provide an optimal solution
- Field support and training
- Turnkey factory assembled cable assemblies

Radiall Guarantee of Quality

- Tactical cable assemblies are visually inspected and tested per the criteria from the relevant industry standards
- We can deliver test measurement data with detailed reports on the performance of the cable assemblies
- Radiall can conduct other tests according to your requirements upon request



Tactical Cable Assemblies

COMPONENTS FOR TACTICAL CABLE ASSEMBLIES

Typical Optical Fibers:

Radiall can accommodate various types of fiber, including the most popular fibers used for data transmission:

- SingleMode 9/125 μm
- MultiMode 50/125 μm OM2, OM3 and OM4
- MultiMode 62.5/125 μm or larger core fiber

Typical Cables for Tactical Applications:

- Military tactical multi-fiber cables including anti-rodent, high crush resistance or armored cables
- Outdoor multi-fiber cables
- Various cable diameters can be accommodated

For any other requests or specific cable requirements, please contact your local Radiall representative.

Typical Connectors for Tactical Applications:

- Tactical Expanded Beam connectors (refer to Section 3, Expanded Beam Solutions, for more detail)
- LuxCis® ARINC 801 interconnect product range (refer to Sections 1 and 2 for more detail on LuxCis® ARINC 801 contact and interconnect solutions)
- Ruggedized LC, SC, ST and FC connectors (refer to Section 4 for more detail on LC, SC and ST connectors)



Radiall can produce many other connectors or contacts. Please contact Radiall for more information.

CHARACTERISTICS OF TACTICAL EXPANDED BEAM CONNECTORS

OPTICAL CHARACTERISTICS

	MultiMode PC 1300 nm	SingleMode PC 1310 nm
Insertion Loss* (typical)	0.7 dB	0.7 dB
Insertion Loss (maximum)	1.5 dB	2 dB
Return Loss**		>34 dB

*When tested with reference quality launch/receive cable assemblies

**RL tested unmated

ENVIRONMENTAL AND MECHANICAL CHARACTERISTICS

Operating Temperature Range	-40°C/+85°C
Mating Endurance	Up to 3000 mating cycles



Tactical Cable Assemblies

HOW TO ORDER

Use this configurator to define a part number for standard tactical cable assemblies using Expanded Beam Junior size tactical connectors. EB Junior size tactical connectors are designed to MIL-DTL-83526/20 & /21 mechanical interface standards.

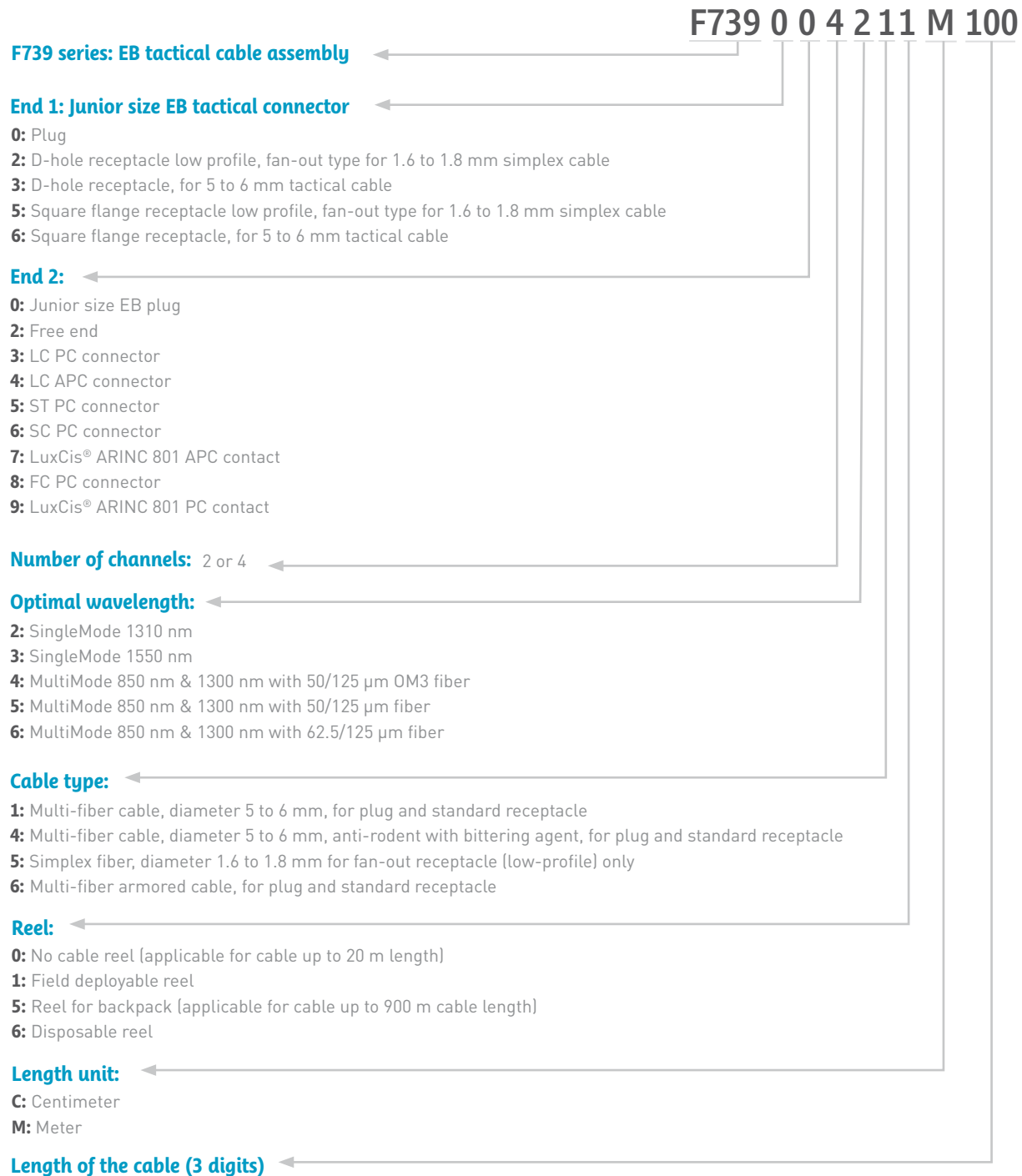

Each cable assembly is labeled with a heat shrink sleeve with Radiall PN and date code. For any other cable assembly configuration or specific requirements (additional testing, specific labeling, additional protection or different type of cable), please contact your local Radiall representative and a TDS for validation will be provided.

Tactical Cable Assemblies

ACCESSORIES

Radiall provides cable assemblies with various field orientated accessories such as reels and backpack reels.

Standard cable drums are available in 2 sizes:

Gantry Reel – size A

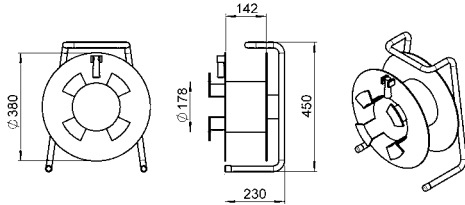

Gantry Reel – size B

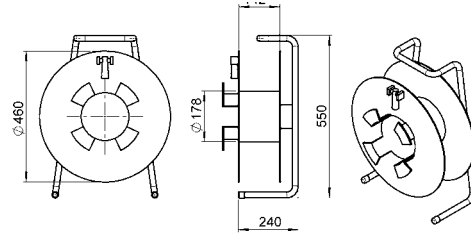

Gantry drum, with braking device and handle crank

	Size A	Size B
Color	Black	
Weight	5.90 kg	8.20 kg
Return Loss (RL)	Up to 280 m (with a 6 mm cable)	Up to 450 m (with a 6 mm cable)



RANGE EXTENSION

Not all accessories are displayed in this catalog.

Radiall is also designing other Expanded Beam solutions that provide:

- Smaller size with the mini insert (shrunken version of the Junior insert)
- More channels
- Hybrid configurations
- Environment specific designs

For any additional information, please contact your local Radiall representative.

Harnesses and Optical Systems

PRESENTATION

Radiall also manufactures high performance optical systems, boxes and complex harnesses for the various market segments. Designs are based on customer prints or designed by Radiall to meet customers' requirements and specific applications. Having 40 years of experience in fiber optic technology, Radiall's optical systems demonstrate our expertise and technical know-how. Radiall's worldwide presence and expertise has made us the supplier of choice for major companies all around the globe.



Aerospace Defense Industrial Telecom



Radiall Key Factors

Radiall provides a complete solution to address the most complex optical design requirements. From the design, materials sourcing, prototyping and full-scale production, Radiall handles it all whether it's simple point-to-point or complex multi-branch optical systems.

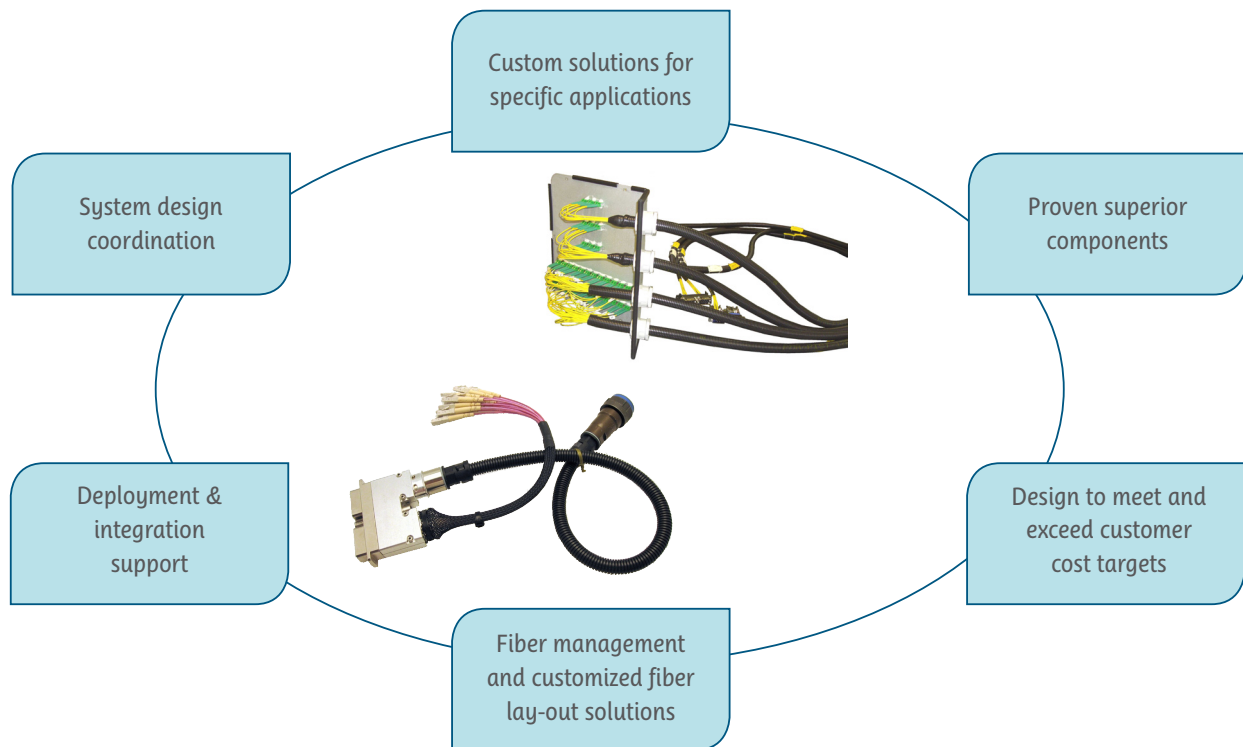

Radiall Guarantee of Quality

- Optical systems are visually inspected and tested per the criteria from the relevant industry standards (ARINC, EN, SAE, IEC)
- All products are manufactured in AS9100 certified assembly lines
- Radiall can deliver test measurement data with detailed reports on the performances of the cable assemblies
- Radiall can conduct other tests according to requirements upon request

Our Most Important Connection is with You.™

Harnesses and Optical Systems

COMPONENTS FOR HARNESSES AND OPTICAL SYSTEMS

Typical Optical Fibers:

Radiall can accommodate various types of fiber, including the most popular fibers used for data transmission:

- SingleMode 9/125 μm
- MultiMode 50/125 μm OM2, OM3 and OM4
- MultiMode 62.5/125 μm or larger core fiber

Typical Cables for Harnesses and Optical Systems:

- Simplex, duplex and multi-fiber cables
- Loose, tight and ultra tight structure cables
- Aerospace grade cable temperature range (-55°C/+125°C)
- Ruggedized telecom cables for outdoor applications

Note: Standard temperatures are listed above but higher temperatures can be achieved with specific cables.

Polishing Processes Available:

Depending on the customer’s needs and according to the application, the following process can be used:

- PC: Physical Contact for MultiMode or SingleMode connection
- UPC: Ultra Physical Contact for SingleMode or MultiMode
- APC (8°): Angled Physical Contact for SingleMode. For higher performance of Return Loss due to the angled end face.

TYPICAL CONNECTORS FOR HARNESSES AND OPTICAL SYSTEMS

Circular Connectors



Single channel LxC-R® connectors



MIL-DTL-38999 type connectors

Rectangular Connectors



EPX®/EN4644 connectors

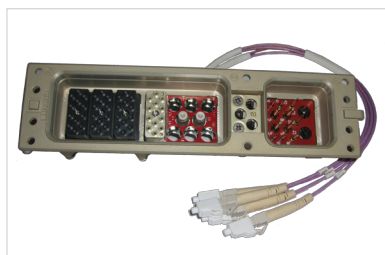

NSX/ARINC 600 connectors



DSX/ARINC 404 connectors

Radiall can produce and supply many other connectors or contacts. Please contact your local Radiall representative for more information.

Harnesses and Optical Systems

HYBRID ELECTRICAL/OPTICAL SYSTEMS

Radiall has the expertise to provide hybrid solutions for harsh environments. The use of hybrid components can reduce the overall system size and complexity. Knowledge of both technologies allows Radiall to offer customers electrical/optical systems.

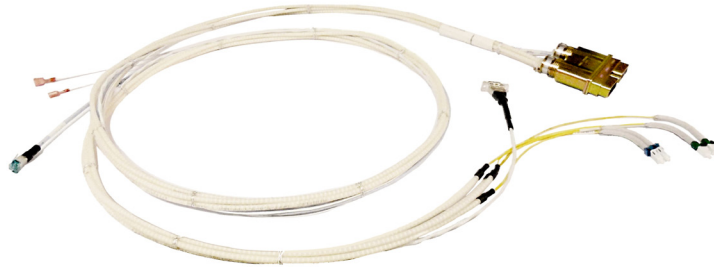

Electrical/optical systems combining EPX® connectors, LuxCis® ARINC 801 contacts, LC connectors and electrical components



EPX® connector with mixed electrical and LuxCis® ARINC 801 optical contacts

FIBER MANAGEMENT AND OPTICAL SOLUTIONS LAYOUT

Fiber management and routing are key to an optimal optical system.

Radiall delivers the optimal solution to handle, protect and improve the performance and longevity of your system.

Radiall's dedicated engineering teams:

- Analyze the project
- Source the necessary components and materials within Radiall's extensive range of products and on the market
- Devise a complete solution to ease access, repair-ability and modularity in dense circuitry with wiring schematics, fiber protection and routing instructions

Radiall's capabilities:

- Boxes design and assembly
- Optical backplanes
- Backshell design
- Optical flexible circuits
- Tray and modules to improve fiber management

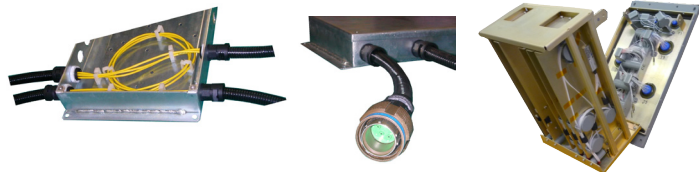

ACCESSORIES AND PROTECTION

Radiall can also provide a wide range of accessories, cable protection, backshells and customized protection.



Radiall has developed various backshells designed for Radiall rectangular and circular connectors with higher strain relief performance.



For more information about optical system configuration, please contact your local Radiall representative.

Notes

SECTION 10

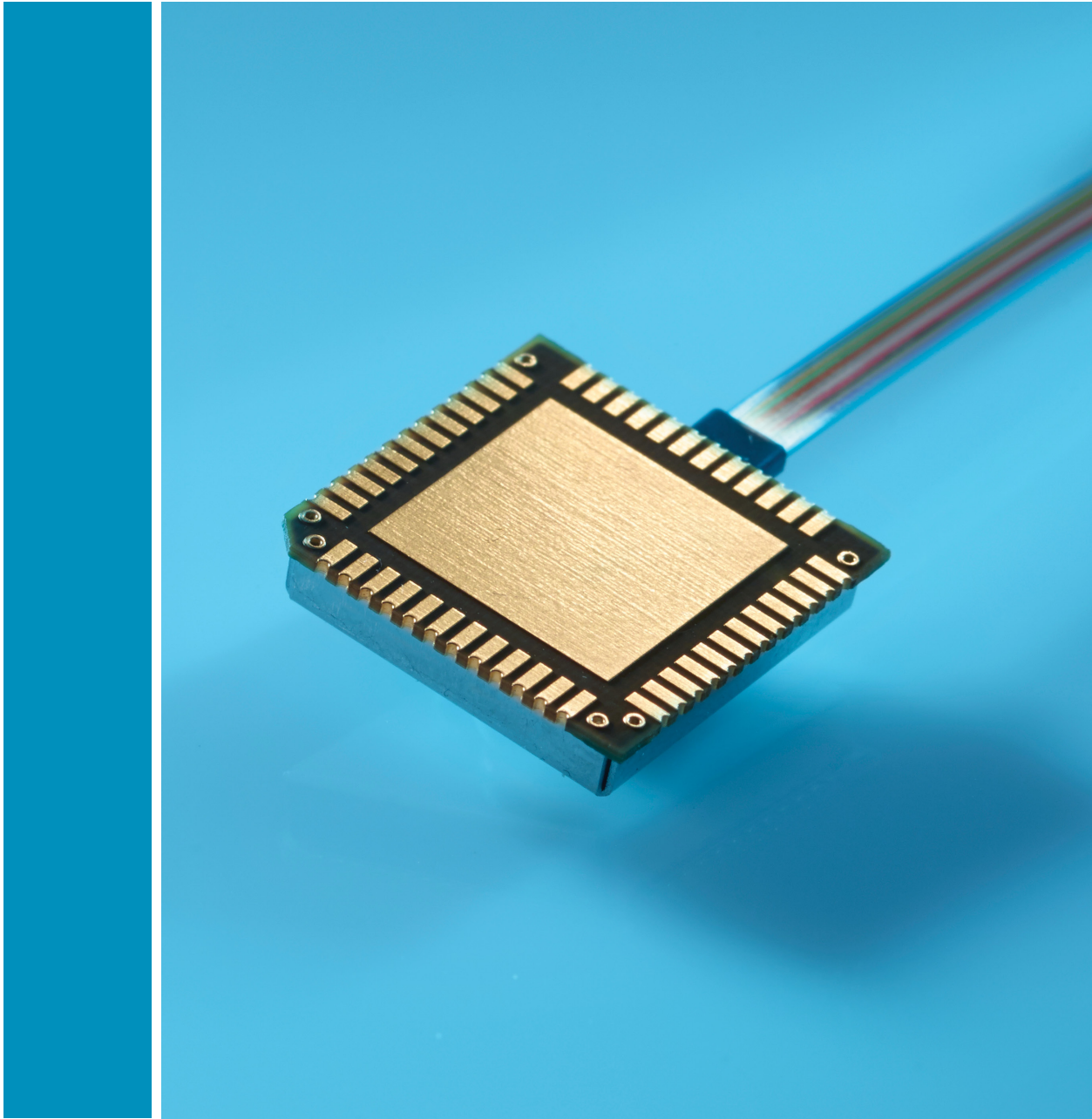

Active Optics



Contents

Introduction

Markets and Applications	10-2
Internal Standard Documents Compliance	10-2
Features and Benefits	10-2
Product Range Overview	10-2

S-Light

Features	10-3
Key Parameters	10-3
Available Options	10-3 to 10-4
Part Number Builder	10-5

D-Light

Key Parameters	10-6
Available Options	10-6 to 10-7
Part Number Builder	10-8 to 10-10

Evaluation Boards and Tooling	10-11
-------------------------------------	-------

Introduction



With its D-Lightsys® range, Radiall offers optical transceiver components dedicated to harsh environments within the aerospace, space and defense markets. The optoelectronic D-Lightsys® modules are among the best performing in the world with very low power consumption and a minimum footprint. A complete range, from the transceiver to multichannel products, allows these devices to meet performance requirements in a large number of stringent applications.

They are dedicated to high speed data communications and provide data rates from 0.1 to 10 Gbps. D-Lightsys® modules offer high performance at very low consumption levels. Operational temperature from -55°C to +125°C and highly resistant to shock and vibrations, they can withstand the most demanding environments with unrivaled reliability. Modules are qualified per various MIL-AERO standards (ARINC 804) and are 100% tested over the whole operating temperature range. A full range of evaluation boards are also available for testing the D-Lightsys® modules.

MARKETS AND APPLICATIONS

D-Lightsys® devices are robustly designed for use in harsh environment applications such as:

Civil Aerospace

Airframe, avionics, In-Flight Entertainment (IFE), Heads Up Display (HUD), Power and flight management, pressurized/unpressurized areas transmissions, sensors

Military Aerospace

Avionics, weapons systems, power and flight management, sensors

Data Transmissions

High speed data networking

Radars

Remote antennas, phase array radar, satellite

Navy & Shipboard

Missile systems, communication

Geophysics

Oil and gas, mining, exploration with streamers arrays, roofers and shearing equipment



INTERNATIONAL STANDARD DOCUMENTS COMPLIANCE

- IEEE standard 802.3z Gigabit Ethernet 1000 Base-Sx PMD
- ARINC 804, 815, and 818 standards
- Control and monitoring compliant with SFF-8472 standard



FEATURES AND BENEFITS

- Data rate up to 10 Gbps
- Use 850 nm VCSEL emitters
- Control and monitor compliant with MSA SFF-8472
- Monitoring of the optical power of emitters over the temperature range
- Low power consumption
- Standard electrical SMT interface or solderless interface option
- Pigtailed optical interconnect solutions (MultiMode fibers)
- Very small form factor

PRODUCT RANGE OVERVIEW

D-lightsys® products are divided in two main families:

- S-light: single channel modules
- D-light: multichannel modules

S-Light



The S-Light range includes single channel optical transceivers for harsh environment applications available in transmitter, receiver and transceiver modules. Several package options are offered from surface mount, pluggable and custom packages.

FEATURES

- Uses 850 nm VCSEL'S
- Controls and monitoring compliant with SFF-8472 standard
- Monitoring of the optical power over the temperature range
- Standard electrical SMT interface or pluggable interface option
- Provided with 50/125 μm or 62.5/125 μm optical fiber

All the D-Lightsys® devices can be fully monitored and/or controlled through a I²C 2-wire serial interface and are suitable for a variety of applications:

- Average and modulation currents of the VCSEL laser are both digitally programmable through the 2-wire serial interface.
- A versatile input stage allows 100 Ω differential or 50 Ω to ground termination resistors to comply with CML or LVDS signaling levels.
- Analog outputs allow the monitoring of the module state and performance.

KEY PARAMETERS

Parameters	Value	Units	Notes
Data rate (max)	10	Gbps	2 ranges available 0.1-4.25 Gbps 0.5-10 Gbps
Transceiver case operating temperature	-55/+125	°C	Qualified temperature range -40°C/+90°C
Power supply voltage	3.3	V	
Transceiver power consumption (max)	<300	mW	Over the full temperature range
Average output power (min)	-4	dBm	S-Light family transmitters are Class 1M laser products according to IEC 60825-1 standard
Optical extinction ratio	9	dB	@2.5 Gbps ER= 5 dB @10 Gbps
Optical sensitivity	-20	dBm	@2.5 Gbps, for BER=10 ⁻¹² measured with a 2 ⁷ -1 PRBS signal -10 dBm @ 10 Gbps

Detailed technical datasheets are available upon request. Please contact your local representative.

AVAILABLE OPTIONS

Part Definition	Available Options	Description
Module type	Transmitter	1 emitting channel (1 fiber)
	Receiver	1 receiving channel (1 fiber)
	Transceiver	1 emitting channel + 1 receiving channel (2 fibers)

For any additional information, please contact your local Radiall representative.
Reliability and qualification reports are available upon request.

S-Light

Available Package Options	Dimensions	
48 pin LCC package (Direct board soldering)		
10 pin SFF package		
40 pin SAMTEC YFT (Socket pluggable)		
40 pin SAMTEC YFT (Narrow socket)		

AVAILABLE TERMINI/CONNECTORS:

- LuxCis® ARINC 801/EN4639
- ABS1379/EN4531
- LC
- FC
- ST
- SC

AVAILABLE OPTICAL FIBERS:

- MultiMode 50/125 µm OM2
- MultiMode 62.5/125 µm



For any additional information, please contact your local Radiall representative.

S-Light

SINGLE-CHANNEL OPTICAL TRANSMITTERS, RECEIVERS AND TRANSCEIVERS FOR HARSH ENVIRONMENTS

PART NUMBER BUILDER

SLx-www-Ix-Pyz-Lvv

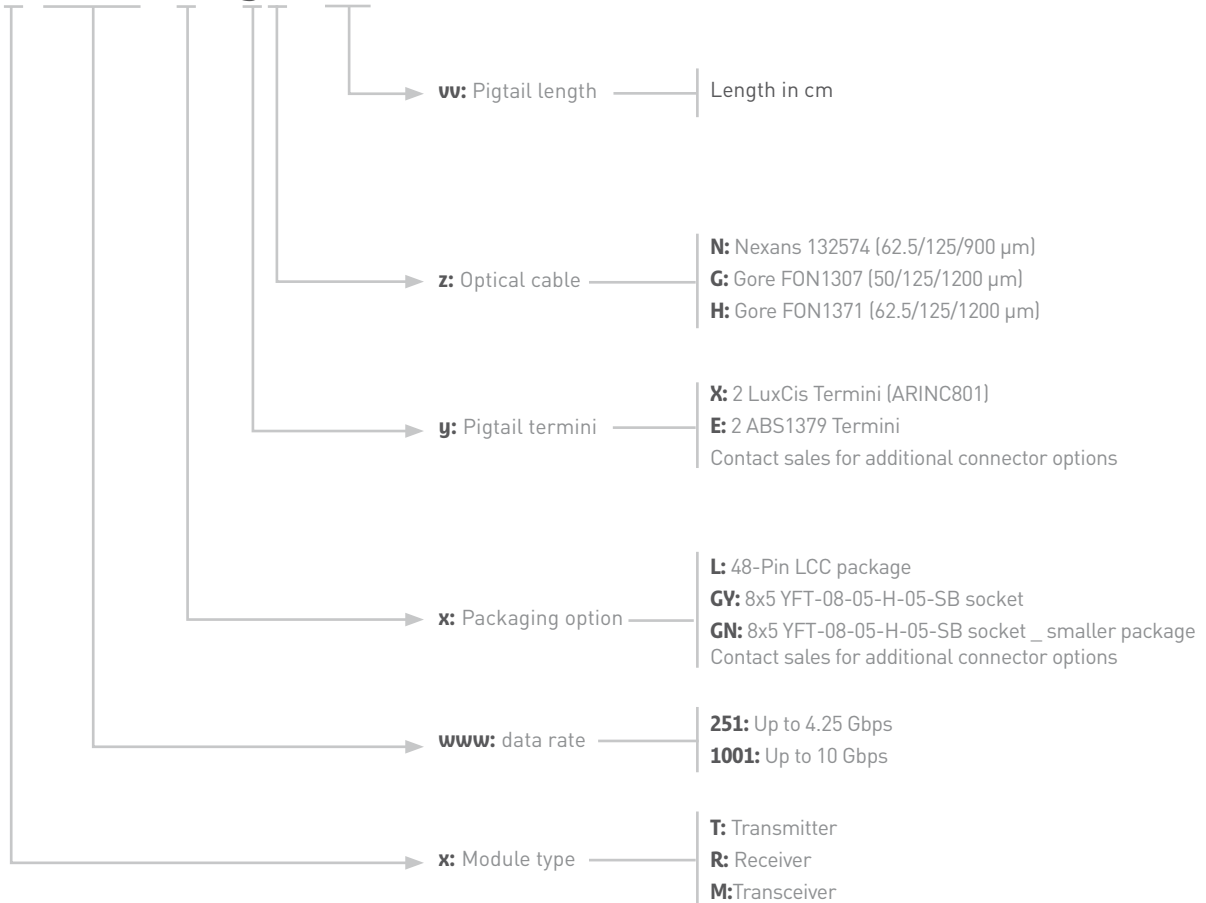

To validate your part number please contact your local Radiall representative. Technical datasheets are available upon request.

D-Light

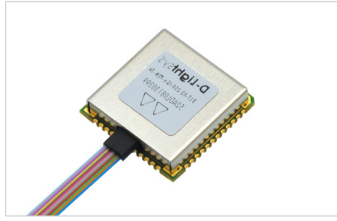

The D-Light range includes multi channel optical transceivers for harsh environment applications available in transmitter, receiver and transceiver modules with 4 channels (4 Rx + 4 Tx). Several package options are offered from surface mount to pluggable packages.

KEY PARAMETERS

Parameters	Value	Units	Notes
Data rate (Max)	10	Gbps	Several ranges available For emitters & receivers: 0.1-4.5 Gbps (per channel) 0.5-10 Gbps (per channel) For transceivers: 0.1-3.25 Gbps (per channel) 0.5-10 Gbps (per channel)
Transceiver case operating temperature	-55/+100	°C	Qualified temperature range -40°C/+85°C
Power supply voltage	3.3	V	
Transceiver power consumption (Max)	125	mW	Over the full temperature range per channel
Average output power (min/channel)	-4	dBm	D-Light family transmitters are Class 1M laser products according to IEC 60825-1 standard
Optical extinction ratio	9	dB	@2.5 Gbps
Optical sensitivity	-19	dBm	@2.5 Gbps, for BER=10 ⁻¹² measured with a 2 ⁷ -1 PRBS signal -16 dBm @ 3.25 Gbps -12 dBm @ 10Gbps

AVAILABLE OPTIONS

Part Definition	Available Options	Description
Module type	Transmitter	2 or 12 emitting channels
	Receiver	2 or 12 receiving channels
	Transceiver	4 emitting channels + 4 receiving channels

Reliability and qualification reports are available upon request.

For any additional information, please contact your local Radiall representative.

D-Light

Available Package Options	Dimensions	
48 pin LCC package		
100 pins package		

AVAILABLE TERMINI/CONNECTORS:

- 12 channels optical connector: MPO and/or connector compliant with IEC Standard 61754-7 and TIA 604-5
- 12 channels optical ferrule: MT ferrule only or MT ferrule with Radiall MT cartridge

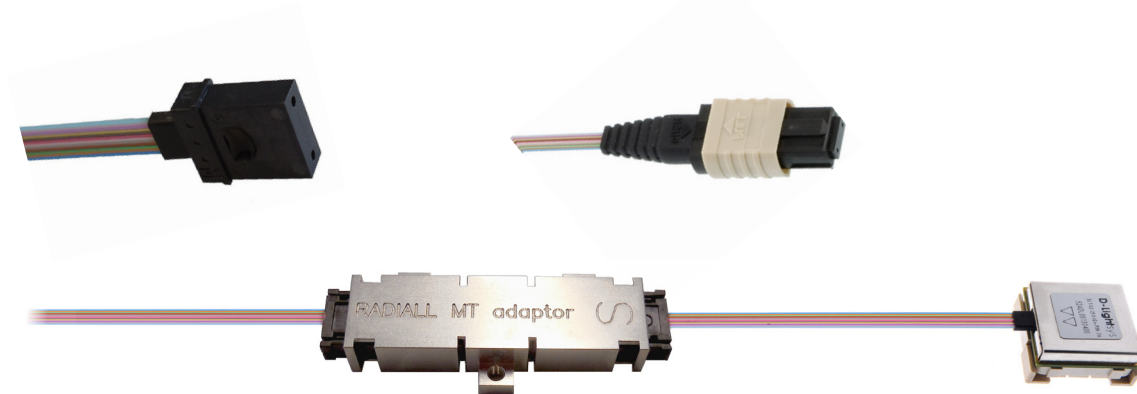

AVAILABLE OPTICAL FIBERS:

- MultiMode 50/125 µm OM2 - ribbon 12 fibers (single fiber cable is available for DLR-02/DLT-02)
- MultiMode 62.5/125 µm - ribbon 12 fibers (single fiber cable is available for DLR-02/DLT-02)

For any additional information, please contact your local Radiall representative.

D-Light

MULTI-CHANNEL OPTICAL TRANSMITTERS FOR HARSH ENVIRONMENTS

PART NUMBER BUILDER

DLT-cc-www-Ix-Pyz-Lvv

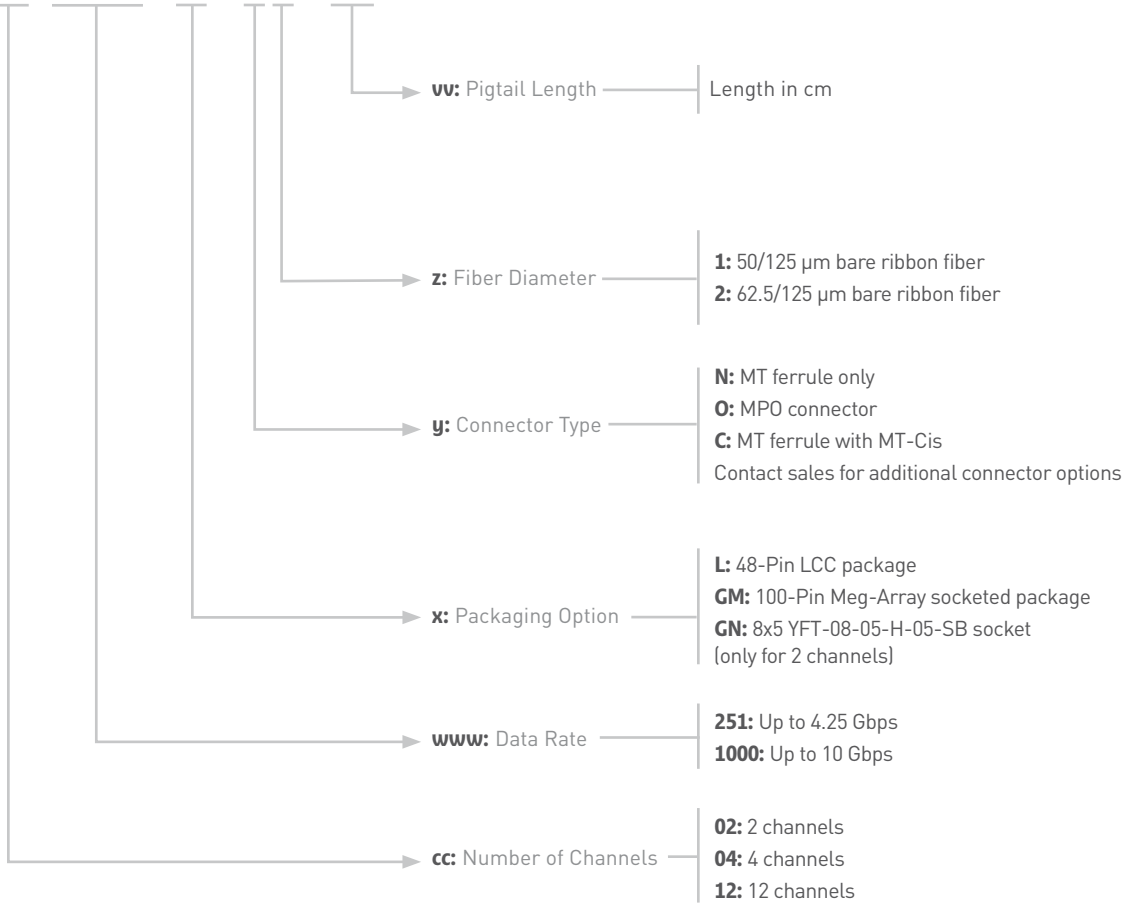

To validate your part number please contact your local Radiall representative. Technical datasheets are available upon request.

MULTI-CHANNEL OPTICAL RECEIVERS FOR HARSH ENVIRONMENTS

PART NUMBER BUILDER

DLR-cc-www-Ix-Pyz-Lvv

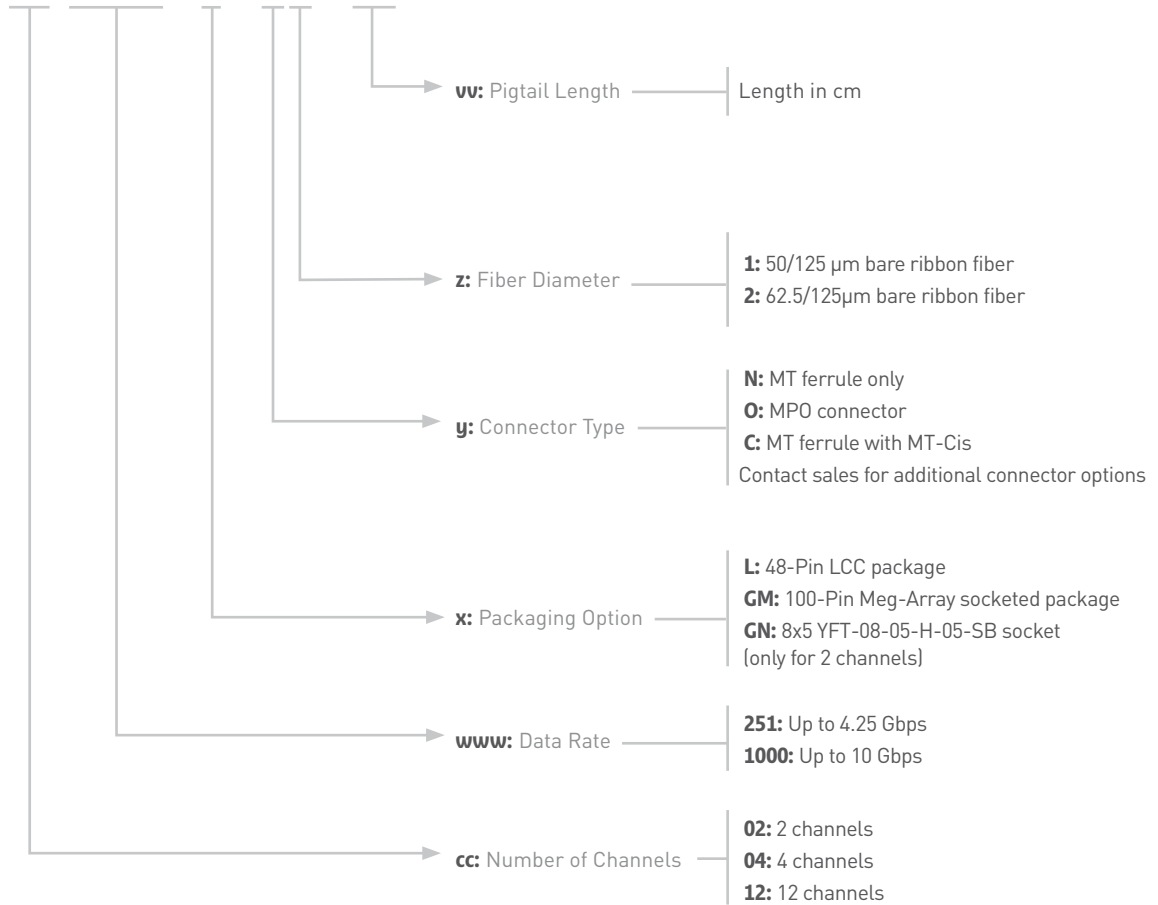

To validate your part number please contact your local Radiall representative. Technical datasheets are available upon request.

D-Light

MULTI-CHANNEL OPTICAL TRANSCEIVERS FOR HARSH ENVIRONMENTS

PART NUMBER BUILDER

DLM-cc-www-Ix-Pyz-Lvv

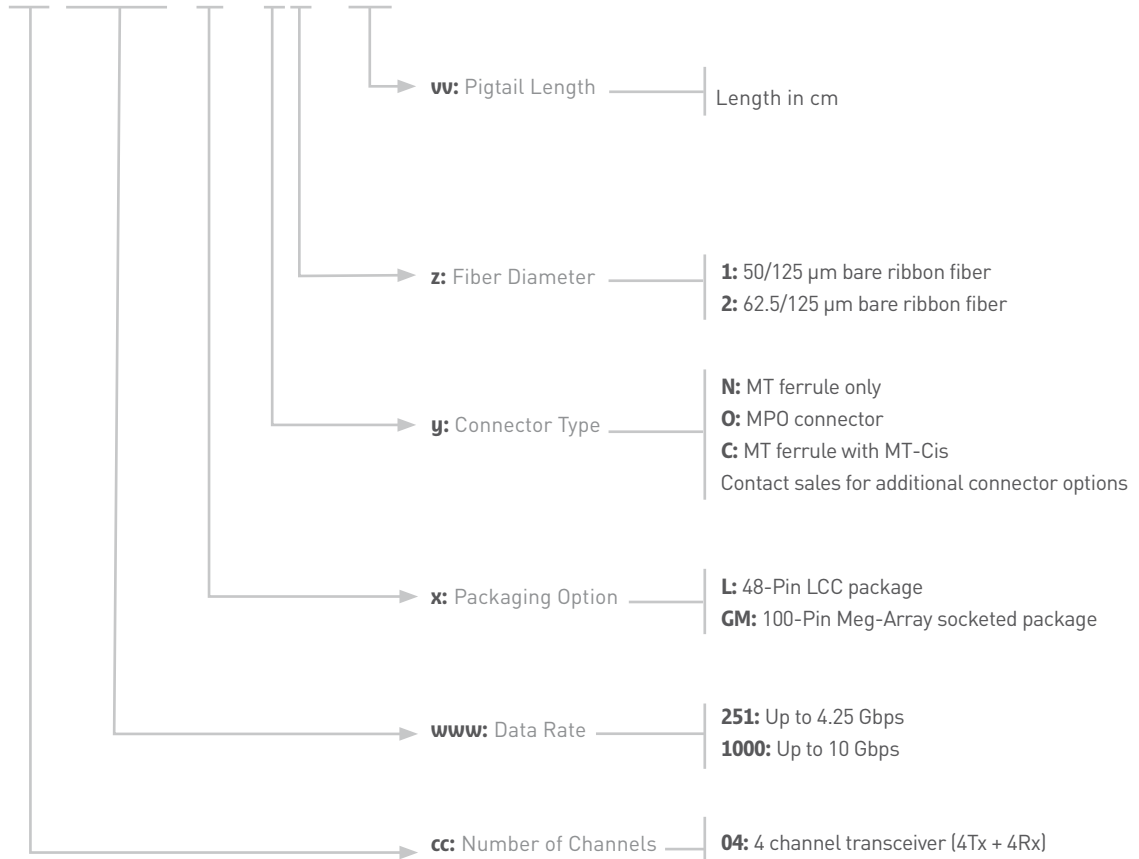

To validate your part number please contact your local Radiall representative. Technical datasheets are available upon request.

Evaluation Boards and Tooling

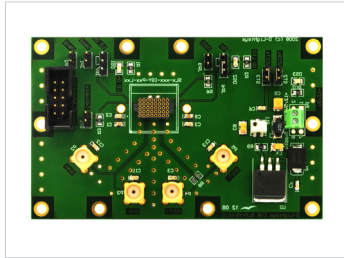

Radiall offers a full range of evaluation boards enabling full monitoring of S-Light and D-Light modules, either for the pluggable package or for the LCC package.

A Windows PC-Based software is available for complete module monitoring and control.

Application notes for layout considerations are also available. Please contact your local representative for more information.

GENERAL EVALUATION BOARD SPECIFICATIONS

Parameter	Symbol	Min	Type	Max	Unit
External supply voltage	VCC	1.2	7.0	15	V
Supply voltage noise	NVCCx	-	-	150	mV
Supply current (Tx + Rx)	ICC	-	-	500	mA
Operating temperature	Top	-40	-	+100	°C

Notes



Tool kits and Accessories

F718, F780



Contents

Inspection and Cleaning	
Features and Benefits	11-2
Standards	11-2
Product Range Overview	11-4
LuxCis® ARINC 801 Inspection and Cleaning Kits	11-5
Inspection Assistant Kits for LuxCis® ARINC 801	11-6
Cleaning Materials.....	11-7
Inspection Tools	11-8
Accessories for Digital Microscope Probe	11-9
Termination	
Features and Benefits	11-9
Standards	11-9
Product Range Overview	11-9
LuxCis® ARINC 801 Termination Kits	11-10
LuxCis® ARINC 801 Polishing Kit	11-11
LC Termination Kit	11-12
SC, FC and ST Termination Kit	11-13
Miscellaneous Tools	11-14
Master Cords	
Introduction	11-15
Features and Benefits	11-15
International Standard Documents Compliance.....	11-15
End Face Geometry	11-15
Optical Performance	11-15
Mechanical and Environmental Characteristics	11-15
LuxCis® ARINC 801 Master Cords	11-16
LC Master Cords	11-16
SC Master Cords	11-17
ABS1379 EN4531 Master Cords	11-17

Inspection & Cleaning



A good maintenance is crucial to maintain high optical performance and the longevity of optical systems. To assist our customers and partners in maintenance and integration of their optical solutions, Radiall provides an extensive range of tools and kits. Radiall combines its expertise, experience and innovative take on fiber optics to design the Inspection and Cleaning kits featuring state of the art tools, high quality materials and detailed procedures.

All our field adapted and convenient kits are the optimal solution to prevent and eliminate the main issue in any fiber optic network: contamination.

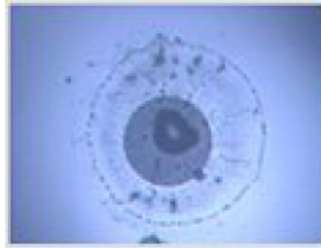

Connector end face
before cleaning

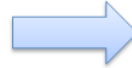

Connector end face
after cleaning

FEATURES AND BENEFITS

Versatile

- Adapted to either MultiMode, SingleMode PC and APC terminations
- Various kit configurations available, products can also be ordered separately
- Well adapted to field and laboratory environments

Effective

- Able to perform dry and wet cleaning techniques
- Cleaners specifically formulated to dissipate static
- Lint-free cleaning materials, no fiber, no adhesive and no residue, won't shred or tear
- Cleaning materials feature no seam nor sharp surface
- Cutting edge inspection tools and software

Handy

- Enable inspection and cleaning through sleeve holders
- Tools and materials designed conform to the optical end face and connectors cavities, with specific markings if necessary
- Plastic case with custom foam interior for easy product organization, protection and portability
- Detailed and illustrated procedure
- All tools and consumables are compatible with air transportation

Field Compatible

- Cleaning platform ideally adapted for field use
- Effective inspection and cleaning of fully accessible or hard-to-reach areas
- Field designed, rugged and water-proof inspection tools

STANDARDS

LuxCis® ARINC 801 Inspection and Cleaning kits are developed according to ARINC 805-3 "Fiber Optic Test Procedures" report. Tools and materials are RoHS compliant.





Inspection & Cleaning

PRODUCT RANGE OVERVIEW

Our kits are offered in various configurations:

- **PREMIUM Inspection & Cleaning kit** with all items for optimal maintenance of optical contacts, including a digital microscope probe combined with its handheld video display.
- **Inspection & Cleaning kit** with all items for optimal maintenance of optical contacts, including a digital microscope probe (the handheld video display is not included in this kit).
- **Cleaning supplies kit** with all cleaning materials to replenish the above premium and standard kit.

Series	Description	Part Number
 <p>LuxCis® ARINC 801</p>	PREMIUM Inspection & Cleaning kit	F780 538 000*
	Inspection & Cleaning kit	F780 539 000*
	Cleaning supplies kit	F780 541 000*
	Inspection Assistant Guide for LuxCis® ARINC 801 in R8/MIL-DTL-38999 type connector	F780 726 200*
	Inspection Assistant Guide for LuxCis® ARINC 801 in EPX® connector	F780 725 300*
 <p>ABS1379 EN4531</p>	PREMIUM Inspection & Cleaning kit	F780 533 001
	Inspection & Cleaning kit	F780 533 002
	Cleaning supplies kit	F780 533 003
 <p>29504 type termini</p>	PREMIUM Inspection & Cleaning kit	F780 428 000
	Inspection & Cleaning kit	F780 429 000

*Refer to the following pages for more detail and kit content

A wide range of inspection tools and cleaning materials are available for other series, please refer to the following pages.

Inspection & Cleaning

LUXCIS® ARINC 801 INSPECTION & CLEANING KITS

As contamination may dramatically affect the optical performance of your optical link, previous to mating any optical connection, it is highly recommended to inspect and clean (if necessary) the optical end faces. This recommendation is described in Radiall procedures and universal standards such as ARINC and EN specifications.

The LuxCis® kits contain everything needed for an easy and efficient inspection and cleaning process of the LuxCis® ARINC 801, including specifically engineered tips for using a digital microscope to inspect EPX® and MIL-DTL-38999/R8 sleeve holders and single channel LxC-R® connector plugs.

3 versions:

- F780 538 000: PREMIUM Inspection & Cleaning kit (with handheld video display)
- F780 539 000: Standard Inspection & Cleaning kit (without handheld video display)
- F780 541 000: Cleaning supplies kit (for inspection & cleaning kits replenishment)

KITS CONTENT:

Part Number	F780 538 000	F780 539 000	F780 541 000	Description	Picture
282 515	•	•	•	3 plastic insertion/extraction tools, size 16 (MIL-PRF-81969/14-03)	
F718 176 104	•	•	•	Bag of 10 protective dust caps for LuxCis® ARINC 801 contacts	
F780 904 000	•	•	•	Fiber wash cleaning pen	
F780 902 000	•	•	•	Fiber optic cleaning platform with wipes and pad	
F780 905 000	•	•	•	Pack of 100 cleaning sticks	
F780 903 000	•	•	•	Pack of 50 optical face cleaning swabs	
F780 906 001	•	•		Mechanical stick cleaner	
F780 890 000	•	•		Tip for PC terminus for digital probe	
F780 891 000	•	•		Tip for APC terminus for digital probe	
F780 898 000	•	•		Narrow long type assembly barrel for digital probe	
F780 906 002	•	•		Tip for PC terminus for digital probe =>To inspect through MIL-DTL-38999 sleeve holder and in LxC-R® plug	
F780 906 003	•	•		Tip for PC terminus for digital probe =>To inspect through EPX® sleeve holder	
F780 899 000	•			Fiber microscope 200x/400x digital probe with handheld video display	
F780 889 000		•		Fiber microscope 200x/400x digital probe (with USB plug)	
F780 897 000	•	•		Dynamometric screwdriver with hexagonal 5/64 inch (2mm)/flat tip	
503 08 590	•	•		Printed procedure	

Inspection & Cleaning

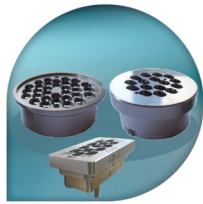

INSPECTION ASSISTANT KITS FOR LUXCIS® ARINC 801

To support and ease the inspection and cleaning process, Radiall has developed dedicated devices enabling trouble-free maintenance of the LuxCis® ARINC 801 contact inside multipin connectors: EPX® EN4644 and R8 MIL-DTL-38999.

With the inspection assistant guides, no need to take extra precaution when inspecting and cleaning your optical end face. This device can be used with the microscope probe included in Radiall Inspection & Cleaning kit (F780 538 000 and F780 539 000).

FEATURES AND BENEFITS

Swift and Easy

Optimizes inspection and cleaning process:

- No precaution needed
- No extra manipulation

Safe:

- No risk of damaging other ferrule while inspecting
- No direct contact between the probe tip and the termini end face

Ease of handling:

- Specific design and locking keys for an easy and perfect fit
- Guide cavities designed to permit the cleaning of the optical end face without removing the guide

A Complete Solution

- Adapted to **PC, UPC** and **APC** LuxCis® ARINC 801 contacts
- Available for **EPX®** and **MIL-DTL-38999** type connectors
- Inspection assistant guides available for **plugs** and **receptacles**
- Lay-outs available from **size 11 to 25 for MIL-DTL 38999**
- Inspection assistant guide compatible with optical or hybrid inserts
- Wide range of **dedicated tips** for digital probe is available, including angled tip for hard-to-reach areas.

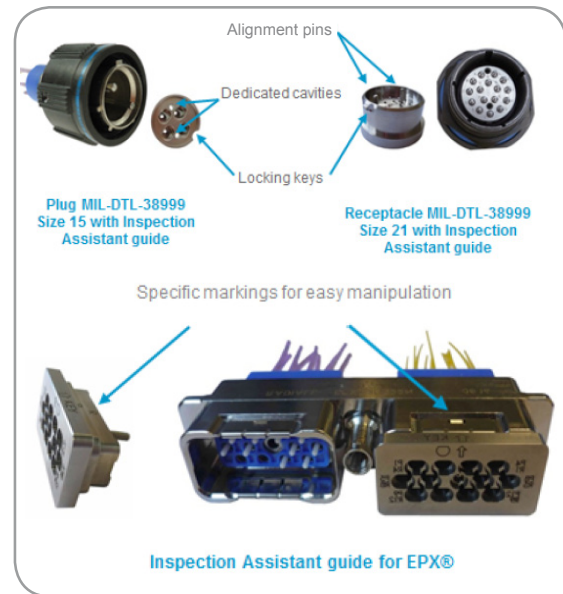

MIL-DTL-38999 type connectors



EPX® connectors



Inspection & Cleaning

PRODUCT RANGE

Assistant Inspection Guides are available in a complete kit or each item separately.

Series	Part Number	Description
Inspection assistant for LuxCis® inside R8 MIL-DTL-38999 type connectors	F780 725 200	Full kit including: - Guides for R8 plugs and receptacles from size 11 to 25 - Dedicated tips for microscope probe (F780 725 000 ⁽²⁾ for APC and F780 725 001 ⁽²⁾ for PC) - Cleaning sticks to clean the guides' cavities
	F780 725 0XX ⁽¹⁾	Individual guide for plug size X ⁽¹⁾
	F780 725 1XX ⁽¹⁾	Individual guide for receptacle size X ⁽¹⁾
Inspection assistant for LuxCis® inside EPX® connectors	F780 725 300	Individual guide for EPXB plug and receptacle
Tips for digital microscope probe	F780 725 001 ⁽²⁾	Tip for PC polishing
	F780 725 000 ⁽²⁾	Tips for APC polishing
	F780 898 001 ⁽²⁾	Angled tip for inspection of PC termini in hard-to-reach areas

⁽¹⁾Replace XX by the size (from 11 to 25) of the connector you wish to inspect and clean

⁽²⁾Tips to be assembled with the narrow long type barrel (F780 898 000) to be attached on the microscope probe

Accessories:

A lock-nut is available to make it more convenient while inspecting and cleaning in upside down situations.

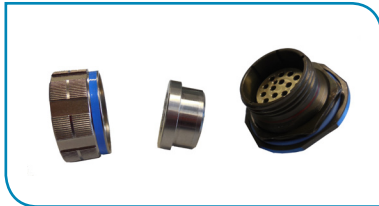









The lock-nut avoids the guide falling during inspection and cleaning and frees your hands for an easier handling of the probe.







Inspection & Cleaning

CLEANING MATERIALS











Series	Part Number	Description	Packaging	Picture
All series	F780 902 000	Fiber optic cleaning platform with wipes and pad	1	
All series	F780 904 000	Fiber wash cleaning pen	1	
All series	F780 905 000	Cleaning sticks	100	
All series	F780 903 000	Optical face cleaning swabs	50	
ABS1379 EN4531, SC, ST	F780 584 000	Set of cleaning tips	50	
LuxCis® ARINC 801 LC	F780 906 001	Mechanical stick cleaner for 1.25 mm ferrule termini	1	
ABS1379 EN4531, SC, ST	F780 906 005	Mechanical stick cleaner for 2.5 mm ferrule termini	1	
MIL-PRF-29504	F780 906 004	Mechanical stick cleaner for 29504 type termini	1	

INSPECTION TOOLS

Series	Part Number	Description	Picture
All series	F780 889 000	Fiber microscope 200x/400x digital analysis probe with handheld video display	
	F780 899 000	Fiber microscope 200x/400x digital analysis probe (with USB plug)	
LuxCis® ARINC 801, LC, MIL-PRF-29504	F780 898 000	Narrow long type assembly barrel for digital probe	
ABS1379 EN4531, SC, ST	F780 906 000	Short type assembly barrel for digital probe	

Inspection & Cleaning

ACCESSORIES FOR DIGITAL MICROSCOPE PROBE

Series	Part Number	Description	Picture
LuxCis® ARINC 801, LC	F780 890 000	Tip for 1.25 mm ferrule PC termini	
LuxCis® ARINC 801, LC	F780 891 000	Tip for 1.25 mm ferrule APC termini	
LuxCis® ARINC 801	F780 906 002	Tip for 1.25 mm ferrule PC termini (through MIL-DTL-38999 sleeve holder and in LxC-R® plug)	
LuxCis® ARINC 801	F780 906 003	Tip for 1.25 mm ferrule PC termini (through EPX® sleeve holder)	
LuxCis® ARINC 801	F780 725 001	Tip for 1.25 mm ferrule PC termini, with Inspection Assistant guide	
LuxCis® ARINC 801	F780 725 000	Tip for 1.25 mm ferrule APC termini, with Inspection Assistant guide	
LuxCis® ARINC 801, LC	F780 898 001	Angled tip for 1.25 mm ferrule, PC termini for inspection in hard-to-reach areas.	
ABS1379 EN4531, SC, ST	F780 890 002	Male tip for 2.5mm ferrule PC termini	
ABS1379 EN4531	F780 890 003	Female tip for 2.5mm ferrule PC termini	
MIL-PRF-29504	F780 906 006	Male tip for MIL-PRF-29504 termini	
MIL-PRF-29504	F780 906 007	Female tip for MIL-PRF-29504 termini	

Note: All the tips have to be used with the narrow long type assembly barrel, except for F780 890 002 and F780 890 003 which have to be used with the short type assembly barrel F780 906 000.

Cleaning materials and inspection tools are also available for other connectors and contacts (MT ferrule and MT based connectors, Expanded Beam contacts and connectors, etc.), don't hesitate to contact your Radiall representative.

Termination



Radiall has developed high quality Termination kits and established detailed procedures based on its own technical expertise and the available industry standards.

Radiall processes and tools have been optimized to provide a complete and efficient solution. Termination kits contain everything required to assemble fiber optic contacts and connectors.

FEATURES AND BENEFITS

- Contains everything needed to strip, mark, cure, cleave and terminate contacts and connectors.
- Adapted to any cable from buffer 900 µm to 3 mm diameter cable
- Detailed termination instructions
- Rugged carrying case safely stores and transports all tools and supplies (compatible with air transport)
- Field designed and rugged 220 Volts and 110 Volts curing unit available.
- Processes have been tested and approved by field technicians and Radiall's experts.

STANDARDS

LuxCis® ARINC 801 Termination kits are developed according to ARINC 806 "Fiber Optic Installation and Maintenance" report.

Tools and materials included are RoHS compliant.



PRODUCT RANGE OVERVIEW

Radiall offers Termination kits for various type of contacts or connectors.

Series	Description	Part Number
LuxCis® ARINC 801 	Termination kit with 220 Volt curing oven	F780 862 000
	Termination kit with 110 Volt curing oven	F780 861 000
	Polishing kit	F780 860 000
ABS1379/EN4531 	Termination kit with 220 Volt curing oven	F780 854 003
	Termination kit with 110 Volt curing oven	F780 854 002
LC connector 	Termination kit with 220 Volt curing oven	F780 850 000
SC/FC/ST connectors 	Termination kit with 220 Volt curing oven	F780 844 000

Termination kits and tools for other connectors and contacts (MT ferrule and MT based connectors, Expanded Beam contacts and connectors, etc.) can be provided, don't hesitate to contact your Radiall representative

Termination

LUXCIS® ARINC 801 TERMINATION KITS

















Termination is a sensitive process. If not done carefully and following Radiall's instructions, your terminated connector or contact will not achieve its full potential in terms of mechanical and optical performance.

The LuxCis® ARINC 801 termination kits include all the required tools and material for an optimal termination of LuxCis® ARINC 801 contacts. They have been developed according to ARINC 806 "Fiber Optic Installation and Maintenance" report.

2 versions:

F780 862 000: termination kit with 220 Volts curing oven
 F780 861 000: termination kit with 110 Volts curing oven

KITS CONTENT:

Part Number	Description	Picture
282 515	Plastic insertion/extraction tools, size 16 (MIL-PRF-81969/14-03)	
F718 176 104	Bag of 10 protective dust caps for LuxCis® ARINC 801 contact	
F780 025 000	Primary stripper (for 900 µm buffer)	
F780 033 000	Wire stripper	
F780 034 000	Cutting pliers	
F780 057 000	Crimping tool (print 3.4 mm)	
F780 132 000	Resin applicator	
F780 136 000	Ceramic scoring blade	
F780 242 010	353ND epoxy resin pack: bags of resin & containers	
In F780 862 000: F780 495 100 (220V)	Curing unit: Including the curing oven, the curing block and the thermometer	
In F780 861 000: F780 496 100 (110V)		
F780 880 000	Cure adapters	
F780 503 000	Resin injector	
F780 504 000	Pack for resin injector (capillaries)	
F780 508 000	Bag of 10 abrasive strips 12 µm	
F780 902 000	Fiber optic cleaning platform with wipes and pad	
503 08 770	Printed and illustrated procedure	

Other items included in the kit: Ruler, solvent dispenser, waste container, moss cable support, markers, safety goggles, adhesive tape and tweezers. All part numbers can be ordered separately.

Termination



LUXCIS® ARINC 801 POLISHING KITS

Polishing has a determining role in connectors' installation. With the Polishing kit, Radiall provides a field friendly solution which produces quality polished connectors with high levels of consistency from batch to batch. It is adapted for use in the field or in assembly shops with low volume.

LuxCis® ARINC 801 Polishing Kit: F780 860 000

The kit comes in a sturdy case with foam protective padding and includes a complete set of tools and supplies to polish or repolish LuxCis® ARINC 801 contacts. A complete and thorough procedure is also included to lead users through the steps.

KIT CONTENT:

Part Number	Description
F780 893 000	Polishing machine
F780 649 000	PC polishing jig
F780 648 000	APC polishing jig
F780 893 001	Polishing pad (black 90)
F780 887 000	Bag of 50 polishing 3 µm films Diameter: 60 mm
F780 888 000	Bag of 50 polishing 1 µm films Diameter: 60 mm
F780 886 000	Bag of 50 lapping final polishing films. Diameter: 60 mm
Supplies	Cleaning tissues
Supplies	Hexagonal key
282 515	Plastic insertion and extraction tools, size 16 (MILPRF-81969/14-03)
F780 809 000	Solvent dispenser
F718 176 104	Bag of 10 protective caps for LuxCis® ARINC 801
503 08 770	Printed procedure



RANGE EXTENSION:

Radiall can also provide:

- Protrusion gauges (for repolishing control)
- Polishing solution for high volume assembly
- Test and measurement equipment: interferometry, visual inspection, losses measurement, etc.
- Polishing tools for other contacts and connectors: ABS1379 EN4531, 29504 type termini, LC, etc.

For any further information, please contact your local Radiall representative.

Termination

LC TERMINATION KIT: F780 850 000

The kit contains all the required tools to assemble and manually polish LC connectors.

KIT CONTENT:

Part Number	Description
F780 483 000	Curing oven (220V)
F780 633 000	Manual polishing tool (PC straight polishing)
F780 057 000	Crimping tool (print 3.4 mm)
F780 290 000	Inner sleeve insertion tool
F780 033 000	Wire stripper
F780 025 000	Primary stripper (for 900 µm coating)
F780 812 000	Soft rubber polishing base
F780 136 000	Ceramic scoring blade
F780 652 000	Handheld microscope (magnification x 100)
F780 039 000	Ceramic scissors
F780 809 000	Solvent dispenser
F780 527 000	Set of cleaning paper
F780 811 000	Waste container
F780 827 000	Bag of 10 polishing 0.3 µm films
F780 826 000	Bag of 10 polishing 1 µm films
F780 825 000	Bag of 10 polishing 3 µm films
F780 508 000	Bag of 10 abrasive strips 12 µm
F780 242 010	353ND epoxy resin pack: bags of resin & containers
F780 217 000	Bag of 5 syringes

Other items included in the kit: Ruler, tweezers, adhesive paper, cable/fiber preparation template, thermometer.

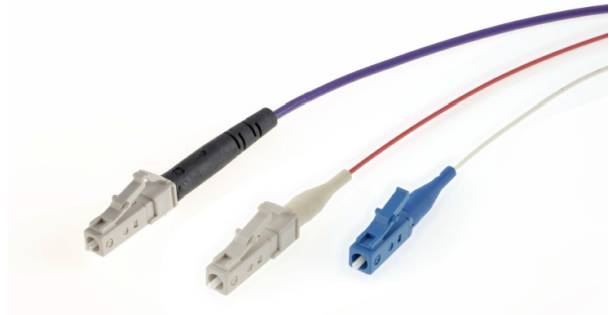

Termination

SC, FC AND ST TERMINATION KIT: F780 844 000

The kit contains everything you need to assemble and polish SC, FC or ST connectors.

KIT CONTENT:





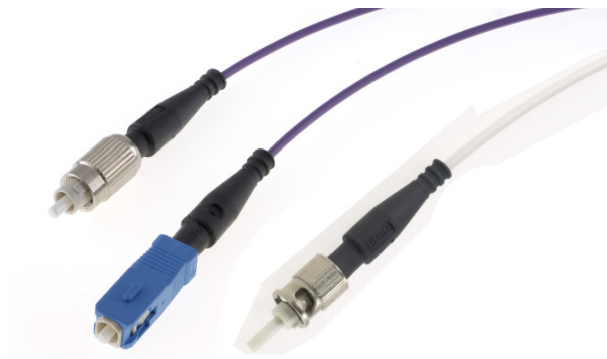



Part Number	Description
F780 463 000	Curing oven (220V)
F780 033 000	Wire stripper
F780 025 000	Primary stripper (for 900 µm coating)
F780 812 000	Soft rubber polishing base
F780 136 000	Ceramic scoring blade
F780 233 000	Handheld microscope (magnification x 100)
F780 039 000	Ceramic scissors
F780 809 000	Solvent dispenser
F780 811 000	Waste container
F780 527 000	Set of cleaning papers
F780 584 000	Set of 50 cleaning tips
F780 827 000	Bag of 10 polishing 0.3 µm films
F780 826 000	Bag of 10 polishing 1 µm films
F780 825 000	Bag of 10 polishing 3 µm films
F780 508 000	Bag of 10 abrasive strips 12 µm
F780 318 000	Bottle of abrasive solution
F780 242 010	353ND epoxy resin pack: bags of resin & containers
F780 243 000	Bag of 5 syringes for ST connectors
F780 219 000	Bag of 5 syringes for FC/SC connectors

Other items included in the kit: Ruler, tweezers, adhesive paper, cable/fiber preparation template, thermometer.



Termination

MISCELLANEOUS TOOLS

Series	Part Number	Description	Packaging	Picture
SC/FC	F780 219 000	Syringes (pink)	5	
ST/ABS1379	F780 243 000	Syringes (green)		
LC	F780 217 000	Syringes (pink)		
LuxCis® ARINC 801	F780 503 000	Resin injector	1	
	F780 504 000	Pack for resin injector (capillaries)	100	
SC/FC	F780 581 000	Needles	10	
All series	F780 034 000	Cutting pliers	1	
	F780 136 000	Ceramic scoring blade		
	F780 809 000	Solvent dispenser		
SC/FC/ST	F780 051 000	Crimping tool		

Termination supplies and tools for other connectors and contacts (MT ferrule based connectors, Expanded Beam contacts and connectors, etc.) can be provided, don't hesitate to contact your Radiall representative.

Master Cords

INTRODUCTION

Radiall offers a broad range of high performance Master Cords (Quality Measurement Jumpers) which are manufactured and tested using the latest measurement processes and standards.

Offering the lowest Insertion Loss and the highest Return Loss, Radiall Master Cords are used to measure optical properties of optical devices.

Radiall's Master Cords are terminated with our high quality reference connectors in order to ensure the most accurate and repeatable IL and RL measurements of assemblies and connections.

FEATURES AND BENEFITS

- All Master Cords are optically tested with 100% interferometry and eccentricity measurements
- Master terminations available in UPC and APC
- Wide variety of connectors and contacts
- Easy identification due to a red boot on the master connector or a printed yellow shrink sleeve on the master contact
- Standard length: from 2 to 5 meters (other lengths available upon request)
- Using high quality Zirconia ceramic ferrule

All Master Cords are delivered with a measurement sheet and product traceability information.

INTERNATIONAL STANDARD DOCUMENTS COMPLIANCE

TIA/EIA-455-171A - Annex A (2.5 mm dia ferrule)

CEI 60874-14-1 & CEI 61754-4 (2.5 mm dia ferrule) ARINC 805 (1.25 mm dia ferrule)

TELECORDIA GR326 CORE (2.5 mm dia ferrule)

END FACE GEOMETRY

- Eccentricity between fiber core and ceramic outer diameter: 0.3 μm
- Eccentricity of spherical polished end face (apex offset): <30 μm (IEC 61300, 2-40)

OPTICAL PERFORMANCE

- Insertion Loss: <0.15 dB (IEC 61300, 3-4 Method B-mated with reference plug)
- Return Loss: >50 dB for UPC and >60 dB for APC

MECHANICAL AND ENVIRONMENTAL CHARACTERISTICS

Connector or contact dependent. Please refer to the relative section of this catalog.

Please contact Radiall Sales team with your specific requirements for any other configuration.

For more information on measurement methods and end face geometry, refer to section 12, technical information.

Master Cords

LUXCIS® ARINC 801 MASTER CORDS



Patchcords (2 meters length)

Master Termination			Standard Termination			Part Number
LuxCis® ARINC 801	MM		FC	MM		F792 393 800
LuxCis® ARINC 801	SM	UPC	FC	SM	UPC	F792 390 800

LC MASTER CORDS



Patchcords (5 meters length)

Master Termination			Standard Termination			Part Number
LC	SM	UPC	FC	SM	APC 8° "R"	F792 530 801
LC	SM	UPC	FC	SM	UPC	F792 510 800

Note: FC APC 8° "R": 2 mm key

Pigtails (5 meters length)

Master Termination			Part Number
LC	SM	UPC	F792 500 800

Master Cords

SC MASTER CORDS

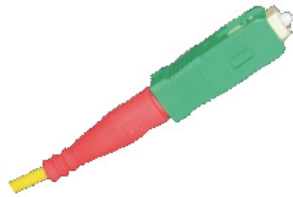

Patchcords (5 meters length)

Master Termination			Standard Termination			Part Number
SC	SM	UPC	FC	SM	UPC	F792 130 800
SC	SM	UPC	FC	SM	APC 8° "R"	F792 130 801
SC	SM	UPC	SC	SM	UPC	F792 110 800
SC	SM	APC 8°	SC	SM	UPC	F792 111 800
SC	SM	APC 8°	SC	SM	APC 8°	F792 111 801
SC	SM	APC 8°	FC	SM	UPC	F792 131 800
SC	SM	APC 8°	FC	SM	APC 8° "R"	F792 131 801

Note: FC APC 8° "R": 2 mm key and FC UPC: 2.14 mm key

Pigtails (5 meters length)

Master Termination			Part Number
SC	SM	UPC	F792 100 800
SC	SM	APC 8°	F792 101 800

ABS1379 EN4531 MASTER CORDS



Patchcords (2 meters length)

Master Termination	Standard Termination			Part Number
ABS1379 EN4531 MM PC	FC	MM	PC	F792 378 800

Notes

Section 12



**Technical Information and
Glossary of Terms**



Contents

Fiber Optics Basics

What Is An Optical Fiber?	12-2
Light Propagation	12-2
Refractive Index	12-3
Dispersion	12-3
Main Fiber Types	12-4 to 12-5
Typical Transmission Properties of Glass Fibers	12-6

Cables

Typical Indoor Cables	12-7 to 12-8
Typical Outdoor or Aerospace Cables	12-9
Color Coding	12-10

Connections

Interface Technologies	12-10 to 12-12
Locking Mechanisms	12-13
Panel Mount Mechanisms	12-13

Processes and Radiall's Technologies

General Guidelines For Fiber Optic Handling	12-14 to 12-15
The Importance Of Cleaning	12-15
Cleaning Process	12-16
Termination Process	12-17 to 12-19
Polishing Process	12-20 to 12-21
Visual Inspection	12-22
End Face Geometry and Interferometry	12-23
Insertion Loss (IL) and Return Loss (RL) Measurements	12-24 to 12-25

Optical Active Devices

Transmitter, Receiver and Transceiver.....	12-26
Optical Extinction Ratio (ER) and Optical Modulation Amplitude (OMA).....	12-26
Optical Sensitivity.....	12-27

Glossary of Terms.....	12-28 to 12-30
------------------------	----------------

Fiber Optics Basics

WHAT IS AN OPTICAL FIBER?

Optical fiber is a “light pipe” carrying pulses of light generated by lasers, or other optical sources, to a receiving sensor. Usually manufactured from high purity silica glass-like rods drawn into fine hair-like strands and covered with a thin protective plastic coating, an optical fiber consists of four concentric layers:

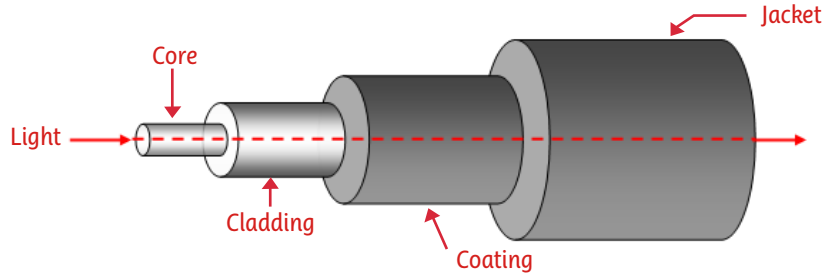

- A core in which the light propagates
- A cladding that confines light in the core
- A coating or plastic buffer that acts as protection and allows the glass rod to be curved
- A jacket which provides outer mechanical and environmental protection

Then, fibers are subsequently packaged in various cable configurations (jacket) before installation in the external or internal networks.

LIGHT PROPAGATION

Light pulses are launched into the core region. The surrounding cladding layer keeps the light traveling down the core and prevents light from leaking out.

This phenomenon is called: Total Internal Reflection.

When light crosses a boundary between two mediums with different refractive indexes, the light beam is partially refracted and partially reflected. This depends on the incidence angle and the refractive indexes of each medium. If light comes from a more optical dense medium and with an angle bigger than the “critical angle”, then all the light is reflected.

Example: The reflection of the light on a glass surface

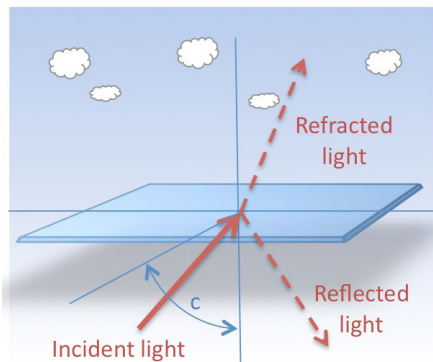

Light is partially reflected and partially refracted because its angle of incidence is inferior to the critical angle.

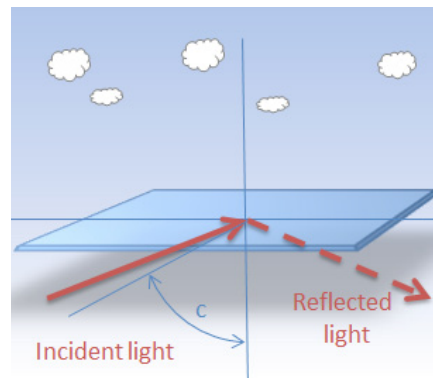

Light is totally reflected because its angle of incidence is superior to the critical angle.

Fiber Optics Basics

In an optical fiber, the light travels through the core (n_1 , high index of refraction) by constantly reflecting from the cladding (n_2 , lower index of refraction) because the angle of the light is always greater than the critical angle.

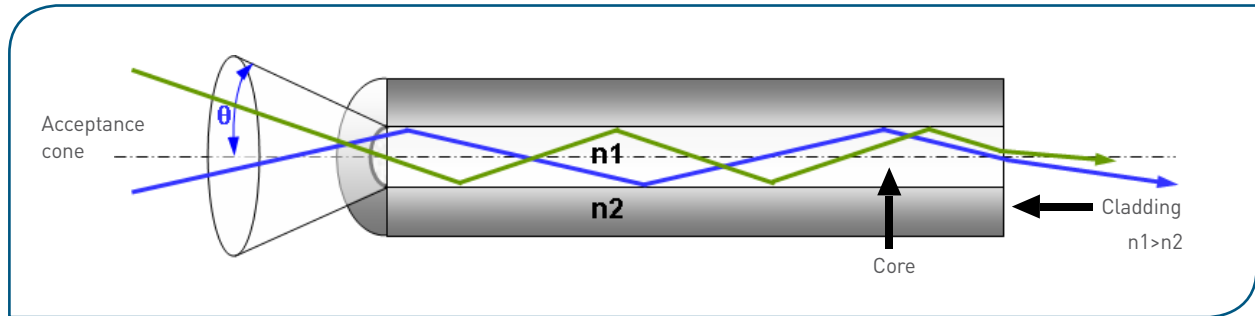

The light rays are totally reflected by the cylindrical surface between the core and the cladding because of their different refractive indexes. To confine the light (the optical signal) into the core, the refractive index of the cladding must be lower than that of the core: $n_1 > n_2$.

There is a maximum angle from the fiber axis at which light may enter the fiber so that it will propagate in the core of the fiber. The sine of this maximum angle is the **numerical aperture (NA)** of the fiber. Fiber with a larger NA requires less precision to splice and work with than fiber with a smaller NA.

REFRACTIVE INDEX

The refractive index (n) describes the way light travels into a substance. It is expressed as a ratio of the speed of light in a vacuum relative to that in the considered substance.

$$n = \text{velocity of light in a vacuum} / \text{velocity of light in medium}$$

For instance, the refractive index of water is 1.33, meaning that light travels 1.33 times as fast in a vacuum as it does in water.

Typical refractive index:

- refractive index of vacuum: $n = 1$ (reference/minimum value that cannot be improved)
- refractive index of air: $n = 1.0003$ (value very close to the vacuum)
- refractive index of glass: $n \approx 1.5$

DISPERSION

This is the main cause of bandwidth limitations in a fiber. Dispersion causes a broadening of input pulses along the length of the fiber.

Three major types are:

- **modal dispersion** caused by differential optical path lengths in a MultiMode fiber
- **material dispersion** caused by a differential delay of various wavelengths of light in a waveguide material
- **waveguide dispersion** caused by light traveling in both the core and cladding materials in SingleMode fibers

As a result of the dispersion, the light pulses spread out over time and thereby restrict the bit rate and/or the length of the efficient optical link.

Fiber Optics Basics

MAIN FIBER TYPES

There are two types of optical fibers:

- MultiMode (MM) fibers where the fiber core can receive several propagation modes. Two technologies exist for MultiMode fibers: step index and graded index fibers.
- SingleMode (SM) fibers with only one propagation mode

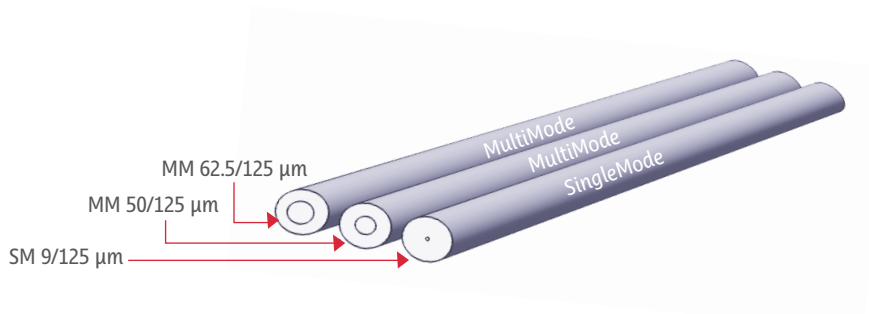

Step-index MultiMode Fiber

In a step-index MultiMode fiber, many rays of light are guided along the fiber core by total internal reflection. Rays that meet the core-cladding boundary at a high angle, bigger than the critical angle, are completely reflected. The critical angle is determined by the difference in refractive index between the core and cladding materials. Rays that meet the boundary at a low angle are refracted from the core into the cladding and do not convey light along the fiber.

The critical angle determines the acceptance angle of the fiber, often reported as the Numerical Aperture. A high numerical aperture allows light to propagate down the fiber in rays both close to the axis and at various angles, allowing efficient coupling of light into the fiber. However, this high numerical aperture increases the amount of dispersion as rays, at different angles, have different path lengths and therefore take different times to transit through the fiber.

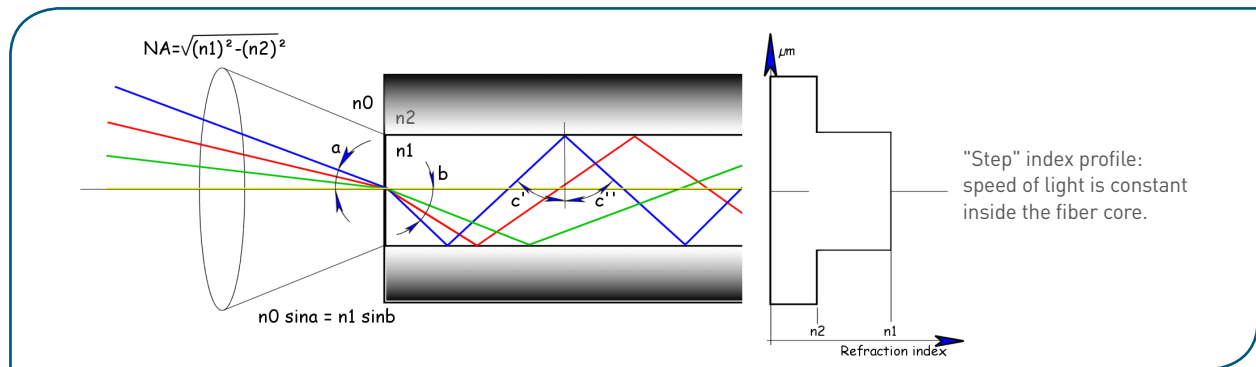

In short:

- Different light pathways (modes)
- Light rays arrive separately at the receiving point
- Space between pulses to prevent overlapping limits bandwidth
- Best suited for transmission over short distance
- High numerical aperture adapted to wide optical source (LED)

Fiber Optics Basics

Graded Index MultiMode Fiber

A graded index MultiMode fiber contains a core in which the refractive index decreases gradually from the center axis to the cladding. The high refractive index at the center makes the light rays close to the cladding progress faster than those near the axis. Because of the graded index, light in the core curves helically, reducing its travel distance. A shortened path and a higher speed allow the light rays to arrive at the receiver almost at the same time providing less dispersion.

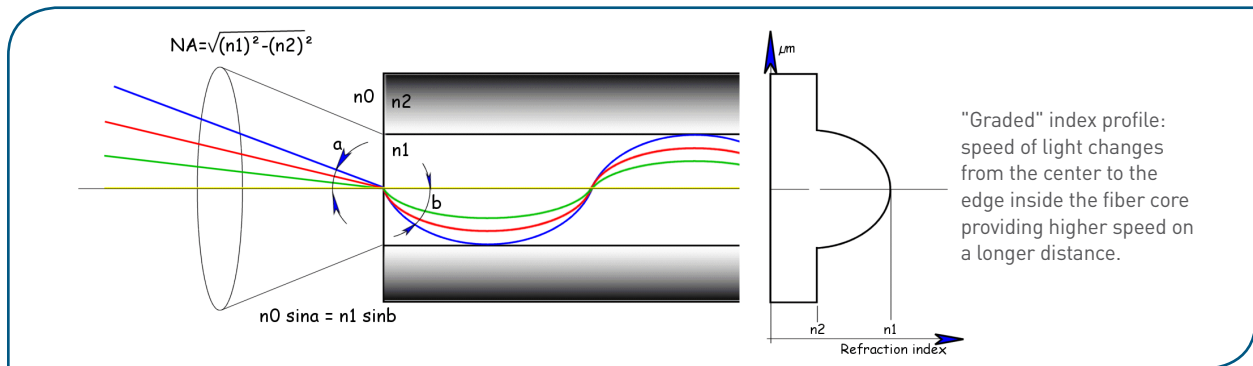

In short:

- Different light pathways (modes)
- No delay at the receiving point
- Best suited for transmission over medium to long distance
- High numerical aperture adapted to wide optical source (LED)

SingleMode Fiber

SingleMode fiber only supports one light ray (one mode of light propagation) because of the reduced dimension of the core. The core diameter is $9 \mu\text{m}$ for a SingleMode propagation of wavelength from 1300 nm to 1550 nm . This propagation mode provides higher transmission rate and no modal dispersion.

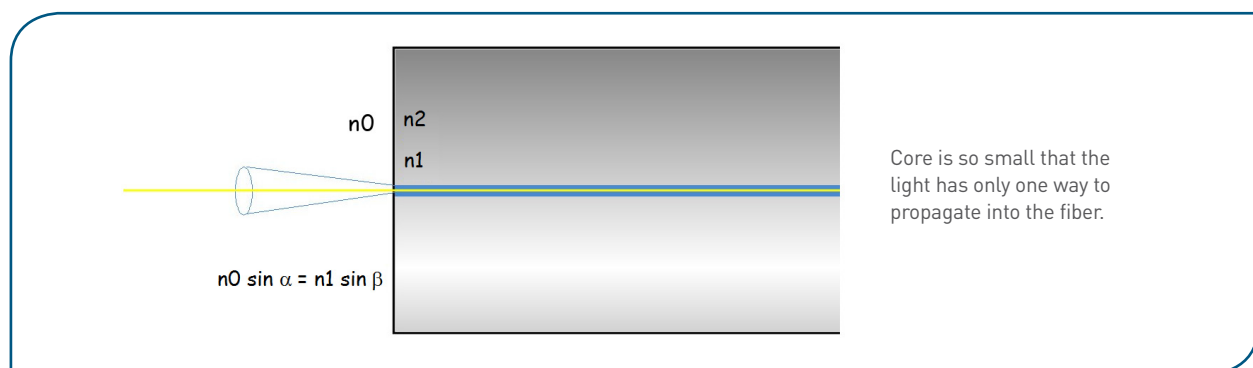

In short:

- One light pathway (mode) parallel to the axis
- Very limited pulse dispersion
- Adapted for long distance transmission
- Very widely used, not expensive for telecom
- Small numerical aperture adapted to high coherence optical source (Laser)

Fiber Optics Basics

TYPICAL TRANSMISSION PROPERTIES OF GLASS FIBERS

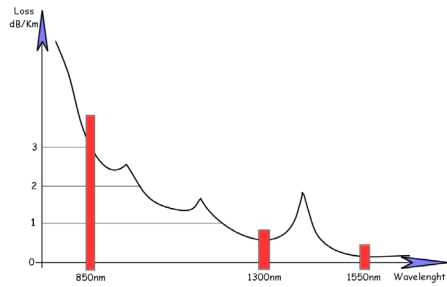

For telecommunication and for glass optical fibers, we use light in the infrared region, typically around 850, 1300 and 1550 nm due to low attenuation of the glass fiber at those wavelengths.

Glass fibers are the most common fibers used for telecommunication applications.

The ISO/IEC11801 specification describes the data rate and reach of optical fiber grades referred to as: OS1, OS2, OM1, OM2, OM3 and OM4 (the MultiMode fibers are prefixed with “OM” and the SingleMode fibers “OS”).

Performances of existing fibers compliant to relevant standards:

Optical Fiber Type	Core Diameter μm	Maximum Attenuation dB/km		Minimum Modal Bandwidth MHz x km		
		850 nm	1300 nm	Overfilled Launch Bandwidth (LED source)		Effective Laser Launch Bandwidth
				850 nm	1300 nm	850 nm
OM1	62.5	3.5	1.5	200	500	-
OM2	50	3.5	1.5	500	500	-
OM3	50	3.5	1.5	1500	500	2000
OM4	50	2.5	0.8	3500	500	4700

Optical Fiber Type	Core Diameter μm	Maximum Attenuation dB/km	
		Overfilled Launch Bandwidth (LED source)	Effective Laser Launch Bandwidth
		1310 nm	1550 nm
OS1	9	0.4	0.25
OS2	9	0.4	0.25

Distance capability of the fibers according to the relevant Gigabit Ethernet standards:

	1000BASE-SX 1 Gbit/s	10GBASE-S 10 Gbit/s	40GBASE-SR4 40 Gbit/s	100GBASE-SR10 100 Gbit/s
OM1	275 m	33 m	-	-
OM2	550 m	82 m	-	-
OM3	-	300 m	100 m	100 m
OM4	-	550 m	150 m	150 m
OS2	-	-	10 km	10 km

Fiber Optics Basics

Transmission losses caused by bend: Optical fiber is sensitive to stress, particularly bending which leads to some light losses. The smaller the bending radius is, the greater the losses are. Some fibers, like the G657 SingleMode fiber are optimized to be insensitive to bends. The minimum bending radius will vary according to cable designs. The manufacturer specifies the minimum radius to which the cable may safely be bent during installation and over the long term. If no minimum bend radius is specified, one can safely assume a minimum long-term low-stress radius not less than 10 times overall diameter for MultiMode cables, and 20 times overall diameter for SingleMode cables.

Beside mechanical destruction, another reason why one should avoid excessive bending of fiber-optic cables is to minimize microbending and macrobending losses. Microbending causes light attenuation induced by deformation of the fiber while macrobending causes the leakage of light through the fiber cladding and this is more likely to happen where the fiber is excessively bent.

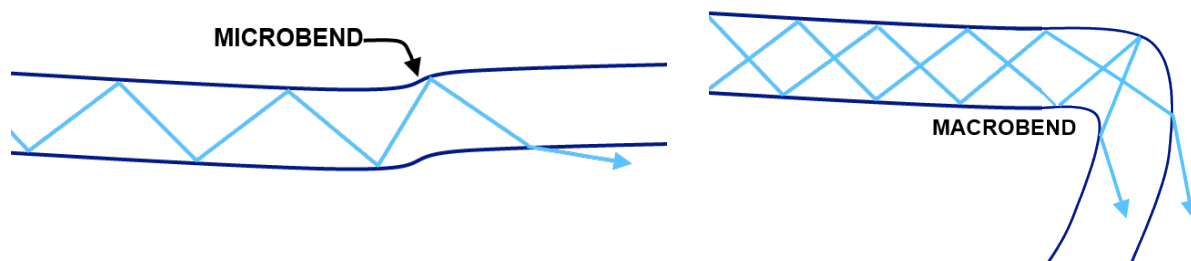

Cables

In order to cope with any stress (tensile, bending, torsion, etc.) or environmental conditions (weather, abrasion, chemical, thermal, etc.), fiber optics need to be protected by a suitable cable structure.

TYPICAL INDOOR CABLES

For inside buildings, houses and equipment. Typical temperature range: -20°C/+70°C.

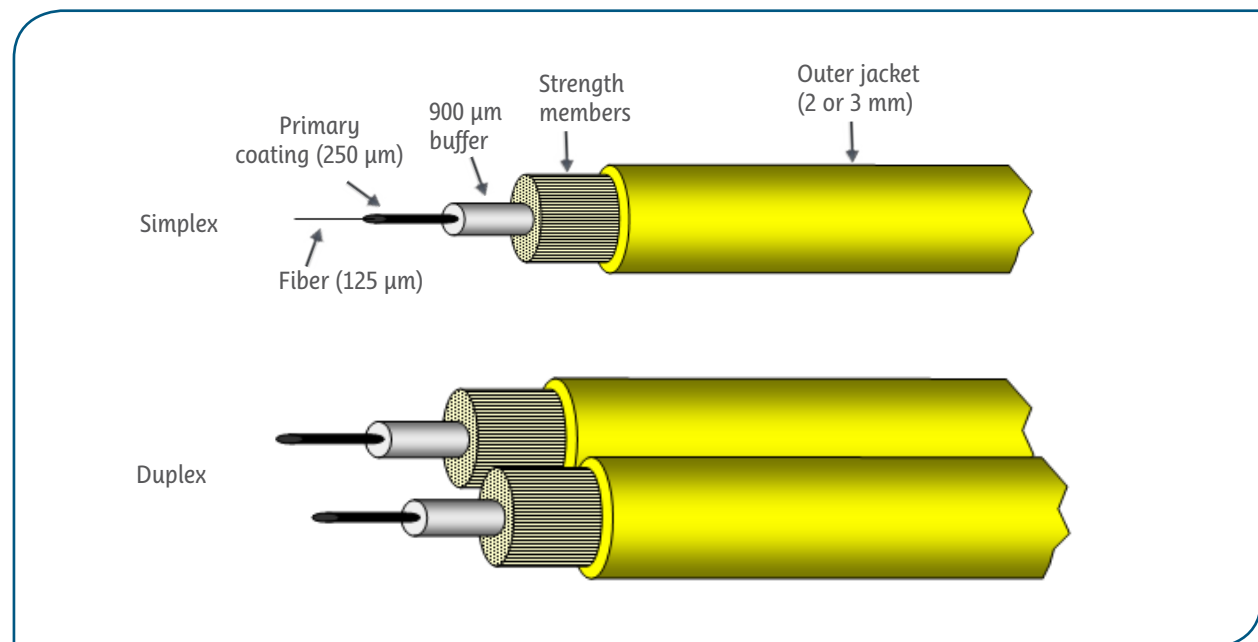

Cables

For indoor cables, there are two basic designs of cable structures: loose and tight. Both contain some strength members, such as aramid yarn or glass fibers.

Loose Structure Cables:

- The optical fiber (250 µm) is inside a plastic protective tube that allows limited movements of the fiber
- Usually contains a water resistant gel surrounding the fiber
- Usually dedicated to pigtails

Tight Structure Cables:

- The fiber is strictly immobilized inside the jacket. This structure allows no movement of the buffered fiber with respect to the outer jacket and strength members
- Good behavior with temperature changes
- More robust than loose-tube cables, they are best suited for moderate length LAN or WAN connections, long indoor runs, direct burial and for underwater use.

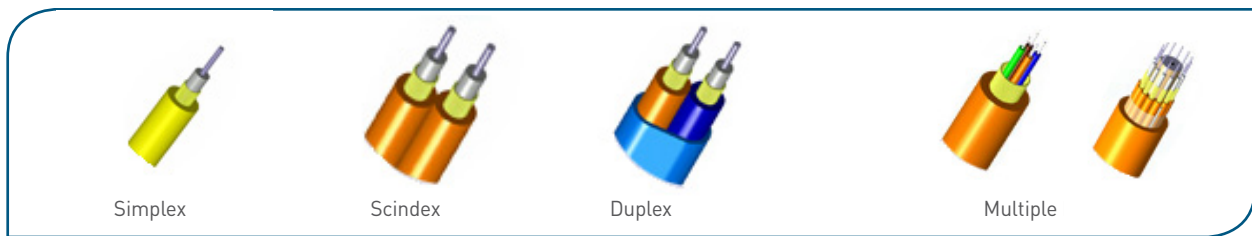

Other types of fibers and cable configurations exist, such as ribbon or POF (Plastic Optical Fiber).

Indoor Fiber Optic Cable Fire Prevention:

For European markets, communication cables must typically comply with IEC 60332-3 (EN 50266) or IEC 60332-1 (UL VW1) fire tests depending on the application. In most of the countries LSZH (Low Smoke Zero Halogen) materials are mandatory. LSZH cable jackets are composed of fire retardant materials that reduce the amount of smoke emitted when combusted. LSZH cables contain zero halogen during combustion. They have been cited as an ideal cable jacket in high risk areas of fire or crowded public locations.

For the US market, communication cables must comply with the National Electrical Code (NEC) requirements. There are three types of indoor spaces identified by NEC: plenums, risers and general purpose areas.

- What is a plenum area and plenum rated fiber optic cable?

Plenum is an air-handling, air flowing and air distribution system space such as that found above drop ceiling tiles or heating and ventilation ducts. Plenum rated cables must meet UL-910 specification and their outer jackets are made of materials that retard the spread of flame, produce little smoke and protect electronic equipment from damage in fires.

- What is a riser area and riser rated fiber optic cable?

Riser is a pathway such as floor opening, shaft or duct that runs vertically through floors. Riser rated cables can be run through building vertical shafts (risers) or from one floor to another floor. Riser rated cables must meet UL-1666 fire resistance specification and cannot be installed in plenum area. However plenum rated cables can be used as a substitute for it and installed in riser spaces.

- What is a general purpose area?

Any space on the same floor which is not plenum or rise is identified as general purpose area.

Based on NEC code, indoor fiber optic cables can be categorized under six types:

Figure	Description	Cable Application	UL Test	Possible Substitute
OFNP	Optical Fiber Nonconductive Plenum Cable	Plenum, overhead, fiber only	UL - 910	
OFCP	Optical Fiber Conductive Plenum Cable	Plenum, overhead, hybrid (fiber/wire)	UL - 910	
OFNR	Optical Fiber Nonconductive Rise Cable	Riser, backbone, fiber only	UL - 1666	OFNP
OFCR	Optical Fiber Conductive Rise Cable	Riser, backbone, hybrid	UL - 1666	OFCP
OFN	Optical Fiber Nonconductive	General purpose, horizontal, fiber only	UL - 1581	OFNP, OFNR
OFC	Optical Fiber Conductive	General purpose, horizontal, hybrid	UL - 1581	OFCP, OFCR

Cables

TYPICAL OUTDOOR OR AEROSPACE CABLES

Cable structure definition per ARINC 802:

- **Loose structure:** a fiber optic cable structure that allows limited movement of the buffered fiber (usually the 900 µm) with respect to the outer jacket and strength member.
- **Tight structure:** a fiber optic cable structure that allows no movement of the buffered fiber with respect to the outer jacket and strength member.

For communication uses:

- **Distribution fiber cables:** This compact building cable consists of 900 individual micron buffered fibers. Connectors mounting the fibers' ends are generally re-tubed with a 2 mm buffer.
- **Breakout fiber cables:** Breakout cables are also called fanout cables. In tight buffered cables each fiber is only a 900 µm tight buffered fiber, but in breakout cables every fiber is a subcable by itself. Each fiber has a 2~3 mm jacket, then an outer jacket covers these subcables, aramid yarn and ripcord inside. This design allows users to divide the cable to serve users with individual fibers, without the need for a patch panel. Breakout cables enable the quick installation of connectors onto 2+ mm robust jacketed fiber.
- **For aerospace applications,** fiber optic cables are ruggedized to withstand harsher environment conditions, such as temperature range and abrasion resistance. Flammability and toxicity are also major requirements.

Ruggedization enables glass fiber cables to withstand harsher tests:

- Thermal
- Fluid resistance
- Abrasion resistance
- Impact resistance
- Clamping
- Cable crush

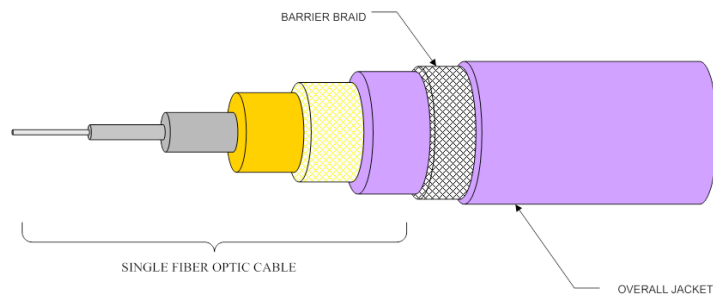

COLOR CODING

The buffer or jacket of fiber optic cables is often color-coded to indicate the type of fiber used:

Fiber & Cable Type	Color Code
MultiMode fiber [50/125] (TIA-492AAAB) [OM2]	Orange
MultiMode fiber [50/125] (TIA-492AAAC) [OM3, OM4]	Aqua
MultiMode fiber [62.5/125] (TIA-492AAAA) [OM1]	Orange
MultiMode fiber [100/140]	Orange
SingleMode fiber (TIA-492C000 / TIA-492E000) [OS1, OS2]	Yellow
Aerospace cables	Purple
Polarization Maintaining SingleMode	Blue

Outdoor patchcords are usually black.

Connections

According to Telcordia Generic Requirements for optical connectors and jumper assemblies, optical fiber connectors are used to join optical fibers where a connect/disconnect capability is required.

INTERFACE TECHNOLOGIES

There are several alignment technologies to connect the cores of fibers so that light can pass:

- Physical Contact: Fibers are core to core mechanically contacted
- Expanded beam: Beams are shaped by lenses; no contact

The various interfaces allow different performances and can be optimized to minimize the losses. In case of an interface issue several connection losses can occur.

CONNECTION LOSSES

Optical losses depend on the quality of the optical interface and the accuracy of the alignment between the two ferrules.

- Fresnel loss: The Fresnel loss can be the result of multiple causes: pollution, bad polishing quality, installation and any manipulation that can alter the end face connector or contact

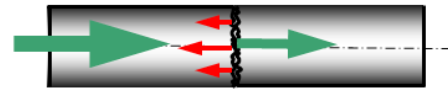

- Loss by lateral misalignment

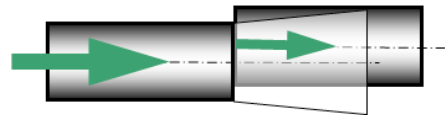

- Loss by angular misalignment

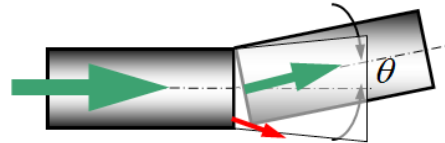

- Loss by axial separation (unseated contact)

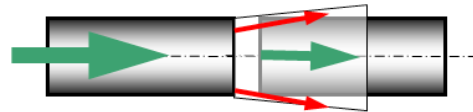

Connections

PHYSICAL CONTACT (PC) TECHNOLOGY

In PC technology, a connector assembly consists of an adapter and two connector plugs. Fibers are core to core mechanically contacted.

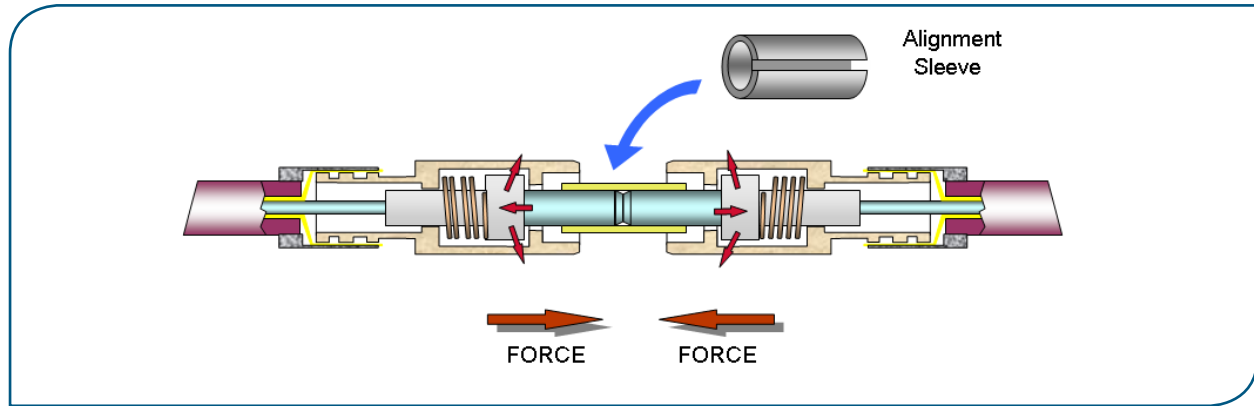

The ferrules of the plugs are aligned into a guiding sleeve belonging to the adapter.

PC and UPC Polishing

Available for all types of fibers, SingleMode or MultiMode, the PC (Physical Contact) is a curved polishing, centered on the optical axis.

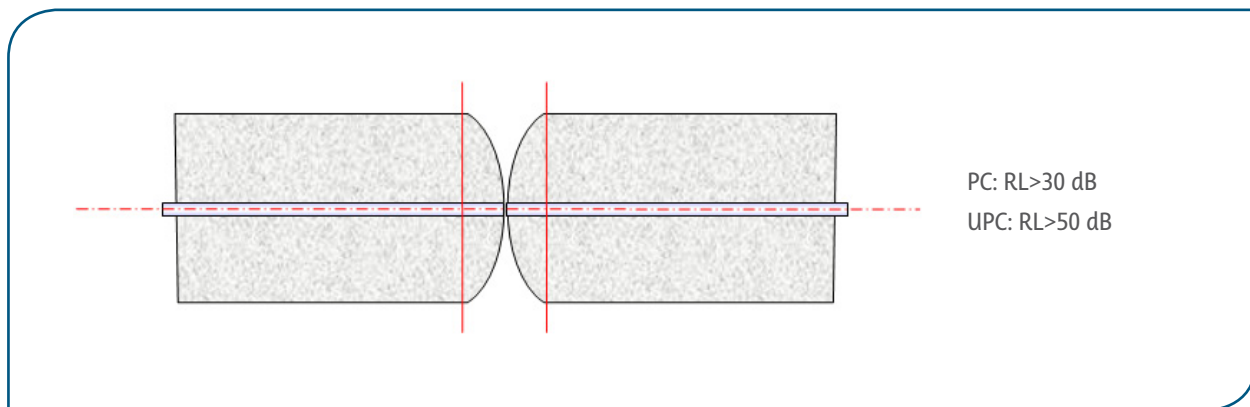

The UPC (Ultra Physical Contact) polishing may be required for SingleMode fibers. The geometry is the same as PC and leads to the same level of Insertion Losses but the quality of polishing is higher and provides Return Losses of 50 dB (compared to 30 dB in PC).

Connections

APC Polishing

APC (Angled Physical Contact) is a tilted curved polishing required for SingleMode fibers.

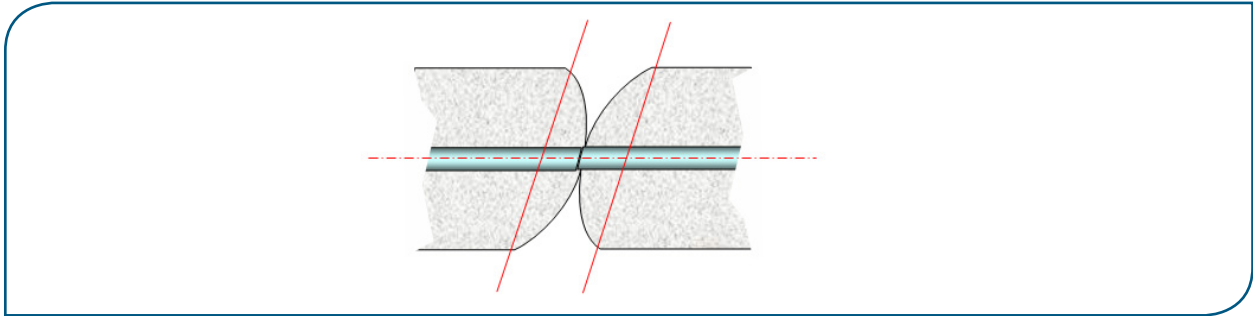

APC achieves excellent Return Losses (>65 dB), useful to avoid optical feedback in laser sources used in analog-over-fiber or fiber sensing applications. For standard SingleMode fiber, the 8° polish angle is chosen to ensure the modest magnitude of light that is otherwise reflected at the end face of a suitably polished terminus, is reflected at an angle greater than the maximum guide angle of the waveguide and is lost to the cladding and surrounding buffer layer.

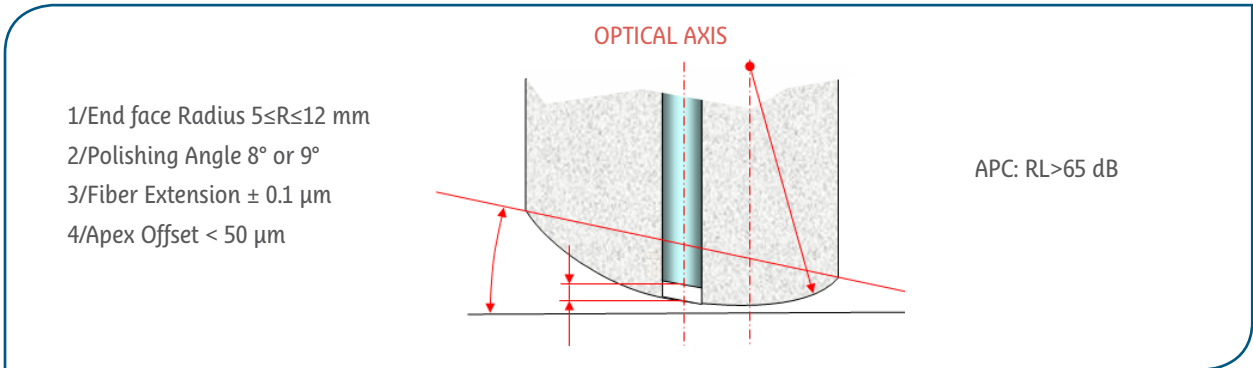

EXPANDED BEAM TECHNOLOGY (EB)

In EB technology, light is expanded at the output of the fiber due to a ball lens, collimated and transmitted across an air gap. By using a symmetric system for the opposite plug, the light can be refocused back down to the core of the receiving fiber.

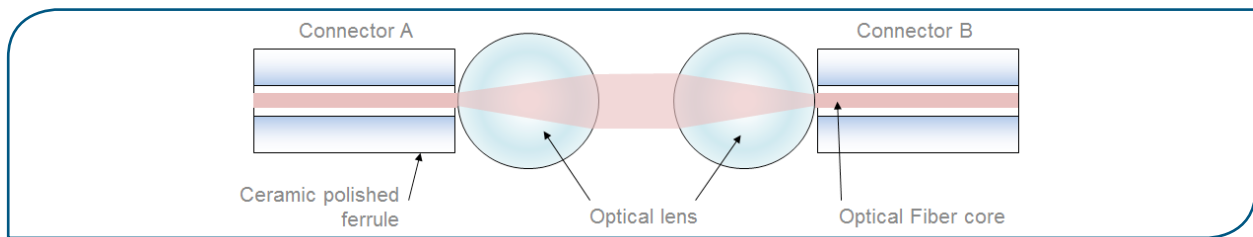

Most of the time, no adapter is required for this type of assembly: the plugs are able to connect to each other.

Due to the beam expansion, the optical connection is less sensitive to dust and lateral misalignment. As the optical ends are not in physical contact, there is no damage to the fiber even after repeated matings. These optical connectors allow a high number of matings. Optical losses are mainly due to air gap (Fresnel loss). They also depend on the accuracy of the positioning of the ferrule to the lens (focal distance).

Connections

LOCKING MECHANISMS

There are numerous types of plugs and sockets to connect optical fibers, using threaded, bayonet, push-pull and snap-lock connections.

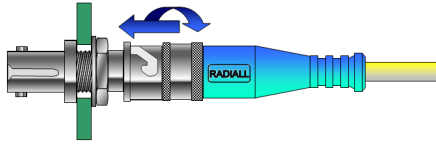

Bayonets: e.g. ST series

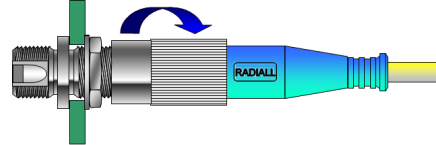

Screw-in: e.g. FC, RxF series

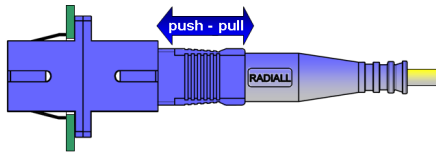

Push-pull snap-in: e.g. SC series

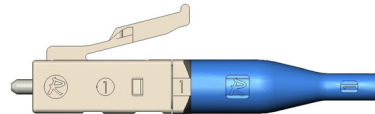

Push-pull latched: e.g. LC series

PANEL MOUNT MECHANISMS

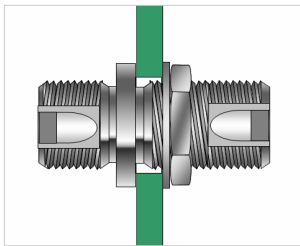

Bulkhead: screw and nut feed through technology

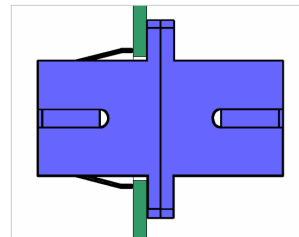

Snap-in: elastic spring technology

Processes and Radiall Technologies

GENERAL GUIDELINES FOR FIBER OPTIC HANDLING



Proper care and cleaning of fiber and connectors will improve the long-term performance and quality of services delivered by the fibers in a network and minimizes the potential for injury.

Safety Reminders:

- Always work in the cleanest possible environment, no drinks, food nor smoking can be permitted close to fiber optics.
- Wear safety glasses with side shields to protect the eyes from fiber shards and splinters.
- Never look into a fiber, or connect to a fiber micro-scope, while system laser is on.
- Do not touch your eyes or face at any time while handling bare fiber.
- Wash your hands immediately after working with bare fiber or solvents.
- Never use your hands to clean a fiber work area.
- Fiber waste is a safety hazard, dispose of cleaved pieces properly.

Storage:

- Do not expose fiber optic cables to direct sunlight.
- Follow supplier instructions for recommended storage temperature.
- When a fiber-optic cable is disconnected, install a protective cap on both the cable connector and the equipment connector.
- Unused adapters and connectors should always be covered.

Handling:

- Always read and comply with the handling instructions of your supplier.
- Check your tools and materials for wear and expiry dates.
- Do not allow kinks or knots to develop in the fiber.
- Never use the fiber to pick up or support the weight of the device to which it is attached.
- Never apply excessive force to the fiber-optic cable by pulling, bending or twisting it.
- Never allow the fiber to come into contact with sharp edges.
- Never place tools or other hard and heavy items on top of the fiber.
- The minimum bend radius of the fiber must always be maintained (Refer to the cable specification to know the limits).

Processes and Radial Technologies

USUAL DAMAGE TYPES & GOOD PRACTICES

Fatigue damage:

Fatigue damages are a slow extension of a flaw due to a combination of stress, duration and moisture or humidity.
Good practices => Always follow the recommended applied stress design guidelines from your supplier.

Abrasive damage:

Abrasive damage may occur when a fiber comes into sliding contact with a sharp object. It can cause scratched or scraped fiber coating and expose the cladding surface or even damage the glass surface of the fiber.
Good practices => Do not allow an optical fiber to come into contact with a sharp or jagged edge. All work surfaces should be smooth and free of any defects or debris. Detect potential damage with tactile senses.

Compressive damage:

Compressive damage may occur when a fiber is pinched, clamped or constrained to a point where the coating or glass layers become damaged.
Good practices => Never allow the fiber to contact an uncontrolled surface (for example, the floor). Never put tools or heavy burdens on top of a fiber. Be careful not to constrain the fiber with wire ties, tie wraps, jewelry or nails.

Particles penetration:

Particulates penetration occurs when a hard particle, such as glass or ceramic, penetrates the coating layer of the fiber.
Good practices => Always keep your work environment as clean as possible.

THE IMPORTANCE OF CLEANING

A “dirty” fiber optic end face is one of the main causes of poor fiber performance. The tolerance to dirt or contamination on the ends of the ferrules of a connector is near zero.

Typical contamination from 0 to 4 matings:

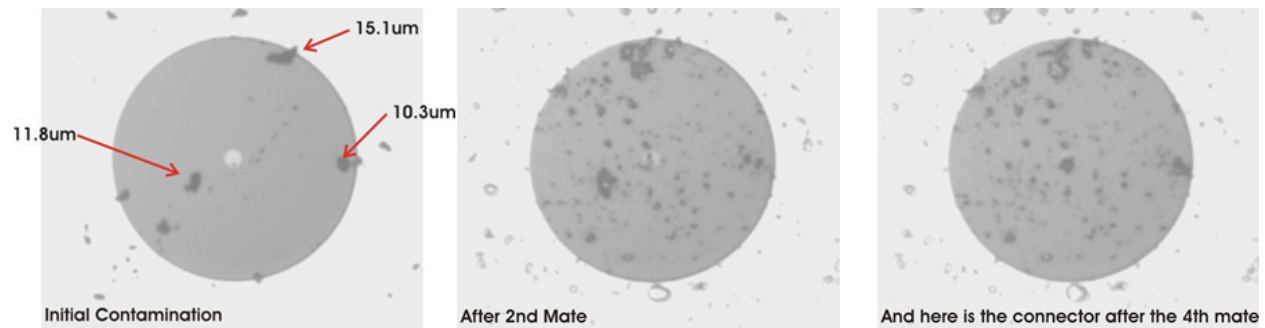

To perform cleaning and inspection processes, Radial provides high-end kits with a detailed procedure and everything you need for an optimal maintenance of your optical systems.
Refer to section 11, tool kits & accessories, for more information.

REMINDERS AND PRECAUTIONS

- The person performing the cleaning must be trained
- The area where the cleaning is to be done must be as clean as possible
- Never re-use any wipes, swabs or cleaning materials
- Cleaning material should be lint-free and smooth
- Always keep a protective cap on unplugged connectors and contacts
- Never touch an optical end face or blow on it with your mouth
- When cleaning the fiber end with lint free optic paper, apply only light pressure
- Always ensure that the solvent you use is adapted to optical fiber and is not contaminated

Processes and Radiall Technologies

CLEANING PROCESS

INSPECT

Inspect First:
With a microscope and dedicated adapter **check for contamination on the optical end faces**

Dry Technique:
If necessary **gently apply and swipe** the optical end face with a dry lint-free wipe, a swab or a mechanical stick cleaner, according to your configuration (in or out multipin connectors, type of polishing, etc.).

CLEAN

INSPECT

With a microscope and dedicated adapter **check for contamination** on the optical end faces of the contact or connector. If the connector and contact is still dirty, proceed with the **wet cleaning technique**.

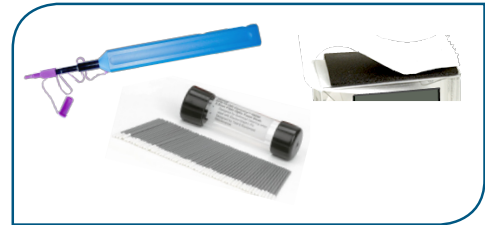

WET CLEAN

Wet Technique:
Take a swab or a wipe, dampen it lightly with a dedicated solvent and apply it gently on the terminus end face that needs cleaning.

Apply a dry swab on the end face to remove any remaining solvent.

DRY CLEAN

With a microscope and dedicated adapter **check for contamination on the optical end faces** of the contact or connector. If the connector or contact is still dirty, start over with the wet cleaning technique.

INSPECT



PLUG OR RE-CAP



Processes and Radiall Technologies

TERMINATION PROCESS

Different techniques to terminate connectors on optical fibers exist. In all cases, the connector mounting should be performed following the supplier's instructions. The following steps are the main ones that may differ upon connector type. Contact your Radiall representative to get the instructions corresponding to the product to assemble.

WORKSTATION PREPARATION

1-Preparation of the Work Station

Verify your tools according to the type of fiber, structure of cable and contact or connector you wish to terminate. Always refer to your supplier instructions and comply to the procedure provided.

Plug in and heat up the curing oven.



Never touch any part of the curing unit during and after polymerization.

Prepare a resin batch

Make sure to minimize the introduction of air bubbles



CABLE PREPARATION

2-Cable Preparation



Pay attention to the stripping dimensions and that the appropriate tools are used. Depending on the cable type, you'll need to strip through different layers until you reach the bare fiber.

Measure and mark cable to desired length.

Gently strip the different layers of the cable with the dedicated tools and the helping dimensions on the cable until you reach the bare fiber.

Remove any residual coating material from the bare fiber with a wipe dampened with solvent. A properly cleaned fiber should squeak.

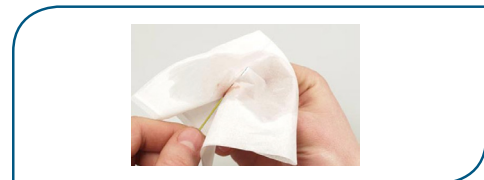
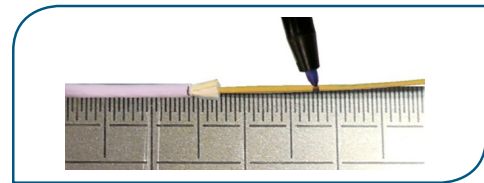

Processes and Radiall Technologies

ASSEMBLY

3-Assembly:

Inject the resin in the contact or connector you want to terminate until it appears at the ceramic tip.



Secure Bonding® (Radiall Patent)

Patented system protects the floating mechanism during the resin-injection process. A slot on the crimping body allows removing the syringe freely without the needle touching any sensitive inner surfaces. This system avoids calibrating the volume with a dispenser. The resin will be injected inside the cavity, with no risk of excess or insufficient volume, thus guaranteeing proper fiber retention. (Too much resin can break the fiber during the connection while not enough resin does not properly maintain the fiber).

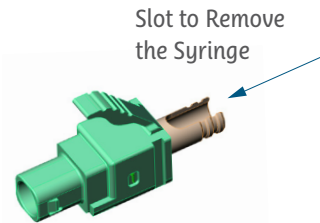
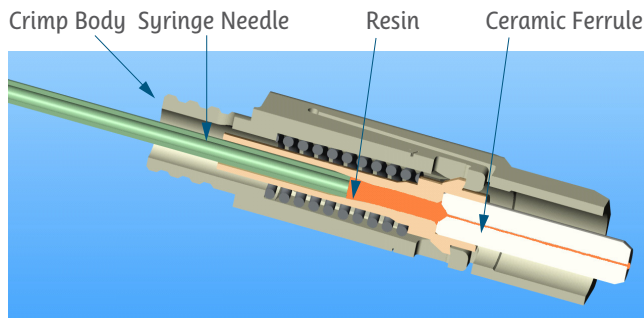

With a twisting motion and very gently, insert fiber into the terminus until it bottoms.

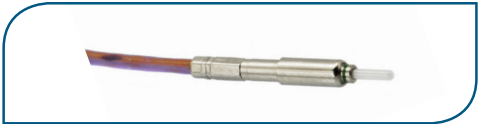

CRIMPING

4-Crimping

The crimping allows securing the fiber position inside the connector.

Crimping Reliability® (Radiall Patent)

Only one crimp operation is required for both strength members and jacket retention. A mini metallic tube (inner sleeve) is inserted between the fiber and the cable jacket to protect the fiber and avoid any stress. The shape of the crimping ring is adapted to ensure excellent cable retention.

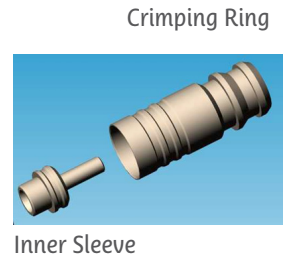
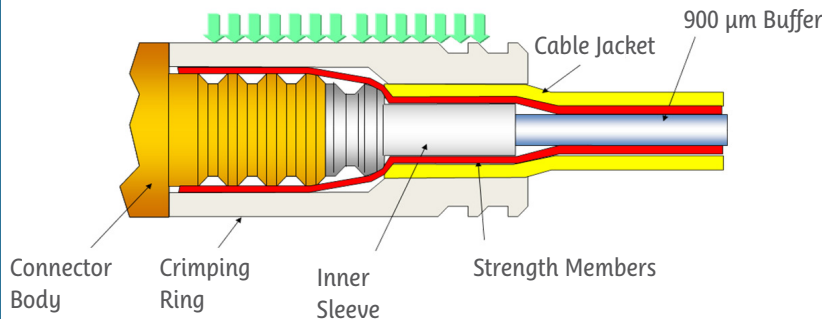

Using a crimp tool, firmly crimp the crimp ring of the terminus.



Processes and Radiall Technologies

CURING

5-Curing/Polymerization

Typically, polymerization is made by a hot process, however, it can also be done at ambient temperatures for field installations.

Place the termini in the curing unit cavities and **heat cure the resin** to the recommended temperature and for the recommended duration.



Incomplete polymerization weakens the fiber and may cause it to break during cleaving and polishing.

CLEAVING

6-Cleaving

Cleave the excess fiber from terminus end. Apply a gentle but straight pressure at the end of the fiber to break it clean at the cut.

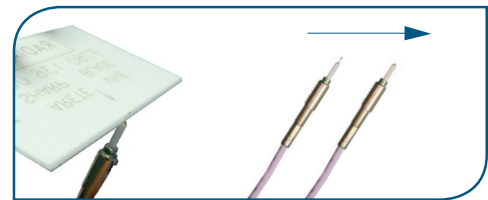

DEBURRING

7-Deburring

Polish off the end of the fiber by lightly running the abrasive paper over the top of the terminus tip to remove any remaining resin or fiber at the end of the ferrule.

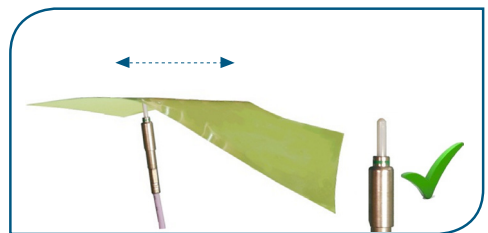

To terminate fiber optic cables with an optimized process, Radiall provides high-end kits with a detailed procedure and everything you need for a reliable and easy termination process. Refer to section 11, tool kits & accessories, for more information.

Processes and Radial Technologies

POLISHING PROCESS

The polishing process is crucial to get the smoothest end face to guarantee the lowest losses and most reliable connection. There are two techniques that can be used: manual polishing or mechanical polishing.



- Always make sure all your tools are properly prepared and cared for.
- Change polishing film regularly.
- Don't over-polish, you'll create a concave fiber surface, increasing the loss.

Manual Polishing:

Used in the field, manual polishing is a practical technique which allows a medium end face quality with a small amount of time and material. However practical and field friendly, the manual polishing technique will not guarantee various parameters:

- Radius of Curvature
- Apex (critical in case of APC)
- Constant Visual Aspect (scratches)
- UPC (50 dB)

Refer to your termini supplier for the best adapted process (time, motion, tool) for manual polishing.

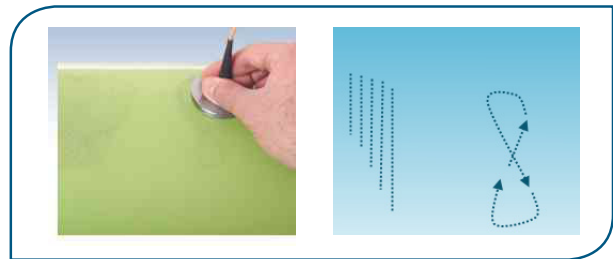

Mechanical Polishing:

Mechanical polishing guarantees the highest quality with a high level of consistency from batch to batch. PC, UPC and APC polishing grades are possible on automatic polishing machines; either on collective polishing machines dedicated to mass production or on unitary polishing machines for small volumes of production or field application.

Benefits:

- Permits APC, UPC and PC polishing
- Low and high volume polishing possible
- Quality consistency from one termini to the other
- Time saving
- Safe repolishing process if necessary



Processes and Radiall Technologies

WORK STATION SET UP

1-Preparation of the Work Station

Always work in the cleanest environment possible. Polishing films must be verified every day before use due to tool wear.

Plug and turn your polisher on.

Set up your mechanical polisher for load up and load down.

Install the right polishing jig.

Install the terminus in the jig.

Depending on the polishing program, install the adapted polishing pad and film. Always put some demineralized water between the film and the pad to create a vacuum effect and immobilize the film on the pad.

Dispense 1 to 2 ml of demineralized water on the film on the area where the ferrule will touch the film and lower the jig to put the terminus in polishing position.

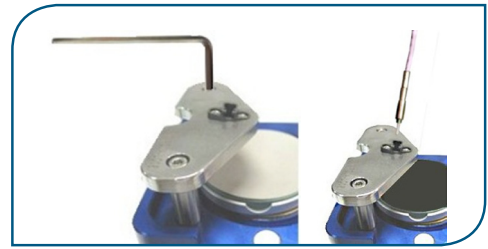

POLISHING

2-Polish

Start your polishing program. Clean plate and contact with demineralized water after each step.



CLEANING

3-Clean

When the program is complete, remove the termini.

Remove pad and film from the machine and thoroughly clean the polisher.

Inspect the optical end face.



To polish fiber optic termini with an optimized process, Radiall provides high-end kits with a detailed procedure and adapted tools. Refer to section 11, tool kits & accessories, for more information.

Radiall offers pre-angled connectors (LC & SC series) with a 8° pre-polishing of the ferrule for faster fiber termination process.

Radiall can also provide the complete set of tools for manual polishing.





Processes and Radiall Technologies

VISUAL INSPECTION

Various types of contaminations and defects of the optical end face may weaken or disrupt the signal. Their origins range from environmental to uncompleted termination and polishing processes. To optimize optical losses during the optical system integration, Radiall recommends inspecting each connection side before mating.

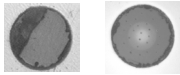
Best practice: [Inspect before you connect](#)

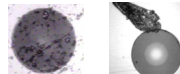
Types of contaminations and visual inspection criteria based on ARINC 805-3

Visual inspection criteria	Not permitted examples	Zone A Core area	Zone B Cladding area	Zone C Adhesive bond area	Zone D Ferrule area
Cracks		None	None	No limit of size or number	None
Chips/pits/contamination		Not to exceed 5% of total area	Not to exceed 10% of total area	No limit of size or number	No limit of size or number
Scratches		No more than 3 $\geq 3 \mu\text{m}$ in width, any length	No more than 6 μm in width, no limit on number	No limit of size or number	No limit of size or number
Debris		None $\geq 3 \mu\text{m}$	None $\geq 3 \mu\text{m}$	Max 5 pieces of debris $\leq 10 \mu\text{m}$ in diameter	Max 5 pieces of debris $\leq 10 \mu\text{m}$ in diameter
Film/oil		None	None	None	None

The quality of the inspection varies according to the tool you use, we recommend the use of a digital microscope with a 200x to 400x magnification.

Benefits of using Radiall recommended inspection tools:

- Automated Pass/Fail analysis
- Automatic fiber-image centering
- Select your microscope according to your precision needs.
- Select your tip according to the configuration (polishing, ferrule size, in or out multipin connectors)
- Select your barrel according to your tip



Manual fiberscopes are also available but offer a less clear view of the end faces:

- Can't come close to the ferrule end face
- Difficulties to view APC polished end faces
- Not practical when inspecting in multipin connectors
- Subjectivity of the technician inspecting



Processes and Radial Technologies

END FACE GEOMETRY & INTERFEROMETRY

Importance of the End Face Geometry:

The geometry of the end face determines which areas come into contact when two connectors or termini are mated. It allows controlling the performance of the connector and assessing its compliance to the standards. Measuring end face parameters such as the radius of curvature, the apex offset and the fiber height after termination and polishing process provides quality control and quality assurance.

Measurement Technique:

The interferometer is one of the most common instruments that can provide information on the end face geometry. It is widely used in science and industry for the measurement of small displacements, refractive index changes and surface irregularities.

Interferometry uses light waves to measure the surface in three dimensions. This makes it the preferred method for analyzing fiber optic end faces because it provides accurate and immediate information on the entire surface topography.

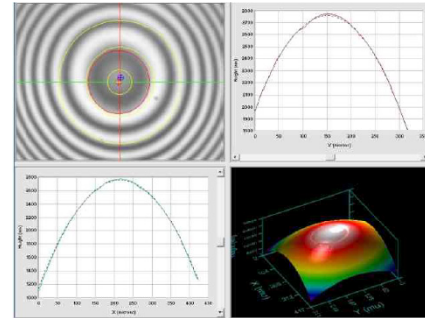

Key Measurement Parameters:

Radius of Curvature:

The end face of ferrules is domed to ensure that the contact area between mating connectors is at the center of the ferrule. The radius of this dome is called the "Radius of curvature". If the radius is too low, there will be a smaller contact area thus putting more force on the fiber during mating. If the radius is too high, physical contact between the two fibers may not be achieved because there will be a larger contact area resulting in less ferrule deformation. Measurement is performed by calculating the best fitting sphere over this area.

Apex Offset:

Apex offset is a measure of the distance between the highest point of the convex of the polished end face and the center of the fiber. The objective is for the center of the fiber to be the highest point on the end face, thus guaranteeing contact between mating fibers.

Fiber Height:

Fiber height is the difference in height between the center of the fiber and the theoretical height of the ferrule where the center would be when considered a continuous sphere. Both EIA/TIA and Bellcore standards allow a fiber height to be calculated based on the measured radius of curvature.

Example of an APC polished ferrule:

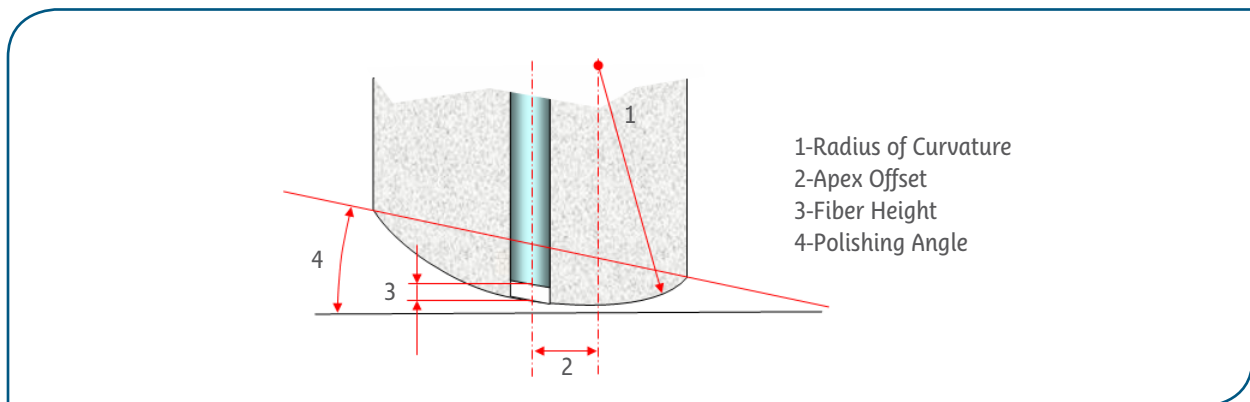

Processes and Radial Technologies

INSERTION LOSS (IL) AND RETURN LOSS (RL) MEASUREMENTS

In order to qualify how efficiently light is transmitted in a connection, we measure two key characteristics: Insertion Loss and Return Loss.

Insertion Loss Definition:

Insertion Loss (IL or attenuation) refers to the loss of signal power (light) resulting from the insertion of a device (for example a connector) in a transmission line or optical fiber. Insertion loss can result from absorption, misalignment or air gap between the fiber optic components. The smaller the IL, the better.

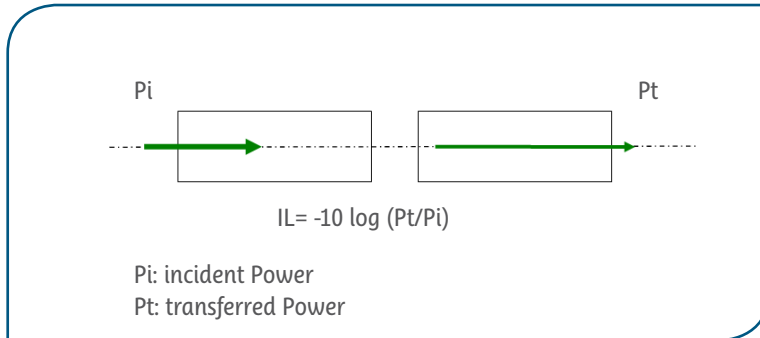

Return Loss Definition:

Return Loss (RL) is the ratio of the reflected optical power to the incident power. When light is transmitted into a connector, a portion of light is reflected back from the fiber end face. It is desirable for this figure to be as high as possible (meaning to have as little reflected light as possible) to avoid problems with transmission lasers.

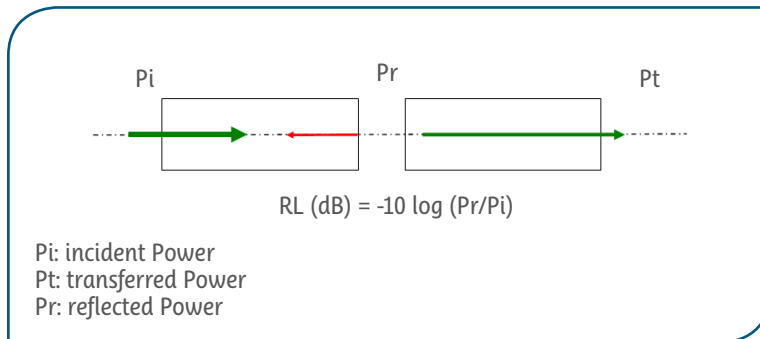

Measurements Standards:

IL and RL measurement methods are described in IEC 61300 standards (Fiber optic interconnecting devices and passive components) – Basic test and measurement procedures and ARINC 805 standard (Fiber Optic test procedures).

Specifically:

- IEC 61300-3-4: Examinations and measurements - Attenuation
- IEC 61300-3-34: Examinations and measurements - Attenuation of random mated connectors
- IEC 61300-3-6: Examinations and measurements - Return loss

Optical Active Devices

TRANSMITTER, RECEIVER AND TRANSCEIVER

Fiber optics communication requires active devices to convert electrical signals to optical ones in order to ensure the propagation of the information through optical fiber. Symmetrically opto-electronical conversion is needed to recover data at the end of fiber. An active device can be a transmitter, a receiver or a transceiver versus the way it handles optical and electrical signals, as sketched below:

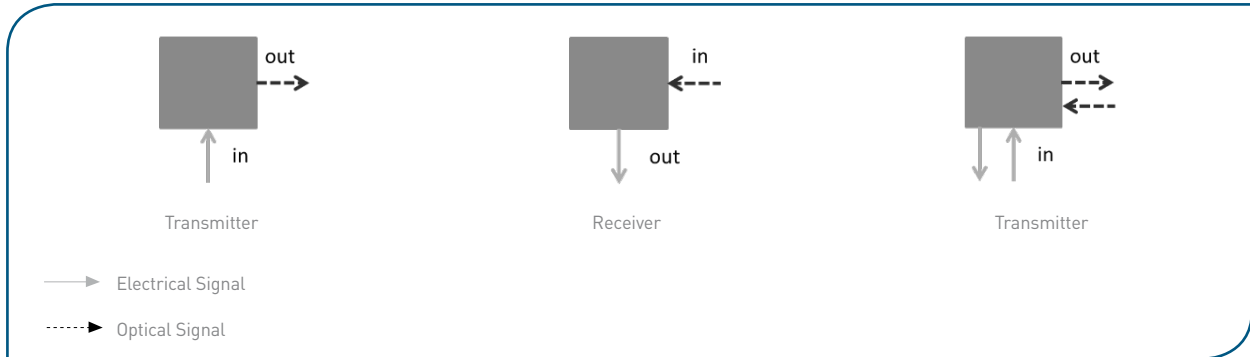

OPTICAL EXTINCTION RATIO (ER) AND OPTICAL MODULATION AMPLITUDE (OMA)

In digital communication, for bi-level coding schemes, the optical extinction ratio is the ratio of energy (power) used to transmit a logic level "1" to the energy used to transmit a logic level "0".

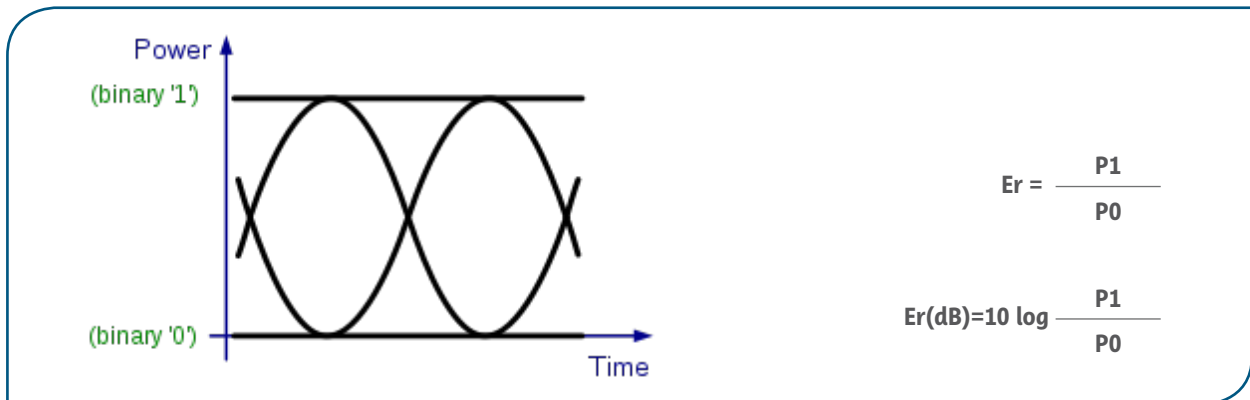

In an ideal transmitter P_0 would be zero, but in most situations, its lower value is limited by the laser threshold. For data link optimization, ER is set by manufacturers at the best compromise between the transmitter optical power requirement and the bit error rate of the link. The Optical Modulation Amplitude, OMA, is defined as the difference between the high and low levels:

$$OMA = P1 - P0$$

P_{avg} is defined as the average between the two power levels:
$$P_{avg} = \frac{P1 + P0}{2}$$

Optical Active Devices

OMA is a function of average launch power (Pavg) and extinction Ratio (Er):

$$OMA = 2 \cdot P_{avg} = \frac{Er - 1}{Er + 1}$$

The following chart shows the relationship between Er, Pavg and OMA parameters

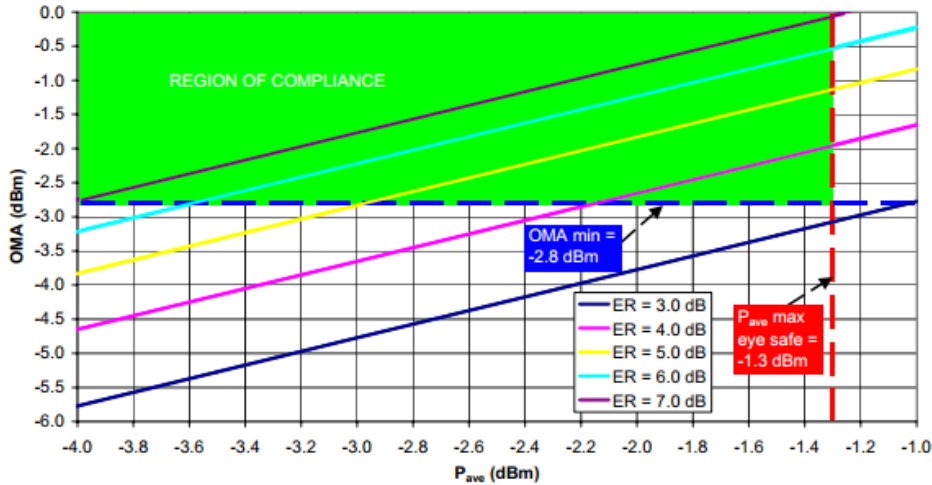

Then, for every transmission link configuration a region of compliance can be defined, setting the range of values that Er, OMA and Pavg need to comply with to fulfill the targeted standard.

The above chart shows for instance the region of compliance [Pavg-OMA] to fulfill the 802.3ae 10GBASE-S TX standard. The **dashed blue line** shows the minimum OMA set by the standard (-2.8 dBm) and the **dashed red line** shows the Class1 eye safety limit over wavelength range of 840-860 nm (IEC 60825-1 2001) for the related optical source.

The intersection of the graphed lines with the minimum OMA (**dashed blue**) line defines the minimum compliant average power. For example, this occurs at an average power equal to -3 dBm for Er=5 dB. This is a useful low-end setting for Er; lower values would not provide enough operating range for average optical power. Higher extinction ratios (>6 dB) are more desirable.

For a digital optical data link, the receiver sensitivity is the minimum average received optical power required to achieve a fixed BER (Bit Error Rate). The BER is the ratio of error bits to the bits sent over a certain time interval.

The optical sensitivity and the transmitter average power are used to calculate the power budget of the optical transmission link. The power budget is the difference between the minimum Pavg and the maximum receiver sensitivity.

For example, with a Pavg of -4 dBm and a receiver sensitivity of -17 dBm, the transceiver budget is 13 dB. That value sets the amount of losses affordable for the link, achieving the targeted BER.

Glossary of Terms

APC connector: Angled Physical Contact connector with the end-face polished at 8° (or 9° in some cases). This polishing profile provides very low back reflection (RL>65 dB).

Attenuation: Reduction of signal magnitude, or loss, normally measured in decibels. Fiber attenuation is measured at a specified wavelength in decibels per kilometer. The decrease in signal strength along a fiber optic waveguide caused by absorption and scattering. Attenuation is usually expressed in dB/km.

Bandwidth: The highest frequency that can be transmitted by an analog system. Also, the information-carrying capacity of a system (especially for digital systems). The range of frequencies within which a fiber optic waveguide or terminal device can transmit data or information.

Bend radius: The smallest radius an optical fiber or fiber cable can bend before excessive attenuation or breakage occurs.

Bit: The smallest unit of information upon which digital communications are based; also an electrical or optical pulse that carries this information.

Bonding: Gluing technology to immobilize the fiber inside the optical ferrule.

Breakout Cable: A type of fiber optic cable containing several fibers, each with its own jacket and all of them surrounded by one common jacket.

Broadcast Transmission: Sending the same signal to many different places, like a television broadcasting station. Broadcast transmission can be over optical fibers if the same signal is delivered to many subscribers.

Buffer: The fiber buffer layer is a polymeric coating applied over the cladding glass principally for the purpose of protecting the optical fiber from mechanical damage. Fabrication techniques include both tight jacket or loose tube buffering, as well as multiple buffer layers.

Bulkhead panel mounting: Panel attachment of a connector using a screw and nut feed through technology.

Cladding: The layer of glass or other transparent material surrounding the light-guiding core of an optical fiber. The clad has a lower refractive index than the core thereby confining light in the core by the process of total internal reflection.

Coating: An outer plastic layer applied over the cladding of a fiber for mechanical protection. The material surrounding the cladding of a fiber. Generally a soft plastic material that protects the fiber from damage.

Core: The central area of an optical fiber which serves as a waveguide. It has a refractive index higher than the surrounding cladding.

Crimp Sleeve: A crimped metal cylinder that holds the connector to the cable through the cable's strength member.

Data Rate: The number of bits of information in a transmission system, expressed in bits per second (b/s or bps), and which may or may not be equal to the signal or baud rate.

Duplex: In cables, one that contains two fibers. For connectors, one that connects two pairs of fibers.

Electromagnetic Interference (EMI): Noise generated when stray electromagnetic fields induce currents in electrical conductors.

End face: Term often used to describe the end of a ferrule. The end face is finished or polished to have a smooth end, which can minimize connector loss or backreflection. Typical polish types are PC, UPC, and APC.

Glossary of Terms

Fan-Out: A multi-fiber cable constructed in a tight buffered tube design. At a termination point, cable fibers must be separated from the cable to their separate connection positions.

Ferrule: A cylindrical part, usually ceramic, which holds and aligns the fiber in a connector.

Fiber buffer: Consists of one or more materials that is used for protecting the individual fibers from damage and provides mechanical isolation and/or mechanical protection.

Flange mount: Panel connector screwed into the wall and requiring several holes (5 holes for square flange, 3 holes for rectangular flange).

Graded-index fiber: An optical fiber where the core has a non-uniform refractive index. The core is composed of the glass where the refractive index decreases from the center axis with a predetermined profile. The purpose is to reduce modal dispersion and thereby increase fiber bandwidth.

IEC: International Electro technical Commission.

Index of Refraction: The ratio of the velocity of light in free space to the velocity of light in a given medium.

Insertion Loss: The loss of power that results from inserting a component, such as a connector or splice, into a previously continuous path.

Interferometer: An instrument that employs the interference of lightwaves to measure the accuracy of optical surfaces; it can measure a length in terms of the length of a wave of light by using interference phenomena based on the wave characteristics of light. Interferometers are used extensively for testing optical elements during manufacture. Typical designs include the Michelson, Twyman-Green and Fizeau interferometers

ISO: Abbreviation for International Standards Organization. Established in 1947, ISO is a worldwide federation of national standards committees from 140 countries. The organization promotes the development of standardization throughout the world with a focus on facilitating the international exchange of goods and services, and developing the cooperation of intellectual, scientific, technological and economical activities.

Jacket: The outer, protective covering of the cable. Also called the cable sheath.

Jumper Cable: A short single fiber cable with connectors on both ends used for interconnecting other cables or testing.

Key: A feature of a terminus that prevents the terminus from rotating when it is installed in a connector. This ensures proper alignment of tuned termini and termini that use an APC polish. The key also prevents torsion stress from being applied to the portion of the fiber that is within the terminus.

Large-Core Fiber: Usually, a fiber with a core of 200 μm or more.

Local-Area-Network (LAN): A network that transmits data among many nodes in a small area (e.g. a building or campus). A communication link between two or more points within a small geographic area, such as between buildings. Smaller than a metropolitan area network (MAN) or a wide area network (WAN).

Loose structure cable: A fiber optic cable structure that allows limited movement of the fiber with respect to the outer jacket and strength member.

Mechanical ferrule/crimp ferrule: Immobilization technology used to secure the connector at the extremity of the fiber.

Glossary of Terms

MIL-SPEC: Abbreviation for military specification. Performance specifications issued by the Department of Defense that must be met in order to pass a MIL-STD.

MIL-STD: Abbreviation for military standard. Standards issued by the Department of Defense.

Mode: In guided-wave propagation, such as through a waveguide or optical fiber, a distribution of electromagnetic energy that satisfies Maxwell's equations and boundary conditions. Loosely, a possible path followed by light rays.

Optical ferrule: Guide pin for fiber connectors in which the fiber is secured (generally ceramics).

Return Loss (RL): The ratio (expressed in dB) of optical power reflected by a component or an assembly to the optical power incident on a component port when that component or assembly is introduced into a link or system.

PC: Abbreviation for Physical Contact. Refers to an optical connector that allows the fiber ends to physically touch. Used to minimize backreflection and insertion loss.

Pull-proof: A fiber optic cable and connector construction such that a pull applied to a single fiber behind the connector will not move or separate the ferrule end faces.

Profile Dispersion: Dispersion attributed to the variation of refractive index contrast with wavelength.

Refraction: The change in direction experienced by a ray (wave) when it passes between different materials having different refractive indices.

Step-index: An optical fiber core that has a uniform refractive index. This construction has a large modal dispersion as compared to graded-index fiber. This leads to pulse widening and limits the bandwidth as the pulses blur into one another.

Strength Member: The part of a fiber optic cable composed of aramid yarn, steel strands or fiberglass filaments that increase the tensile strength of the cable.

Termination: Preparation of the end of a fiber to allow connection to another fiber or an active device, sometimes also called "connectorization".

Tight structure cable: A fiber optic cable structure that allows no movement of the fiber with respect to the outer jacket.

Part Number Index



Index

Part Number Index



Radiall Part Numbers

Part Number	Page	Part Number	Page	Part Number	Page	Part Number	Page
282515.....	1-11	F718069000.....	4-19, 4-23	F718162205.....	4-20	F718207206.....	4-20
..... 11-4,11-10, 11-11		F718044000.....	4-19	F718162206.....	4-20	F718207207.....	4-20
282549001.....	2-11	F718064000.....	4-23	F718162209.....	4-20	F718207208.....	4-20
282549009.....	2-11	F718100000.....	4-18	F718166200.....	4-20	F718207209.....	4-20
620946001.....	2-11	F718101000.....	4-18	F718166201.....	4-20	F718211200.....	1-11
620946002.....	2-11	F718102000.....	4-18	F718166202.....	4-20	F719058000.....	1-8
620946003.....	2-11	F718103200.....	4-21	F718166203.....	4-20	F719058010.....	1-8
620946004.....	2-11	F718103201.....	4-21	F718166204.....	4-20	F719060000.....	1-8
EPXAEF6PA.....	2-8	F718103202.....	4-21	F718166205.....	4-20	F725000419.....	1-6
EPXAEF6SA.....	2-8	F718103203.....	4-21	F718166206.....	4-20	F725000519.....	1-6
EPXBE12F6PA.....	2-8	F718103204.....	4-21	F718166209.....	4-20	F725003419.....	1-6
EPXBE12F6PB.....	2-8	F718103205.....	4-21	F718169200.....	4-20	F725003519.....	1-6
EPXBE12F6SA.....	2-8	F718103206.....	4-21	F718169201.....	4-20	F725050419.....	1-6
EPXBE12F6SB.....	2-8	F718103210.....	4-21	F718169202.....	4-20	F725050519.....	1-6
EPXBEF12CPA.....	2-8	F718104200.....	4-21	F718169203.....	4-20	F725700100.....	1-8
EPXBEF12CPB.....	2-8	F718104201.....	4-21	F718169204.....	4-20	F725701100.....	1-8
EPXBEF12CSA.....	2-8	F718104202.....	4-21	F718169205.....	4-20	F725745000.....	1-8
EPXBEF12CSB.....	2-8	F718104203.....	4-21	F718169206.....	4-20	F725xxxxxx.....	1-6
D-LIGHT.....	10-5	F718104204.....	4-21	F718170200.....	4-19, 4-22	LXCRxxxxxxxx.....	2-19
S-LIGHT.....	10-3	F718104205.....	4-21	F718175200.....	4-19	F727002500Y.....	4-6
F709020100Y.....	4-16	F718104206.....	4-21	F718176104.....	1-11	F727002520Y.....	4-6
F709150000Y.....	4-16	F718104210.....	4-21 11-4, 11-10, 11-11		F727003500Y.....	4-6
F709022000.....	4-14	F718105200.....	4-21	F718176204.....	1-11	F727003520Y.....	4-6
F709022200.....	4-14	F718105201.....	4-21	F718183204.....	4-19	F727052500Y.....	4-6
F709024000.....	4-14	F718105202.....	4-21	F718185200.....	4-21	F727052520Y.....	4-6
F709024200.....	4-14	F718105203.....	4-21	F718186200.....	4-21	F727102000.....	4-4, 4-22
F709025200.....	4-14, 4-23	F718105204.....	4-21	F718193200.....	4-20	F727102100.....	4-4
F709034200.....	4-14, 4-23	F718105205.....	4-21	F718193201.....	4-20	F727102500.....	4-4
F709034706.....	4-14, 4-23	F718105206.....	4-21	F718193203.....	4-20	F727102700.....	4-4
F709036200.....	4-14, 4-23	F718105210.....	4-21	F718193204.....	4-20	F727103000.....	4-4, 4-22
F709089000.....	4-15	F718106200.....	4-18, 4-23	F718193205.....	4-20	F727103100.....	4-4
F709090000.....	4-14	F718107200.....	4-19, 4-23	F718193206.....	4-20	F727103110.....	4-4
F709096200.....	4-14	F718108200.....	4-19	F718193209.....	4-20	F727103500.....	4-4
F709097200.....	4-14	F718109200.....	4-19, 4-23	F718197006Y.....	4-6	F727103510.....	4-4
F709098200.....	4-14	F718111220.....	4-19	F718197200.....	4-18	F727103700.....	4-4
F709400000.....	4-17	F718145200.....	4-19	F718197201.....	4-18	F727103710.....	4-4
F709401000.....	4-17	F718146200.....	4-19	F718197205.....	4-18	F727132100.....	4-5
F709722000.....	4-17	F718158200.....	4-18, 4-22	F718197206.....	4-18	F727132500.....	4-5
F709722200.....	4-17	F718160200.....	4-19, 4-22	F718207200.....	4-20	F727152000.....	4-4, 4-22
F709724000.....	4-15	F718162200.....	4-20	F718207201.....	4-20	F727152100.....	4-4
F709730000.....	4-17	F718162201.....	4-20	F718207202.....	4-20	F727152500.....	4-4
F709730200.....	4-17	F718162202.....	4-20	F718207203.....	4-20	F727152700.....	4-4
F709750000.....	4-19	F718162203.....	4-20	F718207204.....	4-20	F727402500.....	4-5
F709760000.....	4-19	F718162204.....	4-20	F718207205.....	4-20	F727402700.....	4-5

Radiall Part Numbers

Part Number	Page	Part Number	Page	Part Number	Page	Part Number	Page
F727403500.....	4-5	F728102100.....	4-9	F760855620-xx	9-11	F780533001.....	11-3
F727403700.....	4-5	F728102500.....	4-9	F760855640-xx	9-12	F780533002.....	11-3
F727452500.....	4-5	F728102700.....	4-9	F760858220.....	9-10	F780533003.....	11-3
F727452700.....	4-5	F728103000.....	4-9, 4-23	F760858240.....	9-10	F780538000.....	1-9
F727502500.....	4-5	F728103100.....	4-9	F760858620-xx	9-11	11-3, 11-4
F727503500.....	4-5	F728103101.....	4-9	F760858640-xx	9-12	F780539000.....	1-9
F727503700.....	4-5	F728103500.....	4-9	F760885620-xx	9-11	11-3, 11-9
F727552500.....	4-5	F728103501.....	4-9	F760885640-xx	9-12	F780541000.....	1-9
F727710000.....	4-7	F728103700.....	4-9	F760888620-xx	9-11	11-3, 11-4
F727710100.....	4-7	F728103702.....	4-9	F760888640-xx	9-12	F780581000.....	11-14
F727710700.....	4-7	F728112000.....	4-9, 4-23	F780025000.....	11-10, 11-13	F780584000.....	11-7, 11-13
F727710710.....	4-7	F728112100.....	4-9	F780033000.....	F780633000.....	11-12
F727711000.....	4-7	F728112500.....	4-9	11-10, 11-12, 11-13	F780638000.....	1-11
F727711100.....	4-7	F728112700.....	4-9	F780034000.....	11-14	F780648000.....	11-11
F727711700.....	4-7	F728132100.....	4-10	F780039000.....	F780649000.....	11-11
F727711710.....	4-7	F728132700.....	4-10	..11-10, 11-12, 11-13, 11-14	F780652000.....	11-12
F727750000.....	4-7	F728158200.....	4-22	F780051000.....	11-14	F780725000.....	1-10
F727750100.....	4-7	F728700000.....	4-12	F780057000.....	11-10	11-6, 11-8
F727750700.....	4-7	F728700100.....	4-12	11-10, 11-12, 11-13	F780725001.....	1-10
F727750800.....	4-7	F728703000.....	4-12	F780073000.....	5-8	11-6, 11-8, 11-4
F727751000.....	4-7	F728703100.....	4-12	F780132000.....	11-10	F7807250XX	1-10,
F727751100.....	4-7	F728710000.....	4-12	F780136000.....	11-6
F727751700.....	4-7	F728710700.....	4-12	..11-10, 11-12, 11-13, 11-14	F7807251XX	1-10
F727752000.....	4-7	F728713000.....	4-12	F780217000.....	11-6
F727752100.....	4-7	F728713100.....	4-12	11-10, 11-12, 11-13	F780725200.....	1-10
F727752710.....	4-7	F728713701.....	4-12	F780219000.....	11-13, 11-14	11-6
F727752800.....	4-7	F728743000.....	4-12	F780233000.....	11-13	F780725300.....	1-10
F727752810.....	4-7	F728743100.....	4-12	F780242010.....	11-6, 11-3
F727754000.....	4-7	F728743700.....	4-12	11-10, 11-12, 11-13	F780726000.....	11-3
F727754100.....	4-7	F728750000.....	4-12	F780243000.....	11-13, 11-14	F780799000.....	1-8
F727754700.....	4-7	F728750100.....	4-12	F780290000.....	11-12	F780799001.....	1-8
F727754710.....	4-7	F728750700.....	4-12	F780318000.....	11-13	F780809000.....
F728003500Y.....	4-11	F728753000.....	4-12	F780428000.....	11-3	..11-11, 11-12, 11-13, 11-14
F728003520Y.....	4-11	F728753100.....	4-12	F780429000.....	11-3	F780811000.....
F728002100.....	4-9	F728753700.....	4-12	F780463000.....	11-13	11-12, 11-10, 11-13
F728002500.....	4-9	F728753701.....	4-12	F780483000.....	11-12	F780812000.....
F728002700.....	4-9	F730xxxxxxxxxxx	3-13	F780495100.....	11-10	11-12, 11-10, 11-13
F728003100.....	4-9	F739xxxxxxxxxxx	3-8	F780496100.....	11-10	F780825000.....
F728003500.....	4-9	9-25	F780503000.....	11-10, 11-14	11-12, 11-10, 11-13
F728003700.....	4-9	F746xxxxxxxxxxx	3-10	F780504000.....	11-10, 11-14	F780826000.....
F728012100.....	4-9	F760555612-xxx.....	9-15	F780508000.....	11-12, 11-10, 11-13
F728012500.....	4-9	F760555670-xxx.....	9-15	11-10, 11-12, 11-13	F780827000.....
F728012700.....	4-9	F760855220.....	9-10	F780527000.....	11-12, 11-10, 11-13
F728102000.....	4-9, 4-23	F760855240.....	9-10	11-10, 11-12, 11-13	F780844000.....	11-9

Radiall Part Numbers

Part Number	Page	Part Number	Page	Part Number	Page	Part Number	Page
F780850000.....	11-9	F780898001.....	1-10	F792130801.....	11-17	R2CT107000.....	6-6
F780854002.....	11-9	11-6, 11-8	F792131800.....	11-17	R2CT107018.....	6-6
F780854003.....	11-9	F780899000.....	11-4, 11-7	F792131801.....	11-17	R2CT107100.....	6-7
F780858000.....	2-11	F780902000.....	F792373800.....	11-17	R2CT107200.....	6-7
F780860000.....	1-9	11-4, 11-7, 11-10	F792390800.....	11-16	R2CT107300.....	6-7
.....	11-9	F780903000.....	11-4, 11-7	F792393800.....	11-16	R2CT125000.....	6-5
F780861000.....	1-9	F780904000.....	11-4, 11-7	F792500800.....	11-16	R2CT125001.....	6-5
.....	11-9, 11-10	F780905000.....	11-4, 11-7	F792510800.....	11-16	R2CT127000.....	6-5
F780862000.....	1-9	F780906000.....	11-7	F792530801.....	11-16	R2CT127001.....	6-5
.....	11-9, 11-8, 11-10	F780906001.....	11-4, 11-7	OPUS107200.....	8-5	R2CT135000.....	6-9
F780880000.....	11-10	F780906002.....	OPUS117200.....	8-4	R2CT157000.....	6-7
F780886000.....	11-11	11-4, 11-7, 11-8	OSIS107000.....	7-6	R2CT157001.....	6-7
F780887000.....	11-11	F780906003.....	OSIS107001.....	7-6	R2CT945000.....	6-9
F780888000.....	11-11	11-4, 11-7, 11-8	OSIS107002.....	7-6	R2CTC855700-01.....	9-13
F780889000.....	11-4, 11-7	F780906004.....	11-7	OSIS107003.....	7-6	R2CTC855700-02.....	9-13
F780890000.....	F780906005.....	11-7	OSIS107100.....	7-7	R2CTC855700-03.....	9-13
.....	11-4, 11-7, 11-8	F780906006.....	11-8	OSIS107101.....	7-7	R2CTC858700-01.....	9-13
F780890002.....	11-8	F780906007.....	11-8	OSIS107102.....	7-7	R2CTC858700-02.....	9-13
F780890003.....	11-8	F792100800.....	11-17	OSIS107103.....	7-7	R2CTC858700-03.....	9-13
F780891000.....	F792101800.....	11-17	OSIS107104.....	7-7	RXF.....	5-4
.....	11-4, 11-7, 11-8	F792110800.....	11-17	OSIS107105.....	7-7	R8xxxxxxxxxxx.....	2-16
F780893000.....	11-11	F792110801.....	11-17	OSIS115000.....	7-4	R9xxxxxxxxxxx.....	2-17
F780893001.....	11-11	F792111800.....	11-17	OSIS115001.....	7-5	STANDARD JUMPERS.....	1-13
F780897000.....	11-4	F792111801.....	11-17	OSIS990000.....	7-4	9-6, 9-20
F780898000.....	11-4, 11-7	F792130800.....	11-17	R2CT105000.....	6-6		

NOTES

Notes



Our most
important
connection
is with you.™

It's not just a slogan. It's a statement of our earnest desire to put you at the forefront of all our business practices. As part of Radiall's mission to be available and accessible, we make it a priority to have local offices around the globe ready and able to assist you – wherever you are, whenever you need us.

Europe

	ADDRESS	PHONE	FAX	EMAIL
FINLAND	Radiall Finland PO Box 202 - 90101 Oulu	+358 407522412		infofi@radiall.com
FRANCE	Radiall SA 25 Rue Madeleine Vionnet - 93300 Aubervilliers	+33 (0)1 49 35 35 35		info@radiall.com
GERMANY	Radiall GmbH Carl-Zeiss Str. 10 - D 63322 Rödermark	+49 60 74 91 07 0	+49 60 74 91 07 10	info@radiall.com
ITALY	Radiall Elettronica S.R.L Via Della Resistenza 113 - 20090 Buccinasco Milano	+39 02 48 85 121	+39 02 48 84 30 18	infoit@radiall.com
NETHERLANDS	Radiall Nederland BV Hogebrinkerweg 15b - 3871 KM Hoevelaken	+31 (0)33 253 40 09	+31 (0)33 253 45 12	info@radiall.com
SWEDEN	Radiall AB Sollentunavägen 63 - 191 40 Sollentuna	+46 8 444 34 10		infose@radiall.com
UNITED KINGDOM	Radiall Ltd 6 Union Park - Packet Boat Lane - Uxbridge, Middlesex UB8 2GH	+44 (0)1895 425000	+44 (0)1895 425010	info@radiall.com

Asia

	ADDRESS	PHONE	FAX	EMAIL
CHINA	Shanghai Radiall Electronics CO, Ltd N° 390 Yong He Rd SHANGHAI 200072 P.R.C	+86 21 66523788	+86 21 66521177	info@radiall.com
HONG KONG	Radiall Electronics (Asia) Ltd Flat D, 6/F, Ford Glory Plaza, 37-39 Wing Hong Street - Cheung Sha Wan - Kowloon - Hong Kong	+852 29593833	+852 29592636	infohk@radiall.com
INDIA	Radiall India Pvt. Ltd 25.D.II phase Peenya Industrial Area. Bangalore-560058	+91 80 83 95 271	+91 80 83 97 228	infoin@radiall.com
JAPAN	Nihon Radiall Shibuya-Ku Ebisu 1-5-2, Kougetsu Bldg 405 - Tokyo 150-0013	+81 3 34406241	+81 3 34406242	infojp@radiall.com

Americas

	ADDRESS	PHONE	FAX	EMAIL
USA & CANADA	Radiall USA, Inc. 8950 South 52nd Street Ste 401 Tempe, AZ 85284	+1 480-682-9400	+1 480-682-9403	info@radiall.com

Also Represented In...

AUSTRALIA AUSTRIA BELGIUM BRAZIL CZECH REPUBLIC DENMARK ESTONIA GREECE HUNGARY INDONESIA ISRAEL KOREA LATVIA LITHUANIA
MALAYSIA NORWAY PHILIPPINES POLAND PORTUGAL RUSSIA SINGAPORE SPAIN SWITZERLAND TAIWAN THAILAND VIETNAM SOUTH AFRICA