



QUICK-LOCK: QMA/WQMA/QN/QRE™

R123/R123W/R164/R324

Contents**QMA and WQMA**

Introduction	8-4 to 8-5
Characteristics	8-6 to 8-7
QMA plugs and jacks	8-8 to 8-9
QMA receptacles	8-9 to 8-10
QMA accessories and adapters	8-11 to 8-12
QMA panel drilling and assembly instructions	8-12 to 8-13
WQMA plugs, jacks and receptacles	8-14

QN

Introduction	8-4 to 8-5
Characteristics	8-15 to 8-16
Plugs and jacks	8-16 to 8-18
Receptacles	8-18 to 8-19
Adapters	8-19
Protective cap	8-20
Panel drilling	8-20

QRE™

Introduction	8-21
Characteristics	8-21
Plugs, jacks and receptacles	8-22
Adapters	8-23
Panel drilling	8-23

Introduction

"Quick-Lock Formula™" - A cost saving solution

Radiall's patented QMA and QN connectors are now the standard for the RF telecommunication industry. The "QLF" registered trademark, Quick-Lock Formula™ standard, applies to the QMA and QN series and guarantees the full intermateability between suppliers using this trademark. Using QLF™ certified connectors also guarantees the highest RF transmission performance.

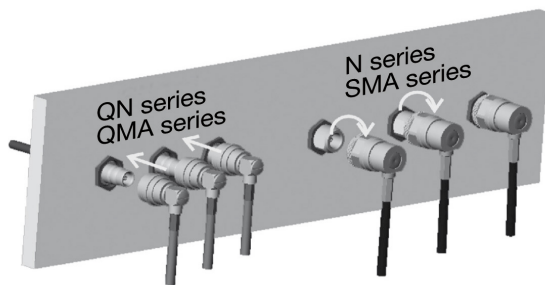

QMA (Quick-Lock SMA) and QN connectors (Quick-Lock N) enable fast, secured, and easy matings with minimum space requirements. The QMA and QN series are the perfect alternative to SMA and N connectors in new generation telecommunication systems as well as in many other RF applications.

**Saves installation time**

QMA and QN connectors are ten times faster to connect compared to N or SMA connectors, reducing the cost of ownership. With their snap-on interface, it takes only two seconds to connect QN and SMA connectors in field conditions.

Secure connection

The snap-on connection is insured by a chamfer. In addition, a positive locking system ensures an excellent and secure connection. The disengagement force is lower than the panel tear-off force, preventing any panel damage. QN and QMA connectors have been successfully tested against vibration.

Offers flexibility

The cabled plug can freely rotate around the jack, which allows for more flexibility during the mounting process and eases the installation within the equipment.



In addition, it prevents from any added stress on the cable and return loss reduction due to cable bending. As no torque wrench is required, the risk in damaging or scratching the panel is eliminated.

Introduction

Space saving

QN and QMA connectors have a lower space requirement since space for the use of a torque wrench is not necessary. Therefore the distance between connectors is optimized on the panel.

QMA series

The QMA series with Quick-Lock Formula™, is the innovative patented snap-on generation of brass SMA connectors. With the same interface dimensions, QMA connectors have the identical high electrical performance as the SMA series with an easier and faster mounting design. The QMA series is a cost effective solution for the new generation of base stations. The QMA series is designed for DC to 18 GHz. This series features 100 matings and total reliability as the standard commercial SMA connectors. They are fast and easy to connect and disconnect. The new QMA series offers a large range of connectors: straight and right angle plugs, bulkhead jacks, flange receptacles, PCB receptacles, adapters and more. Models are either full crimp, crimp or solder type for flexible, semi-rigid or conformable cables.

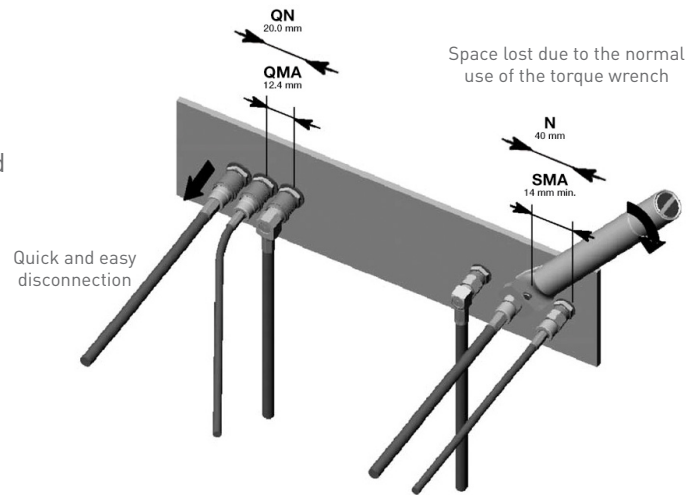

WATERPROOF QMA series

Radiall expands its QMA product line with new high density RF coaxial **Waterproof QMA (WQMA)** connector solutions with fast and easy snap-on Quick Lock technology. WQMA connectors offer outstanding electrical performance and have environmental characteristics that provide for long lasting durability needed for the most demanding harsh outdoor applications, thus eliminating the need for costly and bulky watertight enclosures or cable entries.

Waterproof QMA CONNECTORS are fully intermateable and backward compatible with any QLF™ certified standard QMA connectors and they provide for excellent ingress protection.

- IP 68 rating when mated
- 100 matings minimum for durability
- Wide temperature range -40°C / +105°C
- Power rating 200W @ 1 GHz, 75°C

QN series

Offering the same operating frequency range between DC and 11 GHz as the N series, the new QN series performance has been **optimized from DC to 6 GHz for 50Ω applications**. The new QN interface typically features a VSWR of 1.05 from DC to 3 GHz and 1.12 from 3 to 6 GHz. The corresponding return loss is **32 dB from DC to 3 GHz and 25 dB from 3 to 6 GHz**. The high screening effectiveness enables a level of RF leakage as low as -90 dB from DC to 3 GHz and -80 dB from 3 to 6 GHz.

Designed for indoor and outdoor applications such as BTS, antenna systems or test and measurement devices, QN connectors offer an outstanding intermodulation level (-155 dBC / -112 dBm) and IP rating (water and dust protection). The power rating is **300 W at 2.5 GHz** and features **100 matings**.

QMA Characteristics

Test / Characteristics	Values / Remarks
ELECTRICAL CHARACTERISTICS	
Impedance	50Ω
Frequency range	DC - 6 GHz (optimized) DC - 18 GHz (working range)
Typical V.S.W.R. • DC - 3 GHz • 3 GHz - 6 GHz	1.06 1.12
Max insertion loss	0.25 dB
Insulation resistance	5000 MΩ
Voltage rating	≤ 500 V RMS 50 Hz, sea level
Dielectric withstanding voltage	1500 V RMS 50 Hz, sea level
Contact resistance • Center contact • Outer contact	< 3 mΩ < 2.5 mΩ
Admissible power @ 2.5 GHz (continuous power)	125 W @ T = 40°C (150 W @ T = 23°C)
Passive Intermodulation	-120 dBc @ 1.8 GHz (2x20W) (static)
RF leakage • DC - 3 GHz • 3 - 6 GHz	-80 dB min -70 dB min

MECHANICAL CHARACTERISTICS

Mechanical endurance	100 matings
Engagement and disengagement force • Engagement • Disengagement	25 N 20 N
Retention force for interface	> 60 N
Cable retention force 2.6 / 50 S 2.6 / 50 D 5 / 50 S 5 / 50 D 5.7 / 50 D	90 N 110 N 180 N 200 N 220 N
Distance between connectors: c. to c.	12.4 mm min.
Vibration	40 m.s ⁻² at 500 Hz

ENVIRONMENTAL CHARACTERISTICS

Temperature range	-40 °C, +105 °C
-------------------	-----------------

MATERIALS

Connector bodies	Brass
Male center contact	Brass
Female center contact	Beryllium copper
Outer contact	Bronze
Other metallic parts	Brass
Insulators	PTFE

PLATING

Bodies	BBR
Solder bodies	BBR
SMT Bodies	NPGR
Outer contacts	BBR
Center contacts	NPGR

All dimensions are given in mm.

QMA Characteristics

POWER RANGE

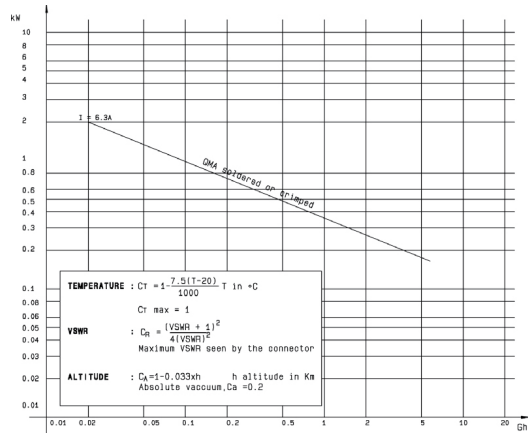

WQMA Characteristics

Test / Characteristics	Values / Remarks
ELECTRICAL AND MECHANICAL CHARACTERISTICS	
Impedance	50Ω
Frequency	DC - 6 GHz
V.S.W.R.	1.02 + 0.0200*F (GHz) Max
Center contact captivation	Yes
Working temperature range	- 40°C / + 105°C
Mating cycles	100

MATERIALS AND PLATING

	Materials	Platings
Connector body	Brass	BBR / NPGR / Gold over Copper
Male center contact	Brass	NPGR
Female center contact	Beryllium copper	NPGR / Gold over Copper
Outer contact and other metallic parts	Brass	BBR
Gasket	Silicone	
Insulator	PTFE	

ENVIRONMENTAL CHARACTERISTICS

Waterproofing	IP68	In mated condition
---------------	------	--------------------

QMA Plugs

STRAIGHT PLUGS

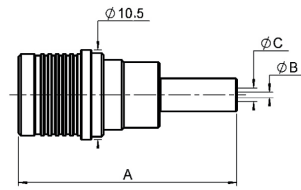

Fig. 1

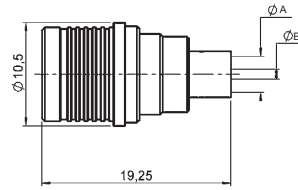

Fig. 2

Cable group	Cable group dia.	Part number	Fig.	Dimensions (mm)			Captive center contact	Finish	Packaging	Note		
				A	B	C						
RG174 / RG316 / AEP-100FR	2.6/50/S & LMR [®] 100	R123 071 000	1	25.5	0.6	1.61	Yes	BBR	100 pieces	Crimp type		
RD316	2.6/50/D	R123 072 000		25.5	0.6	1.61						
RG58 / RG141	5/50/S	R123 075 000		28.5	1.05	3.11						
RG142 / RG223 / RG400	5/50/D	R123 076 000	2	28.5	1.05	3.11						
RG405	.085"	R123 054 000		2.275	0.6	-						
RG402	.141"	R123 055 000		3.675	1	-						
AEP-195FR	LMR [®] 195	R123 075 200	1	28.5	1.05	3.11						Crimp type
AEP-200FR	LMR [®] 200	R123 096 110		28.5	1.18	3.25						
AEP-240FR	LMR [®] 240	R123 076 310		30.5	1.5	4.05						

Plugs

RIGHT ANGLE PLUGS

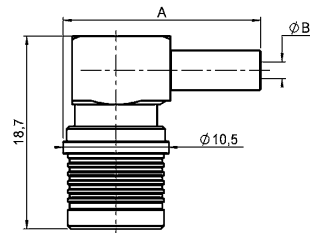

Fig. 1

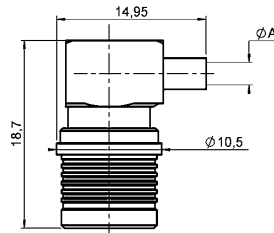

Fig. 2

A right angle plug for 5.7 mm dia. cable is also available, please consulte us.

Cable group	Cable group dia.	Part number	Fig.	Dimensions (mm)		Captive center contact	Finish	Packaging	Note		
				A	B						
RG174 / RG316	2.6/50/S	R123 172 000	1	19.7	0.6	Yes	BBR	100 pieces	Crimp type		
RD316	2.6/50/D	R123 174 000		19.7	0.6						
RG58 / RG141	5/50/S	R123 175 000		22.7	3.1						
RG142 / RG223 / RG400	5/50/D	R123 176 000		22.7	3.1						
AEP-240FR	LMR [®] 240	R123 177 100	2	22.65	4.05						Crimp type
RG405	.085"	R123 153 000		2.25	-						
		R123 153 003		2.25	-						
RG402	.141"	R123 154 000		3.7	-						
		R123 154 003	3.7	-	Gold			Solder type			
					BBR						
					Gold						

Jacks and Receptacles

STRAIGHT BULKHEAD JACKS

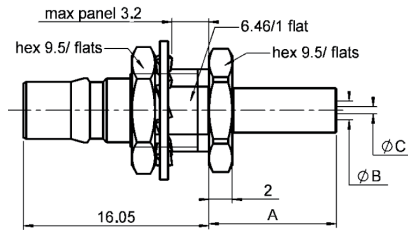

Fig. 1

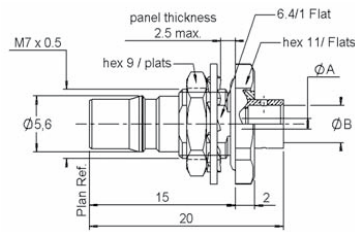

Fig. 2

Cable group	Cable group dia.	Part number	Fig.	Dimensions (mm)			Captive center contact	Panel drilling	Finish	Packaging	Note
				A	B	C					
RG174 / RG316	2.6/50/S	R123 312 000	1	11	0.6	1.61	Yes	P02	BBR	100 pieces	Full crimp type
RD316	2.6/50/D	R123 313 000		11	0.6	1.61					
RG58 / RG141	5/50/S	R123 314 000		14	1.05	3.11					
RG142 / RG223 / RG400	5/50/D	R123 315 000		14	1.05	3.11					
AEP-240FR	LMR® 240	R123 314 010	2	16	4.05	1.5	-	P02	Gold		Crimp type
RG405	.085"	R123 326 003		0.6	2.25	-					Solder type
RG402	.141"	R123 305 023		1	3.7	-					panel seal

STRAIGHT FLANGE FEMALE RECEPTACLES

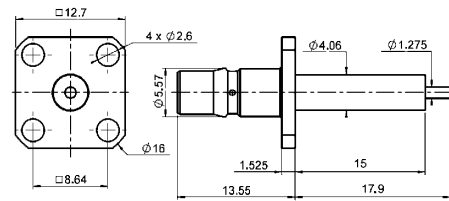

Fig. 1

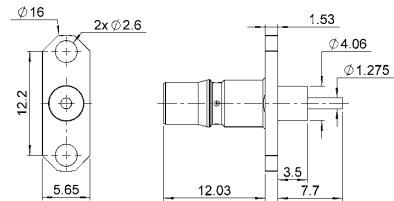

Fig. 2

Part number	Fig.	Captive center contact	Dimensions (mm)		Panel drilling	Finish	Note
			A	B			
R123 415 000	1	Yes	15	17.9	P01	BBR	Straight flange
R123 425 100			10	13			Straight flange Panel seal
R123 464 110	2	-	-	-	P04		Straight flange

RECEPTACLES

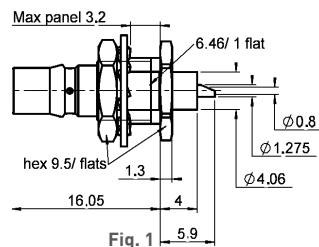

Fig. 1

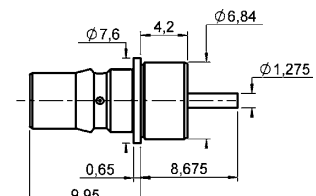
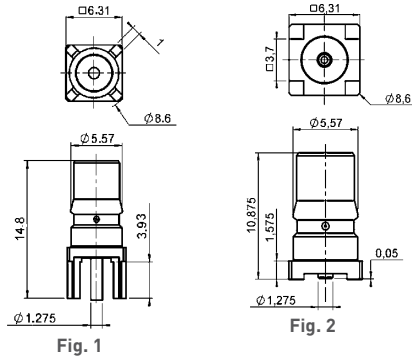

Fig. 2

Part number	Fig.	Captive center contact	Panel drilling	Finish	Note
R123 553 000	1	Yes	P02	BBR	Bulkhead receptacle
R123 590 027	2		P05	NPGR	Press mount

Receptacles

STRAIGHT PCB RECEPTACLES



Part number	Fig.	Captive center contact	Finish	Assembly instructions	Panel drilling	Packaging	Note
R123 426 003	1	Yes	NPGR	-	P03	100/Bulk	-
R123 427 803	2			M01	-	100/Reel	SMT

PCB RECEPTACLES

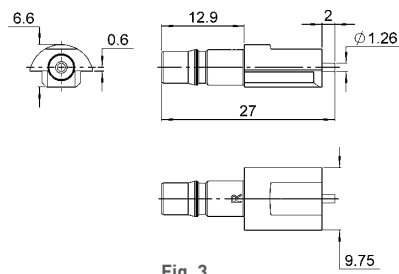
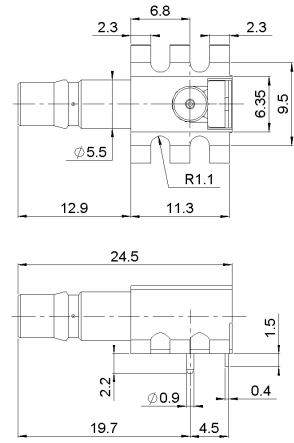
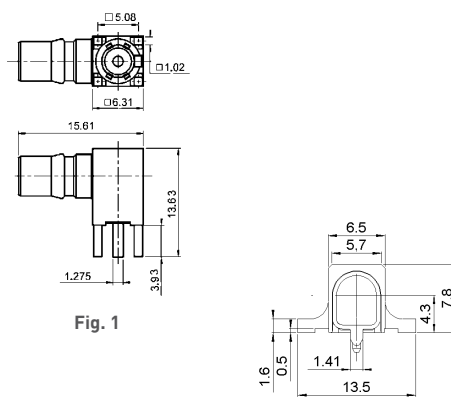

Part number	Fig.	Captive center contact	Finish	Assembly instructions	Panel drilling	Packaging	Note
R123 680 003	1	Yes	NPGR	-	P03	100/Bulk	-
R123 682 827	2			M01	-	100/Reel	Right angle SMT
R123 682 880				-	-	250/Reel	-
R123 444 827	3			-	-	300/Reel	Female edge card

Receptacles

RACK AND PANEL

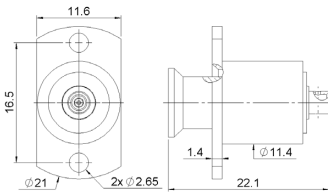

Cable group	Cable group dia.	Part number	Dimensions (mm)	Radial Misalignment	Axial Working Range	Finish	Packaging
			A				
KS1 / RG405	.085 cable	R123 142 000	2.25	Min 1	2.5/4.6	BBR / NPGR	100
KS2 / RG402	.141 cable	R123 141 000	3.65				

Accessories and Adapters

MALE CAPS WITH CORD

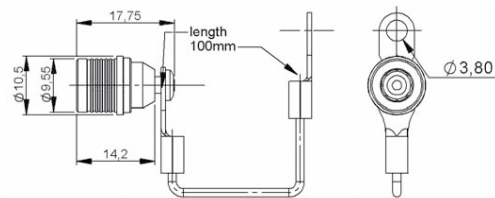

Part number	Finish	Packaging
R123 805 000	BBR	100

IN SERIES ADAPTERS

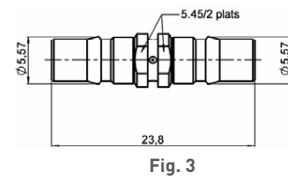
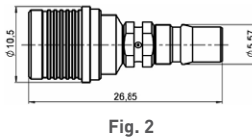
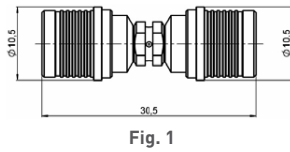

Part number	Fig.	Captive center contact	Finish	Note	Packaging
R123 703 000	1	Yes	BBR	QMA male - QMA male	100 pieces
R123 704 000	2			QMA female - QMA male	
R123 705 000	3			QMA female - QMA female	

BETWEEN SERIES ADAPTERS QMA/SMA

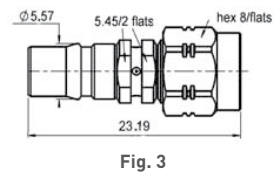
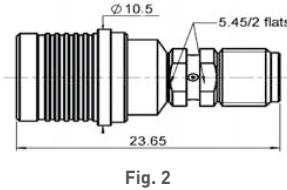
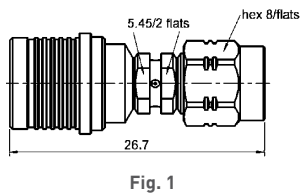

Part number	Fig.	Captive center contact	Finish	Note	Packaging
R191 910 000	1	Yes	BBR	QMA male - SMA male	Unit
R191 911 000	2			QMA male - SMA female	
R191 912 000	3			QMA female - SMA male	
R191 913 000	4			QMA female - SMA female	

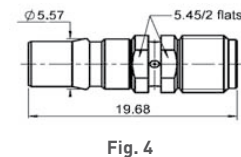

Adapters

BETWEEN SERIES ADAPTERS QMA / N

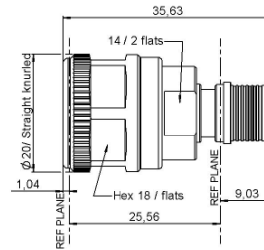
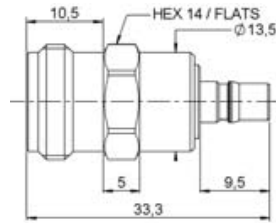
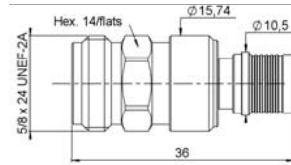
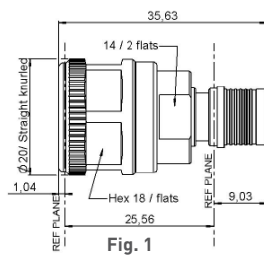

Part number	Fig.	Finish	Note	Packaging
R191 762 000	1	BBR	QMA female - N male	1 Unit
R191 763 000	2		QMA male - N female	
R191 764 000	3		QMA female - N female	
R191 765 000	4		QMA male - N male	

Panel Drilling

P01

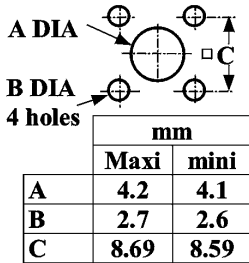

P02

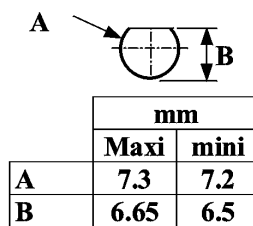

P03

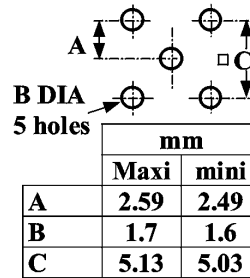

P04

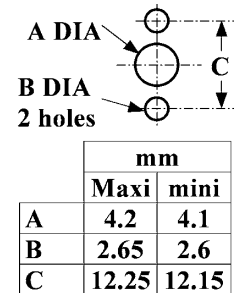

P05

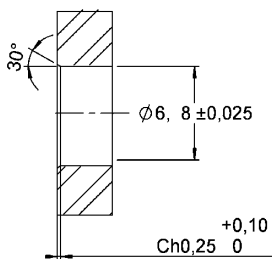

QMA Receptacle Packaging

TAPE AND REEL

ACCORDING TO IEC
286-3 STANDARD

MATERIALS

Reel: polyester

Carrier tape: antistatic PETG (polyester)

Cover tape: polyester

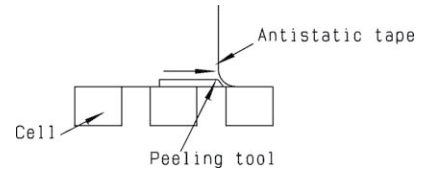
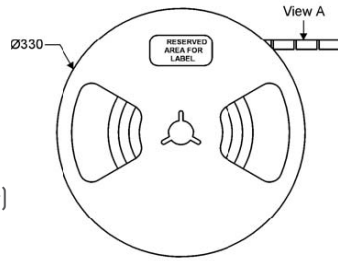

View A

Part number
R123 427 803

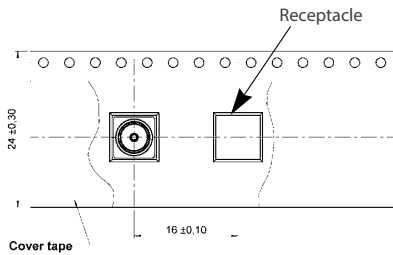

Part number
R123 682 827

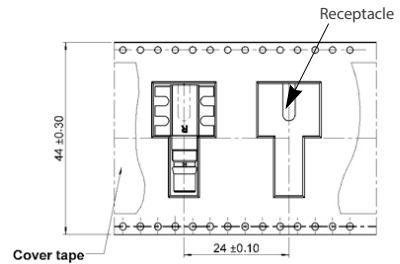

Assembly Instructions

M01

Receptacle soldering pattern

Part number
R123 427 803

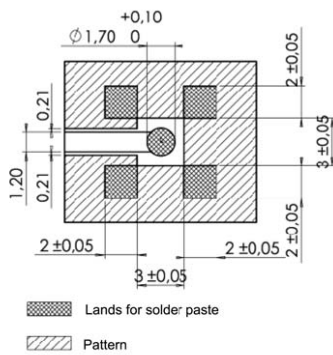

Part number
R123 682 827

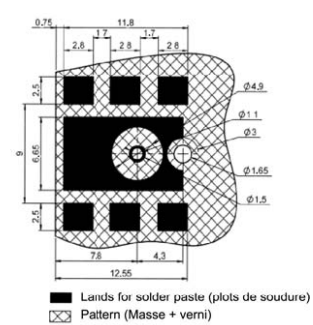

▨ Lands for solder paste
▨ Pattern

■ Lands for solder paste (plots de soudure)
▨ Pattern (Masse + verni)

COPLANAR LINE: Pattern and signal are on the same side. Thickness of PCB = 1.6 mm. The material of PCB is the glass epoxy resin (Er = 4.8). The solder paste should be printed except for the land pattern on the PCB.

Video shadow

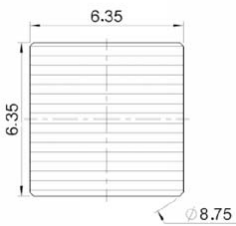

Vacuum nozzle dimensions:

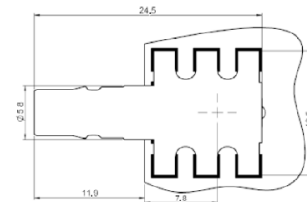
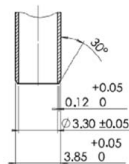

Plugs, Jacks and Receptacles

STRAIGHT PLUGS

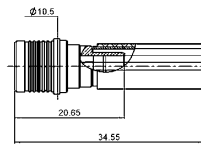

Fig. 1

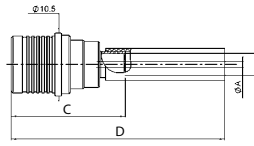

Fig. 2

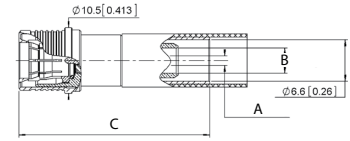

Fig. 3

Cable group	Cable group dia.	Part number	Fig.	Dimensions				Finish	Ingress protection	Note	Packaging
				A	B	C	D				
ECO 230	6/50/D	R123W 096 100	1	-	-	-	-	BBR	IP68	Crimp type	100 pieces
Hand formable / RG405	.085"	R123W 054 000	2	0.6	2.275	-	-			Solder type	
Hand formable / RG402	.141"	R123W 055 000		1.0	3.70	-	-			Crimp type	
AEP-240FR	LMR® 240	R123W 076 310	3	1.5	4.05	30.5	-				

RIGHT ANGLE PLUGS

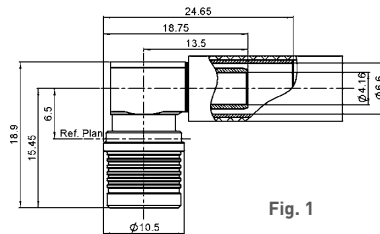

Fig. 1

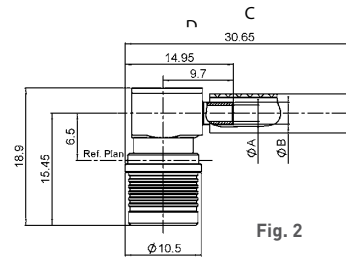
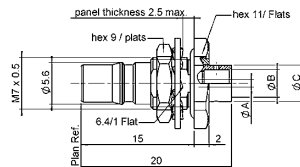

Fig. 2

For assembling, tool **R282 761 000** is recommended

Cable group	Cable group dia.	Part number	Fig.	Dimensions				Finish	Ingress protection	Note	Packaging
				A	B	C	D				
ECO 230	6/50/D	R123W 176 000	1	26.3	3.11	-	-	BBR	IP68	Crimp type	100 pieces
Hand formable / RG405	.085"	R123W 153 000	2	2.275	3.05	-	-			Solder type	
Hand formable / RG402	.141"	R123W 154 000		3.70	4.40	-	-			Crimp type	
AEP-240FR	LMR® 240	R123W 177 110		4.05	6.6	24.65	18.75				

STRAIGHT BULKHEAD JACKS SOLDER TYPE (panel seal)



Cable group	Cable group dia.	Part number	Dimensions			Finish	Ingress protection	Packaging
			A	B	C			
Hand formable / RG405	.085"	R123 326 003	0.60	2.275	3.05	Gold	IP67	100 pieces
Hand formable / RG402	.141"	R123 305 023	1.00	3.70	4.80			

RECEPTACLES (panel seal)

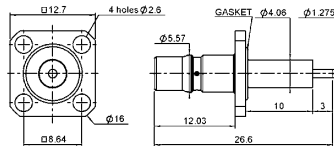

Part number	Finish	Ingress protection	Note	Packaging
R123 425 100	BBR	IP67	Square flange	100 pieces

MALE WATERPROOF PROTECTIVE CAP

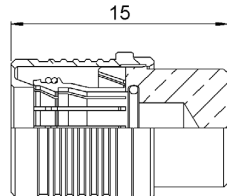
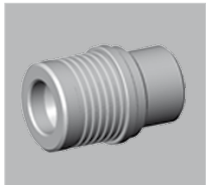

Fig. 1

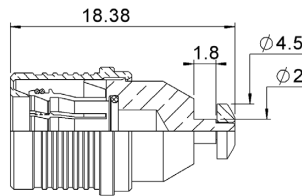

Fig. 2

Part number	Fig.	Finish	Sealing	Packaging
R123W 805 700	1	BBR	IP68	100
R123W 805 710	2			

Characteristics

Test / Characteristics	Values / Remarks
------------------------	------------------

ELECTRICAL CHARACTERISTICS

Impedance	50Ω						
Frequency range	DC - 6 GHz (optimized) DC - 11 GHz (working range)						
Return loss typical <ul style="list-style-type: none"> DC - 3 GHz 3 GHz - 6 GHz 	<ul style="list-style-type: none"> ≥ 32 dB / 1.05 ≥ 25 dB / 1.12 						
Intermodulation	Better - 155 dBc (2 x 43 dBm)						
RF Leakage	100 MHz to 3 GHz better than - 90 dB 3 to 6 GHz better than - 80 dB						
Dielectric withstanding voltage in VRMS (interface) <ul style="list-style-type: none"> At sea level, 50 Hz 	2500						
Working voltage in VRMS (interface) <ul style="list-style-type: none"> At sea level, 50 Hz 	≤ 1000						
Insulation resistance	≤ 5.10 ³ MΩ						
Contact resistance <ul style="list-style-type: none"> Initial After test 	<table border="0"> <tr> <td>Center contact</td> <td>Outer contact</td> </tr> <tr> <td>≤ 1 mΩ</td> <td>≤ 0.25 mΩ</td> </tr> <tr> <td>≤ 1.5 mΩ</td> <td>≤ 1 mΩ</td> </tr> </table>	Center contact	Outer contact	≤ 1 mΩ	≤ 0.25 mΩ	≤ 1.5 mΩ	≤ 1 mΩ
Center contact	Outer contact						
≤ 1 mΩ	≤ 0.25 mΩ						
≤ 1.5 mΩ	≤ 1 mΩ						

MECHANICAL CHARACTERISTICS

Durability matings	≥ 100
Force to engage and disengage <ul style="list-style-type: none"> Typical 	40 N
Retention force for interface	≥ 450 N (101.25 Lbs)
Bending moment admissible interface	≤ 10 Nm
Contact captivation <ul style="list-style-type: none"> Cable connectors Receptacles 	<ul style="list-style-type: none"> ≥ 28 N ≥ 18 N

ENVIRONMENTAL CHARACTERISTICS

Temperature range	- 55°C + 125°C
Climatic category	40 / 125 / 21 (IEC 60169 1 16.2)
Shock	MIL STD 202F, method 213, condition I
Rapid change of temperature	IEC 60169-1 16.4 (-40°C + 125°C)
Corrosion salt spray	Test acc. to MIL STD 202F, method 101D, condition B
Vibration	IEC 1169-1 paragraph 9.3.3 (10-500 Hz; 5g)
Moisture resistance	MIL STD 202 F, method 106F
Water resistance	IP 68

MATERIALS AND PLATING

	Material	Plating
Body	Brass	BBR over Silver
Center contact	Brass / Beryllium copper	Silver passivated over copper
Outer contact	Beryllium copper	BBR over Silver
Insulator	PTFE	
Others parts	Brass	BBR

All dimensions are given in mm.

Characteristics

POWER RANGE

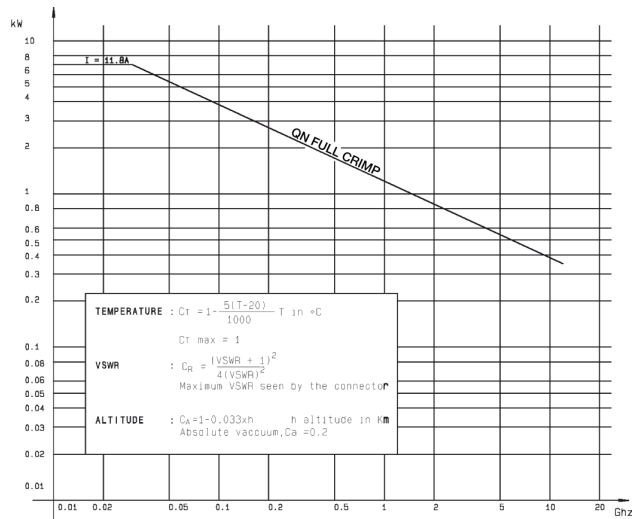

Plugs

STRAIGHT PLUGS, FULL CRIMP TYPE, FOR FLEXIBLE CABLES

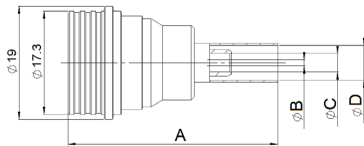

Fig. 1

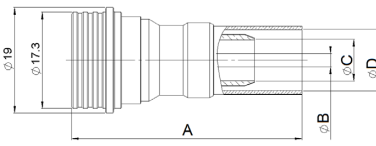
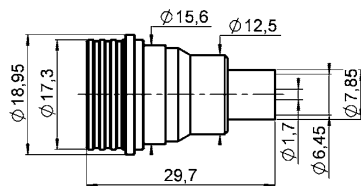

Fig. 2

Cable group	Cable group dia.	Part number	Fig.	Dimensions (mm)				Captive center contact	Packaging
				A	B	C	D		
RG58 / RG141	5/50/S	R164 075 000	1	35.2	1.05	3.1	5.4	No	50 pieces
RG142 / RG223 / RG400	5/50/D	R164 076 000					5.8		
RG213	10/50/S	R164 080 000	2	41.5	2.45	7.5	11.05	Yes	Unit
AEP-240FR	LMR® 240	R164 075 010	1	35.2	1.5	4.05	6.6		50
AEP-400FR	LMR® 400	R164 080 020	2	41.5	2.82	7.46	11.05	No	Unit
AEP-600FR	LMR® 600	R164 080 030							44.5

STRAIGHT PLUGS, SOLDER TYPE, FOR SEMI-RIGID CABLES



Cable group	Cable group dia.	Part number	Captive center contact	Packaging
RG401	.250"	R164 054 002	No	50 pieces

Plugs and Jacks

RIGHT ANGLE PLUGS

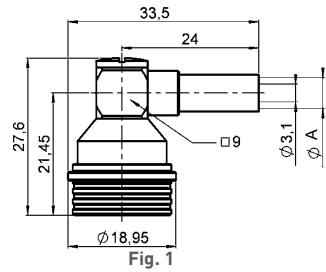

Fig. 1

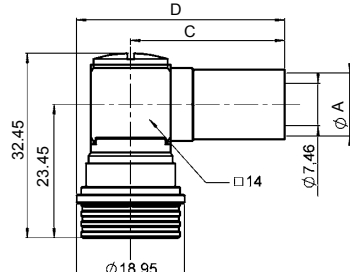

Fig. 2

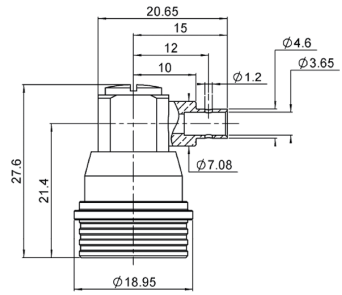

Fig. 3

Cable group	Cable group dia.	Part number	Fig.	Dimensions (mm)			Captive center contact	Packaging	Note
				A	C	D			
RG402	.141"	R164 152 100	3						Solder type
RG58 / RG141	5/50/S	R164 175 000	1	5.41	-	-	Yes	50 pieces	Crimp type
RG142 / RG223 / RG400	5/50/D	R164 176 000		5.8	-	-			
RG213	10/50/S	R164 184 000	2	11.05	27	36.5			
AEP-240FR	LMR® 240	R164 185 007							

STRAIGHT JACKS

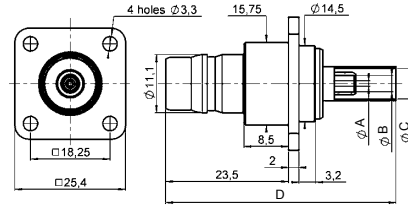

Fig. 1

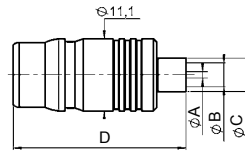

Fig. 2

Cable group	Cable group dia.	Part number	Fig.	Dimensions (mm)				Captive center contact	Packaging	Note
				A	B	C	D			
RG213	10/50/S	R164 286 000	1	2.45	7.46	11.05	46.1	No	50 pieces	25.4 mm square flange crimp type
RG402	.141"	R164 336 000	2	0.97	3.68	5.18	26.6	Yes		Solder type

Jacks and Receptacles

BULKHEAD STRAIGHT JACKS (panel seal)

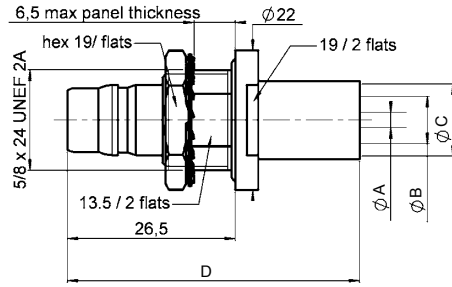

Fig. 1

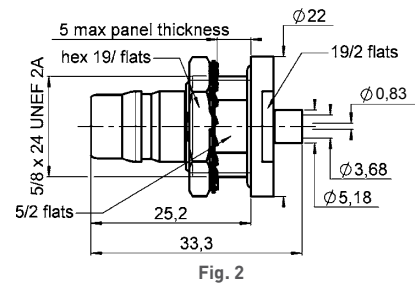
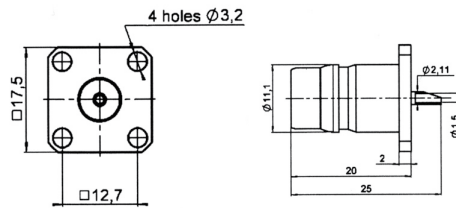
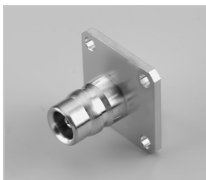

Fig. 2

Cable group	Cable group dia.	Part number	Fig.	Dimensions (mm)				Captive center contact	Panel drilling	Packaging	Note
				A	B	C	D				
RG142 / RG223 / RG400	5/50/D	R164 329 200	1	1.05	3.11	5.8	44.1	No	P03	50 pieces	Rear mount Full crimp type
RG402	.141"	R164 635 002	2	-	-	-	-	Yes			Rear mount Solder type
AEP-400FR	LMR® 400	R164 241 020	3	46.1	2.82	7.46	11.05	-	-	-	Crimp type

SQUARE FLANGE, STRAIGHT FEMALE RECEPTACLE



Part number	Captive center contact	Panel drilling	Packaging	Note
R164 418 000	Yes	P01	50 pieces	Solder pot 17.5 square flange

RECEPTACLES

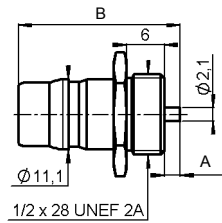

Fig. 1

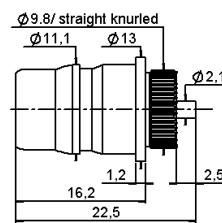
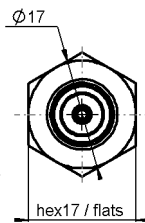

Fig. 2

Part number	Fig.	Dimensions (mm)		Captive center contact	Panel drilling	Packaging	Note
		A	B				
R164 571 027	1	2.5	25.5	Yes	-	50 pieces	Screw-on front mounting
R164 540 027	2	-	-		P02		Press-in

Receptacles and Adapters

WATERPROOF RECEPTACLES

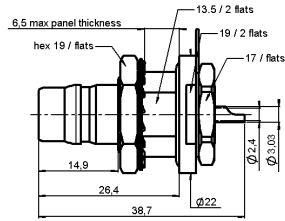

Fig. 1

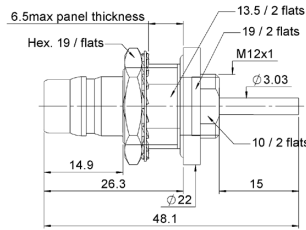

Fig. 2

Part number	Fig.	Captive center contact	Panel drilling	Packaging	Note
R164 606 000	1	Yes	P03	50 pieces	IP68
R164 606 020	2				

IN SERIES ADAPTERS

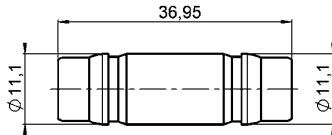

Fig. 1

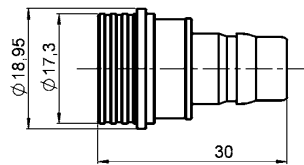

Fig. 2

Part number	Fig.	Captive center contact	Packaging	Note
R164 705 000	1	Yes	50 pieces	QN female - QN female
R164 708 000	2			QN male - QN female

BETWEEN SERIES ADAPTERS QN/N

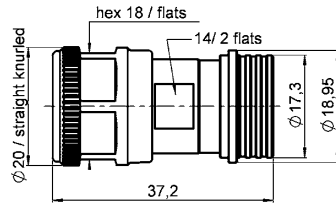

Fig. 1

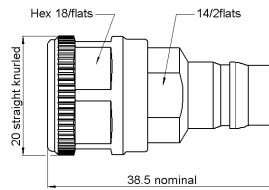

Fig. 2

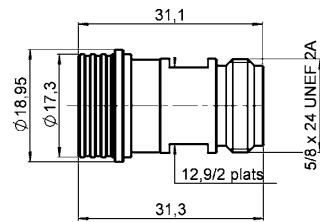

Fig. 3

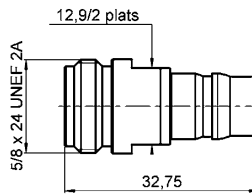
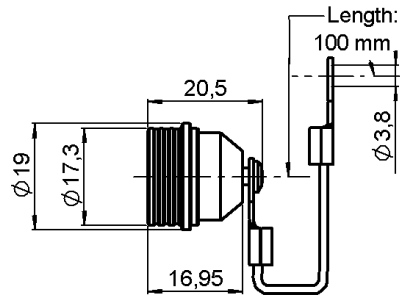

Fig. 4

Part number	Fig.	Captive center contact	Packaging	Note
R191 757 000	1	Yes	Unit	QN male - N male
R191 758 000	2			QN female - N male
R191 759 000	3			QN male - N female
R191 760 000	4			QN female - N female

Protective CAP

PROTECTIVE CAP



Part number	Designation
R164 804 000	Male

Panel Drilling

P01

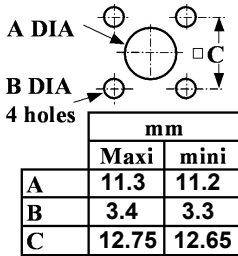

P02

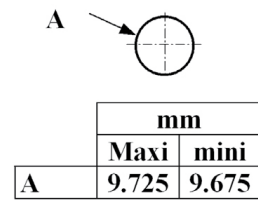

P03

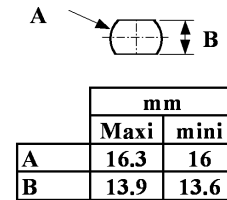

Introduction

QRE™ is a Quick Lock Ruggedized connector. QRE™ was developed to provide the same advantages as QMA over SMA and designed more for aerospace and defense applications.

QRE™ is made of high grade stainless steel 316L, with Teflon coated fluoro-silicone sealing o-rings which make the QRE™ interface waterproof and ultra resistant to chemical aggression and corrosion. The outer slotted spring contact inspired from the QMA design was reinforced to provide reliable electrical contact during vibration and shock conditions. All QRE™ material were chosen and optimized to operate within the extended temperature range typical in Mil-Aerospace applications. Its superior latching mechanism provides the advantage of a snap-on connector while ensuring a very robust and secure connection. The retention force of the interface is 3 times higher than the QMA. With similar dimensions, QRE™ offers high density integration capabilities like QMA. In addition, a specific tool has been designed to easily disconnect QRE™ plugs on high density applications such as active array radar modules or panels.

A limited range of straight and right angle connectors and receptacles is available for semi-rigid and SHF high frequency flexible cable. New connectors can be quickly developed to fit your own ruggedized coaxial cable. QRE™ cable assemblies can be delivered using our SHF airframe, lightweight or outdoor cables, with or without antiabrasion jacket. Adapters are available for test and measurement in QRE™ to SMA and QRE™ to SMA 3.5 configurations.

Characteristics

Test / Characteristics	Values / Remarks
ELECTRICAL CHARACTERISTICS	
Impedance	50Ω
Frequency range	DC - 12.4 GHz
V.S.W.R. typical	
• DC - 3 GHz	1.06
• 3 GHz - 6 GHz	1.11
• 6 GHz - 12.4 GHz	1.17
Max insertion loss	0.25
Insulation resistance	5000 MΩ min
Voltage rating	335 Veff max
Dielectric withstanding voltage	1000 Veff min
Admissible power (CW)	450 W @ 1 GHz - 100 W @ 18 GHz
RF leakage	-95 dB min @ 3 GHz -80 dB min @ 12.4 GHz

MECHANICAL CHARACTERISTICS

Durability	100 matings (500 matings option is available)
Engagement and disengagement forces	65 N typ
Retention force for interface	150 N min
Minimum connector pitch	12.4 mm (distance between center conductors)
Vibration	MIL STD 202 method 204 condition D
Shock	MIL STD 202 method 213 condition I

ENVIRONMENTAL CHARACTERISTICS

Temperature range	-55/+165°C
IP rating (when mated)	IP 68
Hermeticity (when mated)	10 ⁻⁶ atm.cm ³ /s (CEI 68-2-17 Method Qk)

MATERIALS AND PLATING

	Material	Plating
Connector bodies	Stainless steel 316L	Passivated
Center contacts	Beryllium copper	Gold over Nickel
Outer contact	Beryllium copper	NPGR
Insulators	PTFE	-
O-rings	Fluorosilicone	-

All dimensions are given in mm.

Plugs, Jacks and Receptacle

STRAIGHT AND RIGHT ANGLE PLUGS, SOLDER TYPE

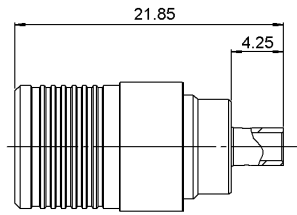

Fig. 1

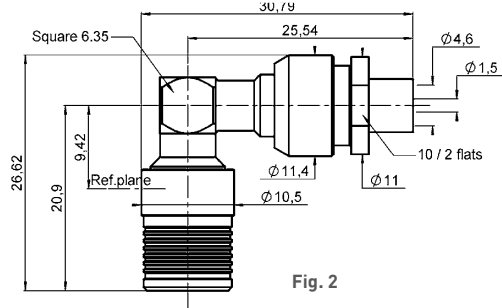

Fig. 2

Cable group	Cable group dia.	Part number	Fig.	Captive center contact	Finish
RG 405	.085"	R324 054 L01	1	No	Passivated
RG 402	.141"	R324 055 L00			
SHF5MAF	Special	R324 195 L02	2		

Note:

For other semi-rigid or flexible cables, please contact us.

STRAIGHT FLANGE JACK SOLDER TYPE FOR SEMI-RIGID CABLE

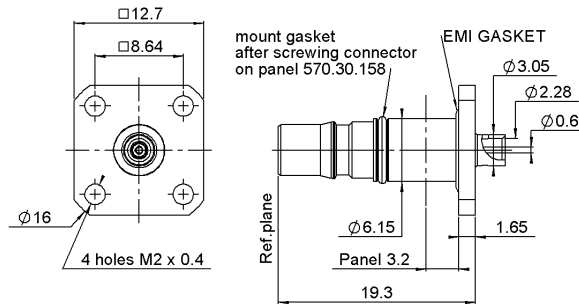
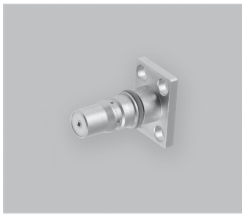

Cable group	Cable group dia.	Part number	Captive center contact	Panel drilling	Finish
RG 405	.085"	R324 256 L01	Yes	P01	Passivated

STRAIGHT FLANGE FEMALE RECEPTACLE

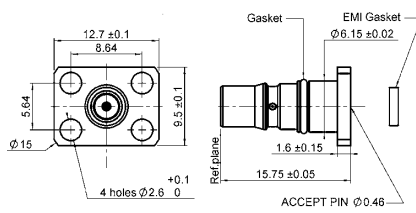

Fig. 1

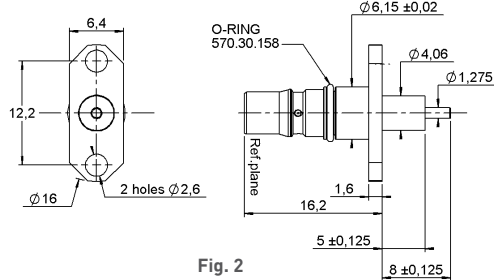

Fig. 2

Part number	Fig.	Captive center contact	Panel drilling	Finish	Note
R324 434 L01	1	Yes	P02	Passivated	EMI Gasket
R324 474 L00	2		P03		-

NOTE:

Replacement O-rings and EMI gaskets available to order, please contact us.

Adapters and Extraction Tool

HERMETIC SCREW-IN FEMALE RECEPTACLE

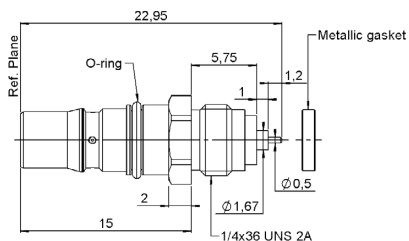

Part number	Captive center contact	Panel drilling	Finish	Note
R324 555 L01	Yes	P04	Passivated	Metallic gasket

BETWEEN SERIES ADAPTERS QRE/SMA

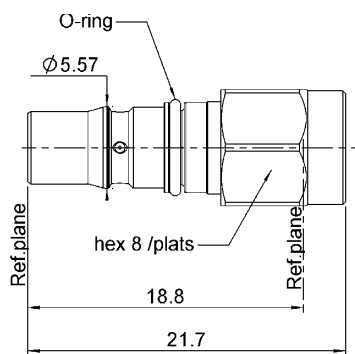
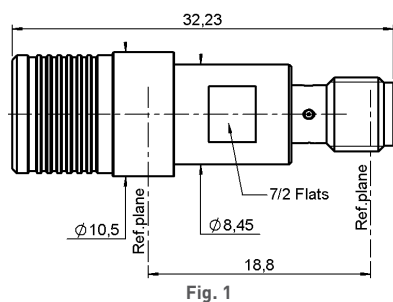

Part number	Fig.	Captive center contact	Finish	Note
R191 926 L01	1	Yes	Passivated	QRE™ male – SMA female
R191 927 L01	2			QRE™ female – SMA male

Note:
For QRE™ to SMA 3.5 adapters, please contact us.

QRE™ EXTRACTION TOOL

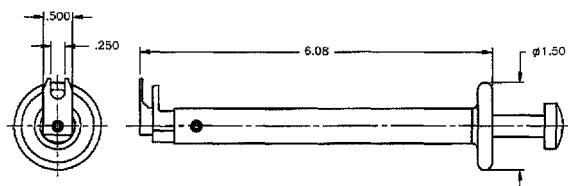

Part number
TA-0457

This tool can be used with either straight or right angle connectors.

Panel Drilling

P01

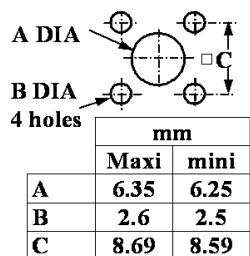

P02

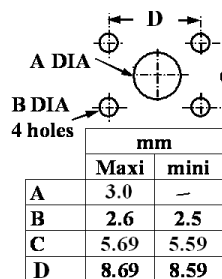

P03

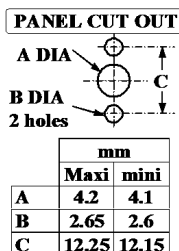

P04



NOTE

