



## MISCELLANEOUS: BR2/TYPE 43/UHF/IMP/UMP

*R605/R214/R155/R107*

**Contents****TYPE 43**

Introduction.....	14-4
Interface .....	14-4
Characteristics .....	14-5
Panel drilling .....	14-8

**STANDARD DENSITY**

Plugs .....	14-6
Sockets.....	14-6
Receptacles.....	14-6

**HIGH DENSITY**

Plugs .....	14-7
U links.....	14-8

**ULTRA HIGH DENSITY**

Plugs .....	14-7
-------------	------

**IMP**

Introduction.....	14-9 to 14-10
Characteristics.....	14-11
Board to board connectors .....	14-12
Receptacle packaging.....	14-13
Assembly instructions .....	14-12

**UMP**

Characteristics.....	14-11
Receptacles.....	14-14
Pigtails .....	14-14
Cable assemblies.....	14-14
Tools and accessories.....	14-15
Assembly instructions .....	14-16

**BR2**

Interface .....	14-17
Characteristics.....	14-17
Plugs .....	14-18
Jacks .....	14-18
Receptacles.....	14-19
Caps .....	14-19
Gasket .....	14-20
Panel drilling .....	14-20

**UHF**

Interface .....	14-21
Characteristics.....	14-21
Plugs .....	14-22
Receptacles.....	14-22
Adapter.....	14-22

## Introduction

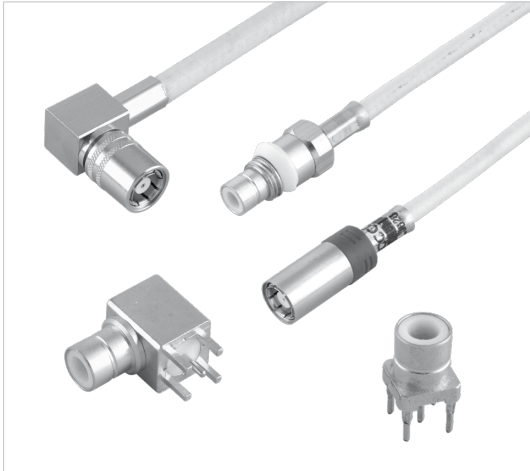

75Ω	DC - 3 GHz
-----	------------

### GENERAL

- Standard coaxial connectors
- Reliable lock coupling
- 3 types: Standard Density (12.7mm)  
High Density (10mm)  
Ultra High Density (9mm)

### APPLICABLE STANDARDS

- BS9210 F0022

### APPLICATIONS

- Telecom DDF (Digital Distribution Frames)

## Interface

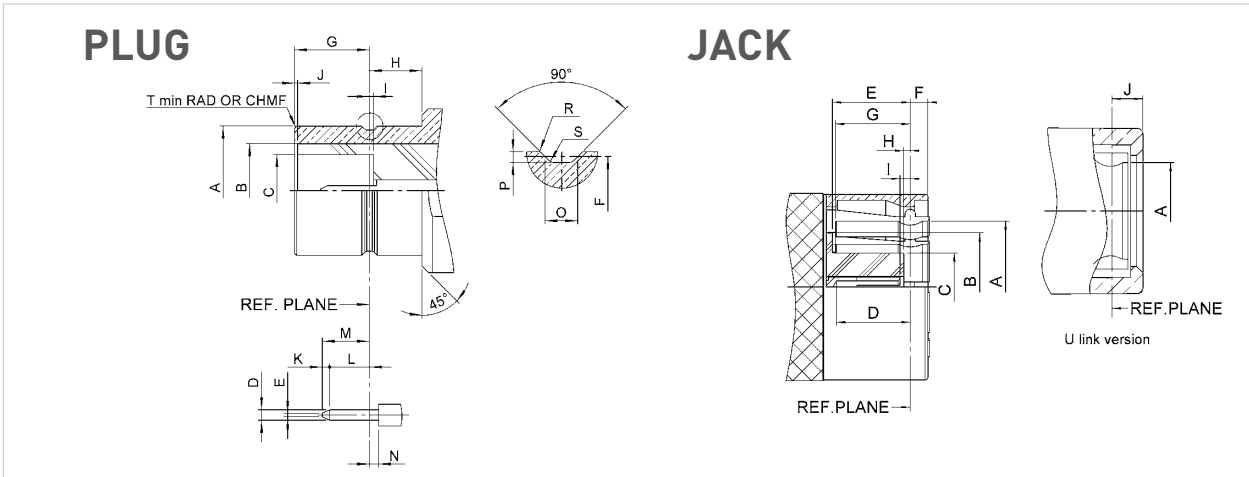

Letter	mm		inch	
	min.	max.	min.	max.
A DIA	6.20	6.23	.244	.245
B DIA	5.25 NOM		.207 NOM	
C DIA	3.4	3.475	.134	.137
D DIA	0.48	0.52	.019	.02
E DIA	0.125	0.225	.005	.009
F DIA	5.97	6.02	.235	.237
G	3.5	3.55	.138	.14
H	2.4	2.55	.095	.1
I	0.05	0.175	.002	.007
J	0.00	0.10	0.00	.004
K	0.25	0.35	.01	.014
L	1.35	-	.053	-
M	-	2.05	-	.081
N	-	0.18	-	.007
O	0.58 NOM		.023 NOM	
P	0.15	0.25	.006	.01
R	0.05	0.15	.002	.006
S	-	0.13	-	.005
T	0.1	0.2	.004	.008

Letter	mm		inch	
	min.	max.	min.	max.
A DIA	6.31	6.36	.248	.25
B DIA	5.25 NOM		.207 NOM	
C DIA	3.22	3.30	.127	.13
D	3.2	3.53	.126	.139
E	3.63	3.83	.143	.151
F	-	1.8	-	.071
G	3.61	3.77	.142	.148
H	0.23	0.38	.009	.015
I	0.23	0.48	.009	.019
J	1.475	1.97	.058	.078

## Characteristics

## TYPE 43 GENERAL TECHNICAL SPECIFICATION

Radiall 75Ω coaxial Type 43 connectors are designed to meet or exceed the requirements of BS9210 F0022. The following information is subject to change without notice. The performance values shown are typical and may not relate to all connector styles available.

Test / Characteristics	Values / Remarks
------------------------	------------------

## ELECTRICAL CHARACTERISTICS

Impedance	75Ω
Frequency range	DC - 3 GHz
Temperature range	-40°C to + 100°C
V.S.W.R. (Straight Connectors)	1.20 max
V.S.W.R. (Right Angle Connectors)	1.25 max
Voltage Rating	500 Vrms max
Dielectric Withstanding Voltage	1500 Vrms min
Insulation resistance	5000 MΩ min

## MECHANICAL CHARACTERISTICS

Durability	250 matings
Cable retention (Plug connectors) (Socket connectors)	60 to 220 N min***
Center contact retention (Plug connectors) (Socket connectors)	22 N min
Weight	10 g (grams) typical

## MATERIALS AND PLATING

Components	Materials	Platings
Body Components*	Brass	Selective Gold
Outer contact	Bronze	Selective Gold
Center contact (male)	Brass	Gold
Center contact (female)	Beryllium Copper	Gold
Insulator	PTFE	N/A
Panel Grommet	Polyacetal	N/A
Ferrule	Brass	Nickel
Panel Mounting Hardware**	Brass or Phosphor Bronze	Nickel

\* In general all Type 43 series connector bodies are gold plated in mating areas.

As a note, the single piece Type 43 connector body is gold plated in the mating area with other surfaces being nickel coated. All multi-piece connector bodies comprise of a gold plated front body (mating area) and a nickel plated back body (crimp area).

\*\* Panel mounting hardware includes components such as - nut, washer, spacer etc.

\*\*\* Note, **lower cable retention value** for RG179 - 60 N min and BT3002/TZC 75024 - 150 N min

Plugs, Sockets and Receptacles - Standard Density

**STRAIGHT SOCKETS CRIMP TYPE FOR FLEXIBLE CABLES**

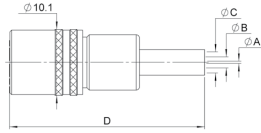

Cable group	Cable group dia.	BT Reference	Part number	Dimensions				Packaging
				A	B	C	D	
BT3002	3.6/75/D	S 43/5 FS	R214 083 922	0.36		4.47	3.2	20 pieces

**STRAIGHT BULKHEAD RECEPTACLE WITH SOLDER POT**

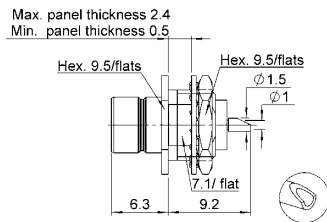

Part number	Panel drilling	Packaging
R214 553 000	P02	Unit

**STRAIGHT PCB PLUG RECEPTACLES**

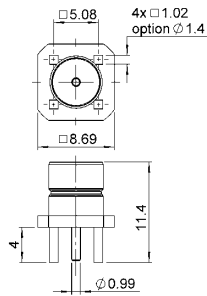

BT Reference	Part number	Panel drilling	Packaging
P 43 / 1 D	R214 426 704	P01	100 pieces

Plugs - High Density, Sockets and Ultra High Density

**STRAIGHT PLUGS CRIMP TYPE FOR FLEXIBLE CABLES**

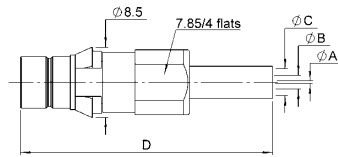

Cable group	Cable group dia.	BT Reference	Part number	Dimensions				Panel drilling	Packaging
				A	B	C	D		
RG179	2.6/75/S	HDC 43/4 GTIS	R214 318 702	0.38	1.73	3.25	35	P03	20 pieces
BT3002	3.6/75/D	HDC 43/5 GTIS	R214 318 722	0.36	2.10	4.47			
RA7000	4.5/75/D	HDC 43/7 GTIS	R214 325 742	0.69	3.00	5.48			

**STRAIGHT SOCKETS CRIMP TYPE FOR FLEXIBLE CABLES**

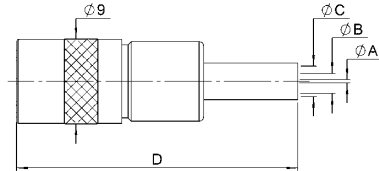

Cable group	Cable group dia.	BT Reference	Part number	Dimensions				Packaging
				A	B	C	D	
RG179	2.6/75/S	HDC 43/4FS	R214 088 902	0.38	1.73	3.25	32	20 pieces
BT3002	3.6/75/D	HDC 43/5FS	R214 088 922	0.35	2.10	4.47	30	

**STRAIGHT PLUG CRIMP TYPE FOR FLEXIBLE CABLES**

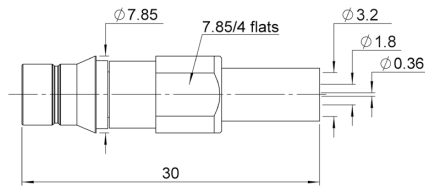

Fig. 1

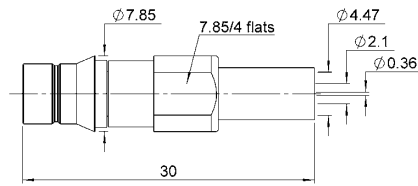

Fig. 2

Cable group	Cable group dia.	BT Reference	Part number	Fig.	Panel drilling	Packaging
RG179	2.6/75/S	UHDC 43/4 GTIS	R214 320 702	1	P04	20 pieces
BT3002	3.6/75/D	UHDC 43/5 GTIS	R214 320 722	2		

U Links - High Density

U LINKS

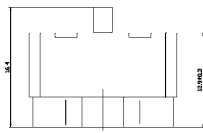

Fig. 1

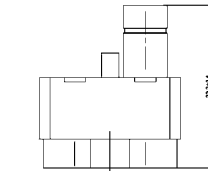

Fig. 2

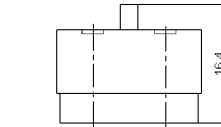

Fig. 3

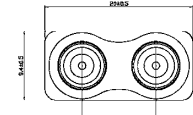
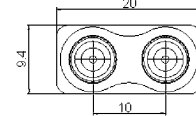

Fig. 4

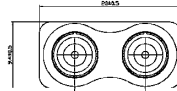

Fig. 5

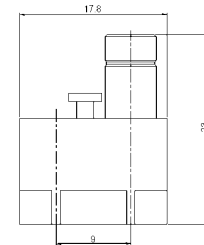
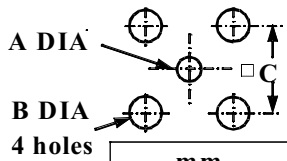

Fig. 6

BT Reference	Part number	Fig.	Packaging
U link 10A	R214 797 703	1	50 pieces
U link 10B	R214 798 703	2	
U link 13A	R214 790 703	3	
U link 13B	R214 791 703	4	
U link 9A	R214 797 723	5	
U link 9B	R214 798 723	6	

Panel Drilling

PO1



	mm	
	Maxi	mini
A	1.5	1.2
B	2.0	1.7
C	5.1	5.06

PO2

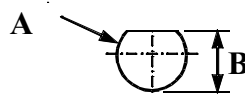

	mm	
	Maxi	mini
A	8.04	7.94
B	7.5	7.4

PO3

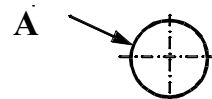

	mm	
	Maxi	mini
A	7.55	7.5

PO4



	mm	
	Maxi	mini
A	7.35	7.05

**Introduction**

Radiall introduced the MMP contact technology (Micro Miniature Pressure) in 2001 to meet the needs of the telecommunication industry for ultra low profile and cost effective board connectors. The MMP technology can be found in 2 product lines:

- **IMP** series: RF Board-to-Board application
- **UMP** series: RF board to wire application

**BOARD-TO-BOARD APPLICATION**



IMP

**BOARD TO WIRE APPLICATION**

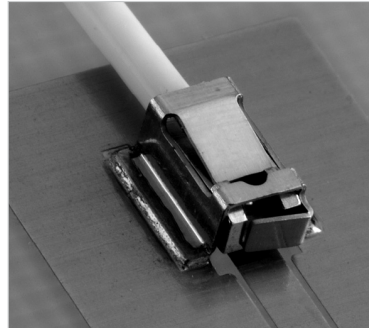

UMP

The **IMP** series (Interconnect Micro miniature Pressure contact) consists of 1 coaxial connector when usually the same application requires either 2 coaxial connectors (a male SMT receptacle and a female SMT receptacle), or 3 coaxial connectors (2 SMT receptacles and an adapter).

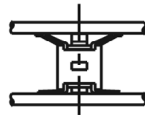

**IMP**  
One piece connector

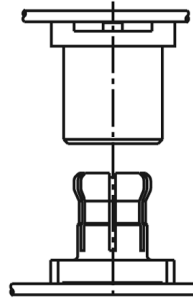

**MCX**  
2 coaxial connectors

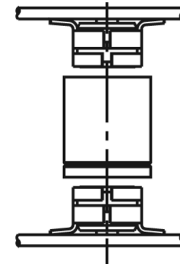

**MMS**  
3 coaxial connectors

The **UMP** series (Ultra Miniature Pressure contact) consists of 1 coaxial plug and 1 SMT edge receptacle.

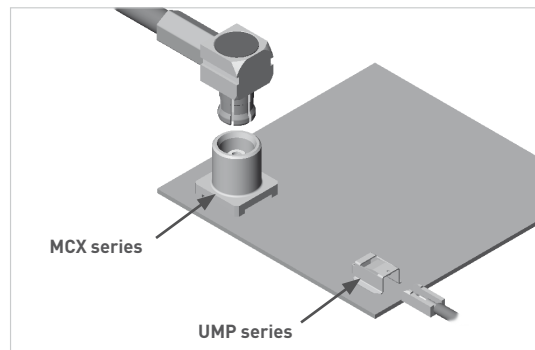



**Introduction**

**IMP PRODUCT FEATURES**

- Cost effective solution: one piece connector only
- High density
- Lightweight connector: (example 0.02 g for the IMP 2 mm)
- Low profile for a board-to-board coaxial connections (2 mm)

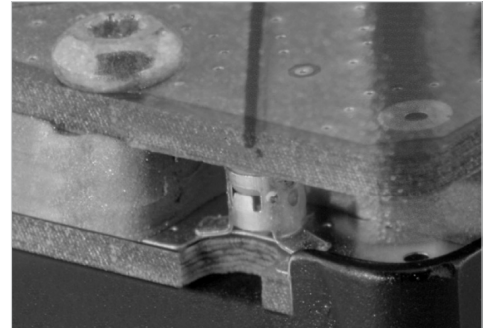

**IMP INSTALLATION**

The distance between the 2 boards should be precisely measured by a mechanical device (such as spacers).

Contact **Radiall** for support regarding the layout in your particular application. Application notes are available upon request.

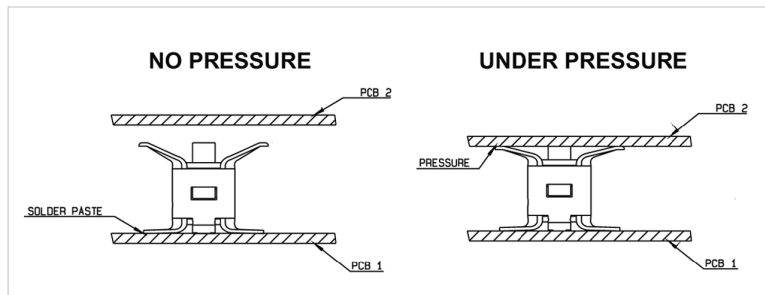

**IMP PRODUCT RANGE**

IMP is available in 2 mm board-to-board distance. Other heights can be developed upon request.

**UMP PRODUCT FEATURES**

- Low profile: 2 mm and 3 mm
- Small space for connection: needs only 2 mm of height
- Cost effective solution: 1 coax connector only
- Large cable range from 0.8 to 2.6 mm
- High durability, up to 10,000 cycles

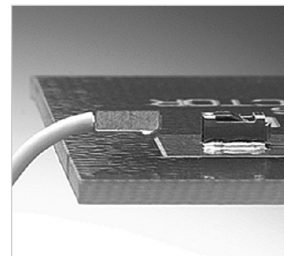

**UMP TYPE OF MATING:**

- Lock: - Can only be disconnected using a tool  
- Number of matings 100  
- Withstands severe vibrations
- Snap-on: - Number of matings 3000
- Snap-on: - Number of matings 10,000  
- For test applications

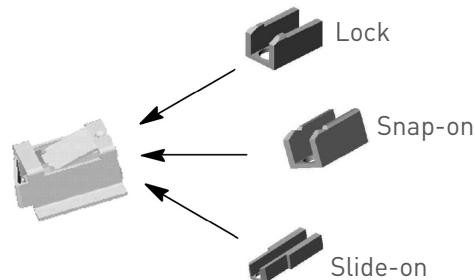

Plug exist with the 3 types of mating:

**APPLICATIONS**

IMP and UMP series can be used for board-to-board and board-to-antenna applications:

- WLAN
- Automotive
- RFID
- GPS receivers
- Handheld radios

## Characteristics

	Values / Remarks	
--	------------------	--

**ELECTRICAL CHARACTERISTICS**

	IMP	UMP
Impedance	50Ω	
Frequency range	DC-6 GHz	
V.S.W.R. Max	1.3	1.05 + 0.03F (mated connectors)
Insertion Loss (dB)	0.2 V F (GHz)	
RF Leakage	-40dB min at 2 GHz	
Insulation resistance	3000MΩ	1000MΩ min
Contact resistance (depending on PC board) • Center contact • Outer contact	60 mΩ 10 mΩ	
Working voltage	100 VRMS	
Dielectric withstanding voltage	350 VRMS	
Power at sea level, at 20°C	20 W (at 3 GHz)	50 W (at 1.8 GHz)

**MECHANICAL CHARACTERISTICS**

Durability	> 20	- Lock: 100 - Snap-on: 3000 - Slide-on: 10,000
Weight (g)	0.02	- Receptacle: 0.03 - Plug: 0.08
Axial misalignment from nominal board to board distance in mm (inch)	±0.2 (.008)	N/A
Radial misalignment in mm (inch)	0.2 (.008)	N/A
Force to engage	-	5N
Cable retention force	-	20N - 100N
Sine vibrations	-	IEC 68-2-6
Random vibrations	-	IEC 68-2-36
Shocks	-	IEC 68-2-29
Retention on test board	-	20N min

**ENVIRONMENTAL CHARACTERISTICS**

Temperature range	-40 / +90°C
-------------------	-------------

**MATERIALS**

Body/outer contact	Beryllium copper	- Plug: Brass - Receptacle: Beryllium copper
Center contact		Brass (plug only)
Insulator	Polyethercetone	PTFE

**PLATING**

Body	Gold
Contact	

Board-to-Board Connectors

SMT CONNECTORS

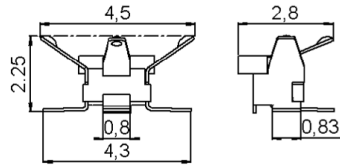

Part number	Height (mm)	Packaging	Reel dimensions A (mm)	Assembly instructions
R107 064 080	2	Reel of 3500	330	M01
R107 064 070		Reel of 100	180	

Assembly Instructions

M01

SOLDERING PATTERN

Part number  
R107 064 080

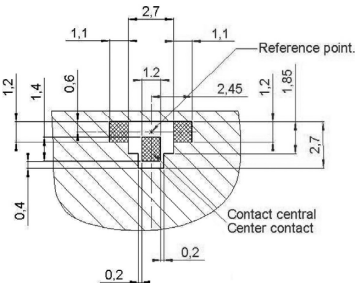

Part number  
R107 064 070  
R107 064 080

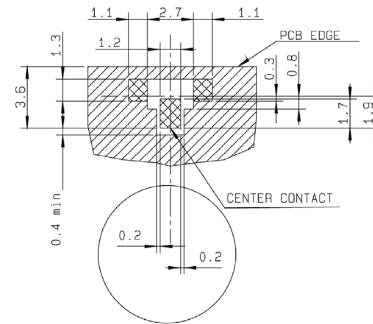

Metallization  
Land for solder paste (area free of varnish)

CONTACT PATTERN

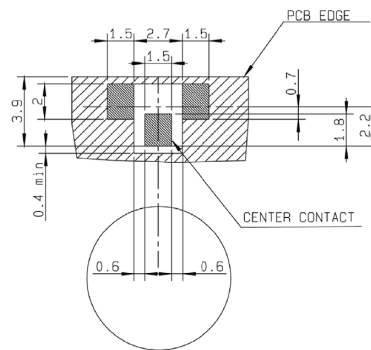
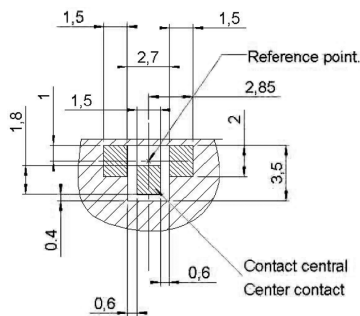

Metallization  
Contact area (area free of any surface contaminant)

## Receptacle Packaging

## PROCEDURE FOR USE OF SMT NOZZLE FOR RECEPTACLE

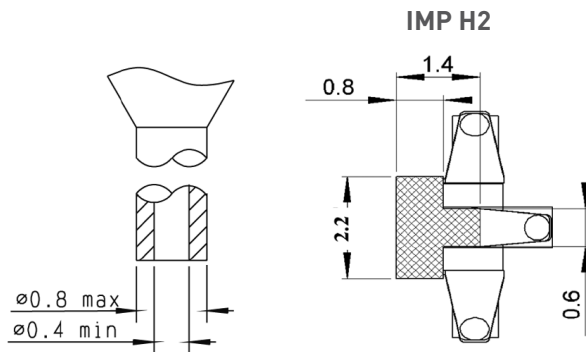

The following pick and place equipment and associated nozzles were successfully tested for the IMP:

- A) FUJI: QP-242/MODULE TYPE  
 QP-242 IMP MOUNT MODULE NAME: TYPE BI-612  
 IMP NOZZLE PART N°: I-S12B-013-100 (NOZZLE PIE 1.3)
- B) PANASONIC: MSF type machine  
 NOZZLE PART N°: 10 807 GH 810

For other equipment, please contact your supplier to define equivalent nozzles.

Receptacles, Pigtails and Cable Assemblies

SMT RECEPTACLES

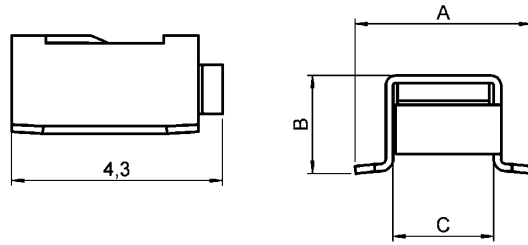
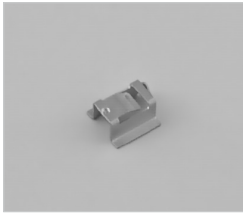

UMP type	Part number	Dimensions (mm)			Finish	Packaging	Reel dimensions (mm)	Assembly instructions
		A	B	C				
H2	R107 003 010	3.6	2	2.05	Gold	100 pieces	180	M02
H3	R107 303 040	5.5	3	2.95				

PIGTAILS

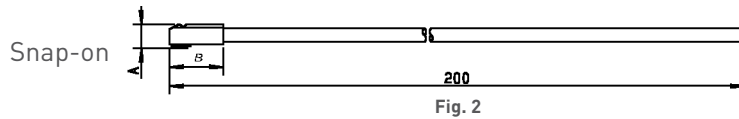
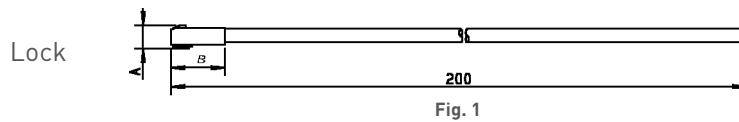
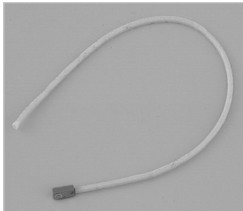

Cable	Cable group	UMP type	Mating type	Part number	Fig.	Dimensions (mm)		Packaging
						A	B	
C291 050 066	1/50/S	H2	Lock	R285 020 202	1	1.74	4	100 pieces
			Snap-on	R285 020 212	2	1.65		
C291 170 017	2.6/50/S	H3	Lock	R285 020 401	1	2.84		

BETWEEN SERIES CABLE ASSEMBLIES

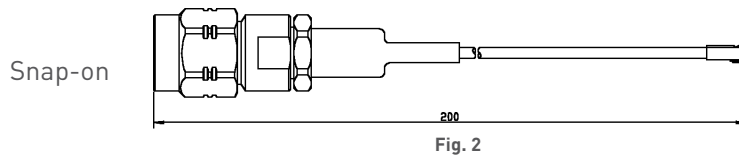
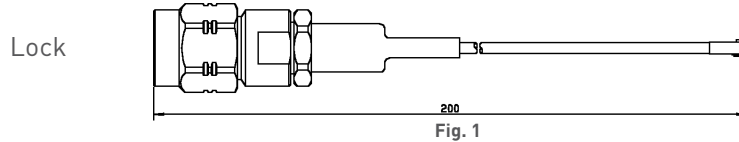

Cable	Cable group	UMP type	Mating type	Part number	Fig.	Series	Packaging
C291 050 066	1/50/S	H2	Lock	R285 025 202	1	UMP/SMA	20 pieces
			Snap-on	R285 025 212	2		
C291 170 017	2.6/50/S	H3	Lock	R285 025 401	1		

Tools and Accessories

**PRODUCTION LINE TEST ADAPTER: UMP - SMA FEMALE**  
(to be used with lock and snap pigtails only)

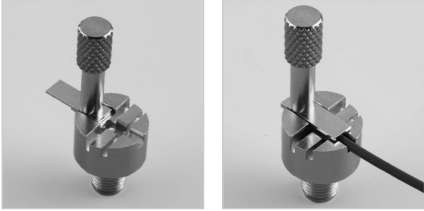

Part number	Connector height (mm)	Packaging
R107 009 901	H 2	Unit
R107 009 903	H 3	

For measurement and test purposes. Packaging: Unit

**EXTRACTION TOOL (for lock version only)**



Photo 1

Photo 2

Part number	Photo	Note	To disconnect	Packaging
R282 867 020	1	Axial disconnection	H 2	10 pieces
R282 867 030	2	Lateral disconnection	H 3	

The 2 disconnection tools allows axial and lateral disconnections depending on the occupied space on the PCB.

**INSERTION TOOL (optional)**



Part number
R282 203 020

This optional tool allows you a more precise connection in a limited space.

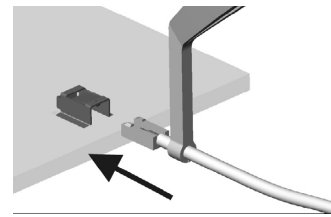

Packaging: Unit

Assembly Instructions

M02

RECEPTACLE SOLDERING PATTERNS FOR COPLANAR LINE

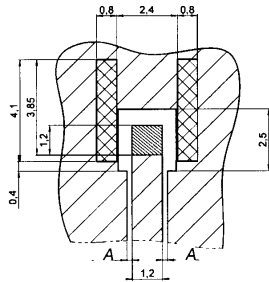

H2 type receptacle

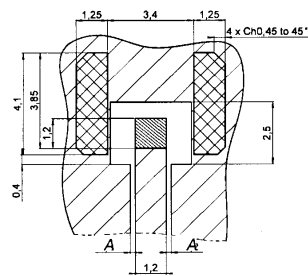

Part number
R107 003 010



H3 type receptacle

Part number
R107 303 040

PCB thickness (mm)	Coplanar ligne A (mm)
0.8	0.183
1.0	0.190
1.2	0.195
1.6	0.20

-  Gold over Nickel preferred for solder paste  
Gold can be replaced by tin lead (see test report SC2000.02.6587)
-  Gold over Nickel contact area free of any surface contaminant
-  Ground + varnish

SMT NOZZLE

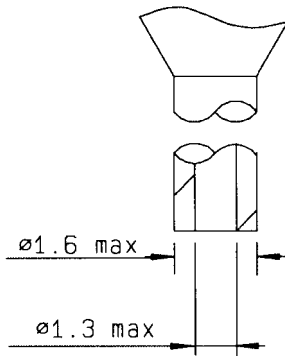

Automated pick and place machines use standard tooling to peel the antistatic film off. Sometimes the "A" dimension of this tool is shorter than the overall "B" width between the two legs of the receptacle. There is therefore a risk for the two legs being deformed while they pass through the tool during the suction operation. The user must then widen the "A" dimension of the peeling tool.

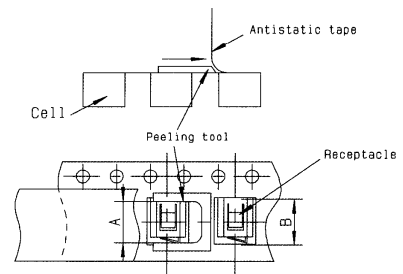

Interface

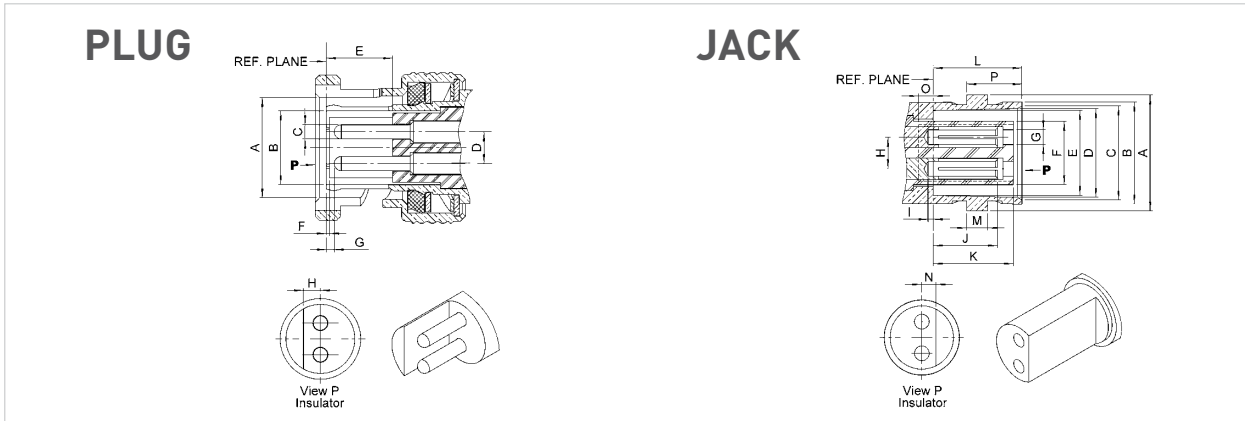

Letter	mm		inch	
	min.	max.	min.	max.
A DIA	9.78	9.91	.385	.390
B DIA	6.70	6.77	.264	.267
C DIA	1.31	1.36	.052	.054
D	2.95	3.05	.116	.120
E	7.6	7.9	.299	.311
F	-0.05	0.15	.002	.006
G	0.85	1.55	.033	.061
H	1.55	1.65	.061	.065

Letter	mm		inch	
	min.	max.	min.	max.
A DIA	10.93	11.09	.430	.437
B DIA	9.60	9.70	.378	.382
C DIA	8.79	9.04	.346	.356
D DIA	8.31	8.46	.327	.333
E DIA	8.09	8.15	.319	.321
F DIA	5.9	6.0	.232	.236
G DIA	1.4	1.45	.055	.057
H	2.95	3.05	.116	.120
I	-0.1	0.8	-.004	.031
J	5.3	5.7	.209	.224
K	7.05	7.35	.278	.289
L	8.36	8.46	.327	.335
M	1.91	2.06	.075	.081
N	1.45	1.55	.057	.061
O	0.35	0.85	.014	.033

Characteristics

Bayonet lock coupling with polarization

ELECTRICAL AND ENVIRONMENTAL CHARACTERISTICS

Dielectric withstanding voltage	Between pins Between pins and body	1.500 volts RMS, 50 Hz
Maximum intensity		3.5 Amp
Insulation resistance	Between pins Between pins and body	> 10 <sup>5</sup> MΩ
Contact resistance		< 1 mΩ at 1 Amp
Capacity at 1 MHz	Between pins Between pins and body	< 1.3 pF < 3.2 pF
Frequency range		DC - 0.5 GHz
Temperature range		-40 +100° C

MATERIALS

All metal parts under stress	Beryllium copper
Other metal parts	Brass
Insulators	Polyamide and diallyphtalate
Gaskets	Neoprene



Plugs and Jacks

**STRAIGHT PLUGS FOR ARMOUR TWINAXIAL CABLE**

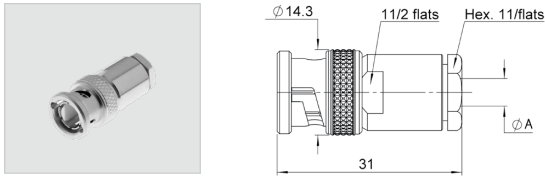

Cable group dia	Part number	Dimensions (mm) A
Twinaxial 4	R605 004 000	4.6
Twinaxial 5	R605 005 000	5.6
Twinaxial 6	R605 006 000	6.6

**RIGHT ANGLE PLUG**

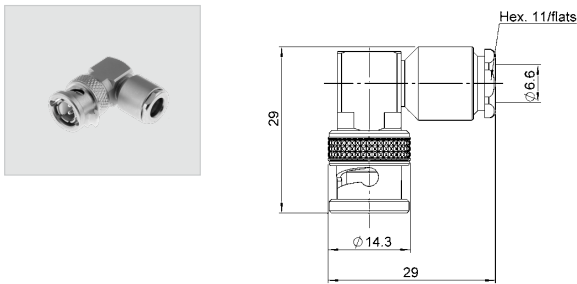

Cable group dia	Part number
Twinaxial 6	R605 156 000

**STRAIGHT JACKS**

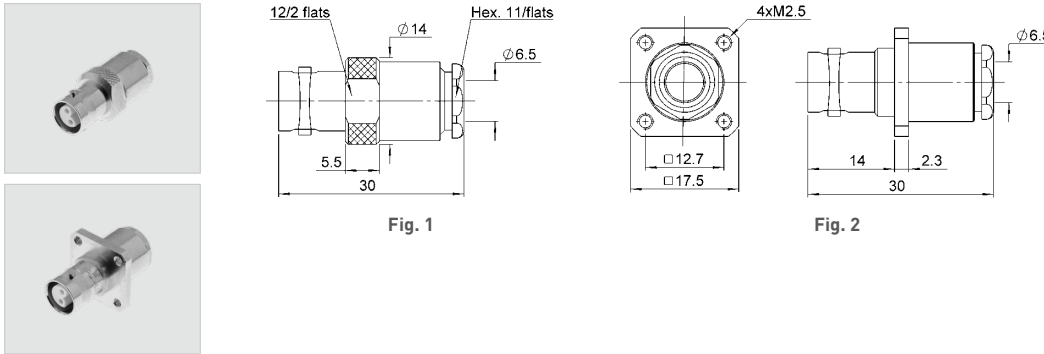

Cable group dia	Part number	Fig.	Panel drilling	Note
Twinaxial 6	R605 206 000	1	P01	-
	R605 256 000	2		Square flange

Receptacles and Caps

RECEPTACLES

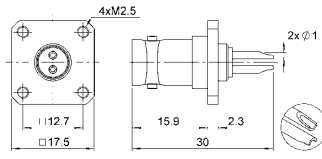

Fig. 1

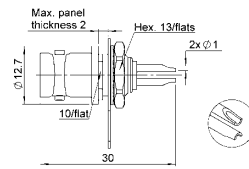

Fig. 2

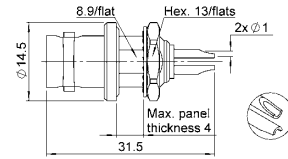
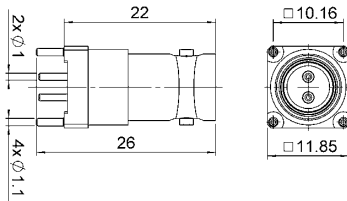

Fig. 3



Part number	Fig.	Panel drilling	Note
R605 400 000	1	P02	Square flange
R605 550 000	2	P04	Rear fixing
R605 550 020			Front mounting
R605 600 000	3	P05	Waterproof

PCB RECEPTACLES



Part number	Panel drilling
R605 440 000	P03

CAPS

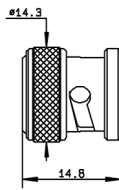

Fig. 1

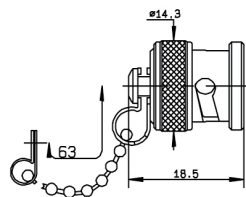

Fig. 2

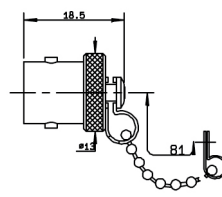

Fig. 3



Part number	Fig.	Note
R141 802 000	1	Male
R141 812 000	2	Male with chain
R141 842 000	3	Female with chain

Gasket

**GASKET**

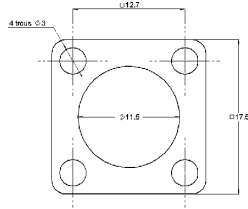

Part number
R280 503 000

Panel Drilling

**PO1**

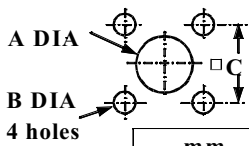

	mm	
	Maxi	mini
A (R. Mount)	11.3	11.2
A (F. Mount)	13	12.9
B	2.7	2.6
C	12.75	12.65

**PO2**

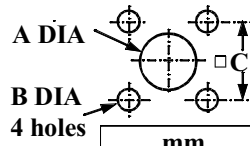

	mm	
	Maxi	mini
A	11.3	11.2
B	2.7	2.6
C	12.75	12.65

**PO3**

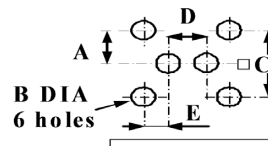

	mm	
	Maxi	mini
A	5.18	4.98
B	1.3	1.2
C	10.26	10.06
D	3.1	2.9
E	3.68	3.48

**PO4**

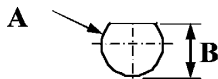

	mm	
	Maxi	mini
A	10.2	10.1
B	11.1	11

**PO5**

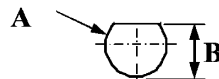

	mm	
	Maxi	mini
A	9.6	9.5
B	9.1	9

Interface

UHF

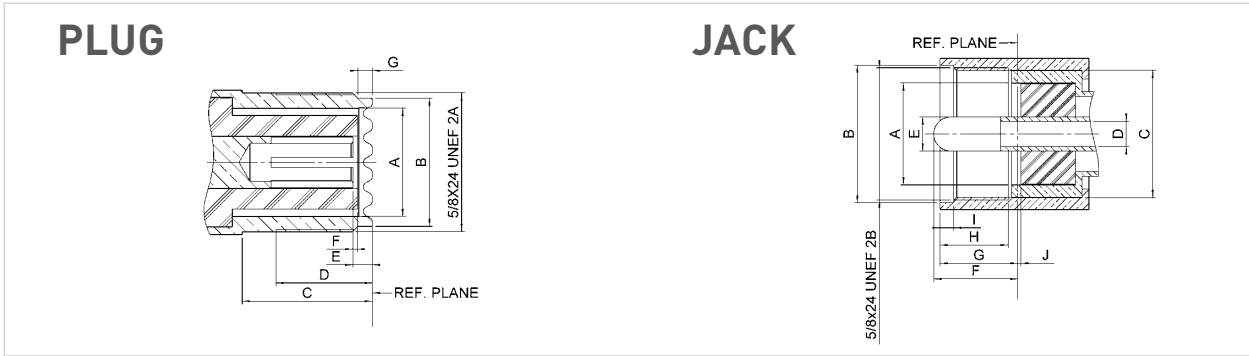

Letter	mm		inch	
	min.	max.	min.	max.
A DIA	11.56	12.22	.455	.481
B DIA	16.00	---	.630	---
C DIA	13.92	---	.548	---
D DIA	---	3.35	---	.132
E DIA	3.912	4.013	.154	.158
F	---	11.10	---	.437
G	---	9.91	---	.390
H	8.76	---	.335	---
I	1.19	4.27	.047	.168
J	0.00	---	.000	---

Letter	mm		inch	
	min.	max.	min.	max.
A DIA	11.56	12.22	.455	.481
B DIA	14.00	14.25	.551	.561
C	11.10	---	.437	---
D	7.87	---	.310	---
E	1.02	---	.040	---
F	0.03	---	.001	---
G	1.19	1.96	.047	.077

Characteristics

Test / Characteristics	Values / Remarks
------------------------	------------------

**ELECTRICAL CHARACTERISTICS**

Impedance	50Ω
Maximum frequency range	500 MHz
Test voltage (At sea level)	2000 V rms - 50 Hz
Working voltage (At sea level)	750 V
Insulation resistance (Under 500 V)	≤ 5 GΩ
Contact resistance • Centre contact • Outer contact	5 mΩ max 5 mΩ max

**MECHANICAL CHARACTERISTICS**

Mating cycles	500
---------------	-----

**ENVIRONMENTAL CHARACTERISTICS**

Temperature range • PTFE • Bakelite • Styramic	-55°C to + 155°C -40°C to + 165°C -40°C to + 70°C
Salt spray	48 Hrs

**MATERIALS**

Contacts and interfaces	Heat treated beryllium copper
Other parts	Brass
Insulator	PTFE (T) - bakelite (B) or styramic (St.)
Gaskets	Neoprene or silicone rubber

All dimensions are given in mm.

Plugs, Receptacles and Adapter

UHF

STRAIGHT PLUGS

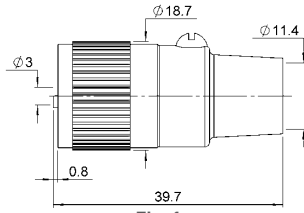

Fig. 1

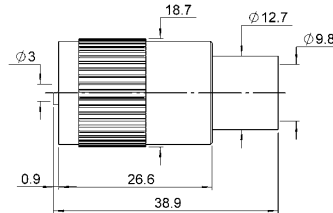

Fig. 2



Cable group	Cable group dia.	Part number	Fig.	Note
RG213 / RG393 / RG11 / RG12 / RG144	10/50+75Ω	R155 003 000	1	Insulator: PTFE
		R155 005 000	2	

RECEPTACLES

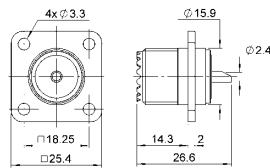

Fig. 1

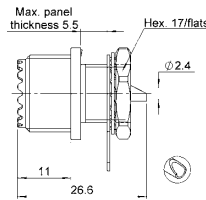
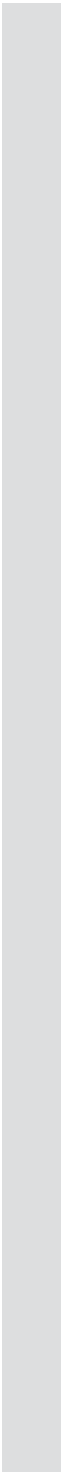

Fig. 2

Part number	Fig.	Panel drilling	Note
R155 405 000	1	P01	Square flange - Solder pot - Insulator: PTFE
R155 560 000	2	P02	Bulkhead - Solder pot - Insulator: PTFE

NOTE



SIMPLIFICATION IS OUR INNOVATION

# NOTE

