



4.1-9.5/4.3-10/QLI/7-16

R170/R183/R184/R185

Contents

7/16

Introduction..... 13-4 to 13-5
 Interface 13-6
 Characteristics 13-7 to 13-8
 Plugs 13-9
 Jacks 13-10 to 13-11
 Receptacles..... 13-11
 Adapters 13-12
 Caps..... 13-12

COMPOSITE 7/16

Introduction..... 13-4 to 13-5
 Interface 13-6
 Characteristics 13-8
 Jacks 13-13
 Receptacles..... 13-13
 Panel drilling 13-14

QLI

Introduction..... 13-15
 Characteristics 13-16
 Plugs 13-17
 Jacks 13-17 to 13-18
 Protective Cap 13-18

4.3-10

Introduction..... 13-19
 Characteristics 13-20
 Plugs 13-21 to 13-22
 Jacks 13-22
 Panel drilling 13-22

4.1-9.5

Introduction..... 13-23
 Characteristics 13-24
 Plugs 13-25
 Jacks 13-25

Introduction

50Ω

DC - 7.5 GHz

GENERAL

- Standard coaxial connectors
- Screw-on coupling
- High power rating
- Excellent RF performance

APPLICABLE STANDARDS

- IEC 169-4
- DIN 47223
- CECC 22 190

APPLICATIONS

- Mobile communication infrastructure networks: combiner, diplexer, filter...
- Jumper and feeder cables assemblies
- Radio links
- Indoor and outdoor applications

Radiall's 7/16 series has been developed using the latest technology advances in connector design. These connectors are easy to use, highly reliable, innovative and are designed to meet the needs of the telecommunications market. The complete connector series feature the following characteristics:

- An extensive range, with optimized component part design
- An upgraded cross-knurled coupling nut allowing better manual tightening

Composite 7/16

Radiall expanded its line of innovative 7/16 composite connectors with jacks and receptacles as a lightweight, low cost alternative to brass connectors. Manufactured with corrosion-proof, composite materials these new single-piece connectors are UV resistant, meeting IEC 68-2-5 and IEC-68-2-9 to withstand all environments, including harsh outdoor installations. Radiall now offers over 20 different variations. The selection of the composite materials is a result of an in-depth competitive analysis of creeping speeds of zinc and aluminum alloys. Not only do the composite materials offer considerable performance advantages guaranteeing up to 500 matings; but with more than a 50% reduction in weight, this receptacle reduces the overall weight of the final module as well as transportation costs.

Introduction

High performance range

- Frequency range: DC - 7.5 GHz
- 2 types of coupling nut:
 - Cross-knurled and 6 flats 27 mm wide coupling nut (3 000 N.cm)
 - 6 flats coupling nut (32 mm wide), allowing high coupling torque (3 500 N.cm) when used with a torque wrench
- Intermodulation performance: 2 levels
 - 125 dBm cable assemblies
 - 110 dBm connectors and cable assemblies

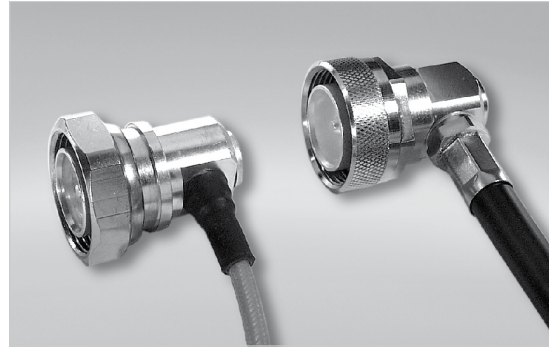

2 types of coupling nut

Radiall has developed its intermodulation measurement equipment following the IEC 46 D/292/NP standard proposal. It is aimed at third-order IMP measurements through the reflection method. The range of this test set-up is -132 dBm (-175 dBc) under 2 x 20 W.

- High performance non-magnetic material (brass) and plating (silver) with anti-tarnishing finish (strike of BBR)
- Non-slotted outer contact on standard products
- The 7/16 connector series benefits from a complete easy-to-use range of tooling



Custom models

To fulfill customer requirements, Radiall offers complete design of custom connectors according to the 7/16 series standard.

What is Intermodulation?

Intermodulation (IM) is an undesired modulation that leads to a distortion of the output high-frequency carrier. It is defined as the ratio of the 3rd order intermodulation products and the incident signal power because the most troublesome IM products are those of 3rd order.

For more detailed information, including our intermodulation measurement system and our product range, please visit www.radiall.com

Interface

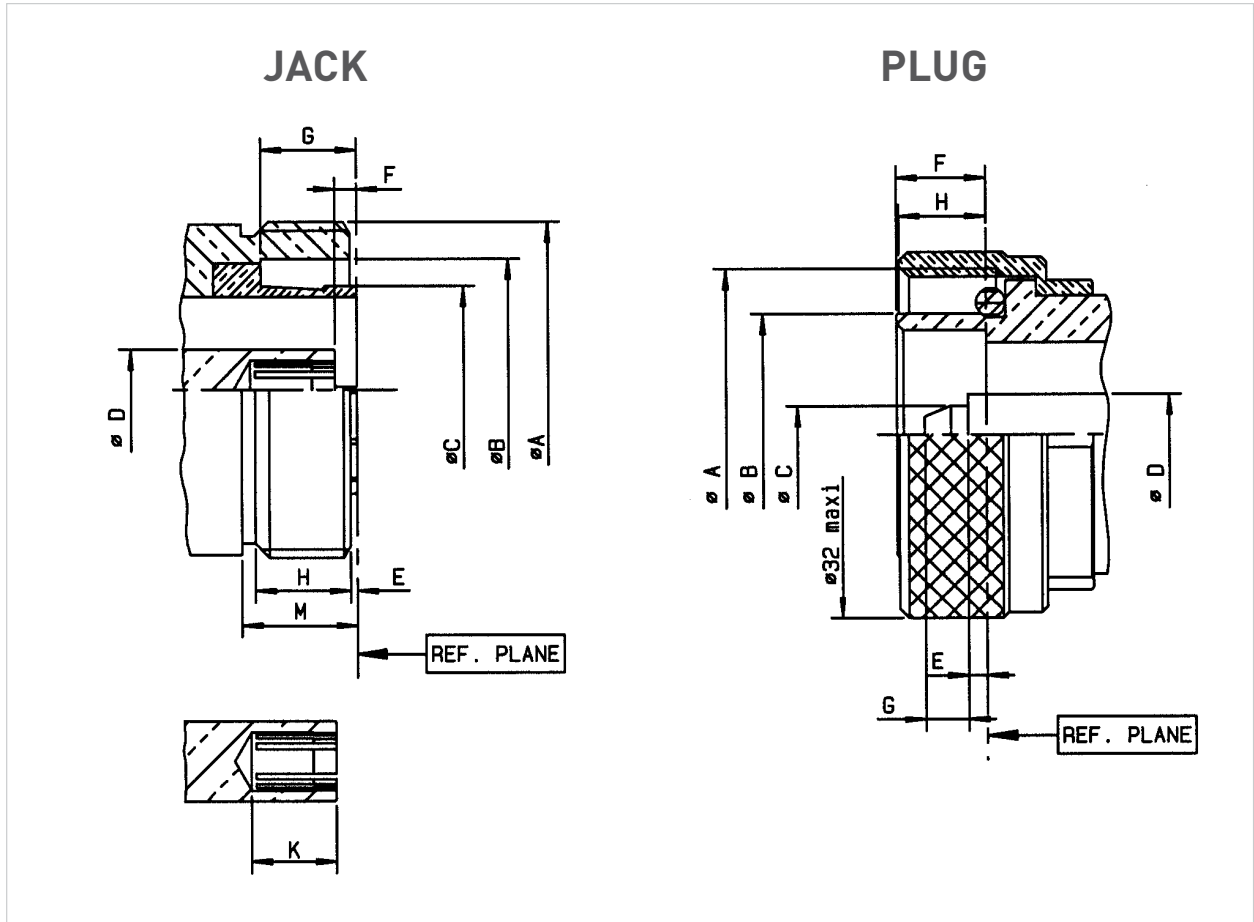

Letter	mm		inch	
	min.	max.	min.	max.
A DIA	M29 X 1.5		M29 X 1.5	
B DIA	22.5	22.7	.885	.893
C DIA	17.9	17.96	.704	.707
D DIA	6.95	7.00	.273	.275
E	0.50	0.70	.019	.027
F	1.77	2.07	.069	.081
G	8.20	8.40	.322	.330
H	8.25	8.75	.324	.344
K	7.25	7.55	.285	.297

Letter	mm		inch	
	min.	max.	min.	max.
A DIA	M29 X 1.5		M29 X 1.5	
B DIA	20.8	21.0	.818	.826
C DIA	4.97	5.03	.195	.198
D DIA	6.95	7.00	.273	.275
E	1.47	1.77	.057	.069
F	7.40	7.80	.291	.307
G	3.60	4.00	.141	.157
H	7.30	7.80	.287	.307

Characteristics

Test / Characteristics	Standard reference	Values / Remarks			
ELECTRICAL CHARACTERISTICS					
Impedance	-	50Ω			
Frequency range	-	DC - 7.5 GHz			
Typical V.S.W.R.	-	1 GHz	2.5 GHz	5 GHz	7.5 GHz
• Straight models	-	1.10 max from DC to 3 GHz - 1.20 max from 3 to 7.5 GHz			
RG213-RG214-RG393	-	1.04	1.06	1.08	1.10
.141"	-	1.04	1.07	1.08	1.20
.250"	-	1.03	1.05	1.11	1.13
1/2" superflexible corrugated	-	1.02	1.04	1.05	1.05
3/8" superflexible corrugated	-	1.03	1.03	1.12	1.20
1/4" superflexible corrugated	-	1.01	1.02	1.09	1.17
• Right angle models	-	1.15 max from DC to 3 GHz			
RG213-RG214-RG393	-	1.02	1.04	1.12	1.50
1/2" superflexible corrugated	-	1.04	1.04	1.14	1.60
3/8" superflexible corrugated	-	1.05	1.08	1.12	1.80
1/4" superflexible corrugated	-	1.02	1.06	1.13	1.60
Intermodulation product (IMP ₃)	-	-110 dBm typ. [- 153 dBc typ / 20 W] -125 dBm typ. [- 168 dBc typ. / 20 W]			
• Connectors	-				
• Home made cable assemblies	-				
Insertion loss (dB)					
Straight connectors and right-angle connectors	MIL	0.05 vF (GHz)			
RF Leakage	CECC	130 dB at 1 GHz			
Insulation resistance	CECC	10 000 MΩ min			
Contact resistance					
• Center contact	CECC	< 0.4 mΩ			
• Outer contact		≤ 1.5 mΩ			
Working voltage in VRMS at sea level	CECC	2 700			
Dielectric withstanding voltage in VRMS					
• At sea level	CECC	4 000			
(at 70, 000 feet)		350			

MECHANICAL CHARACTERISTICS

Durability	CECC	500 matings
Force to engage and disengage	CECC	15 N
Recommended coupling nut torque		
• Hex. coupling nut	-	3 500 Ncm (with torque wrench R 282 303 500)
• Hex. + cross knurl coupling nut	-	3 000 Ncm (with torque wrench R 282 303 520)
Proof torque	CECC	3 500 Ncm
Coupling nut retention force	CECC	1 000 N
Cable retention force		
Cable 5/50 & 10/50		250 N
Cable 1/4"	CECC	200 N
Cable 3/8"		250 N
Cable 1/2"		350 N
Cable 7/8"		500 N
Center contact retention force	CECC	200 N

ENVIRONMENTAL CHARACTERISTICS

Temperature range		
• Flexible cables and corrugated cables	CECC	- 55 °C + 155 °C
• Semi-rigid cables		- 55 °C + 105 °C
Thermo cycling test	CECC	- 55 °C / + 155 °C / 56 days
Rapid change of temperature	IEC	- 55 °C / + 155 °C / 5 cycles
High temperature test	CECC	1000 hours / 155 °C
Corrosion salt spray	IEC	48 hours / Na Cl 5% / 35 °C
Vibration	CECC	98 m/s ² - 10 Hz at 500 Hz
Moisture resistance		
• Clamp type	IEC 529	IP67
• Crimp type		IP65 (with heatshrink sleeve)
• Home made cable assemblies		IP68 (overmolding)
Hermetic test	IEC	5 Pa. cm ³ /s
Leakage	CECC	1 cm ³ /h max

Characteristics

MATERIALS AND PLATINGS

	Material	Plating
Bodies	Brass	Silver + BBR
Nut	Brass	BBR
Center contact • Male • Female	Brass Beryllium copper	Silver
Insulator	PTFE	-
Gasket	Silicon rubber	-

POWER RANGE

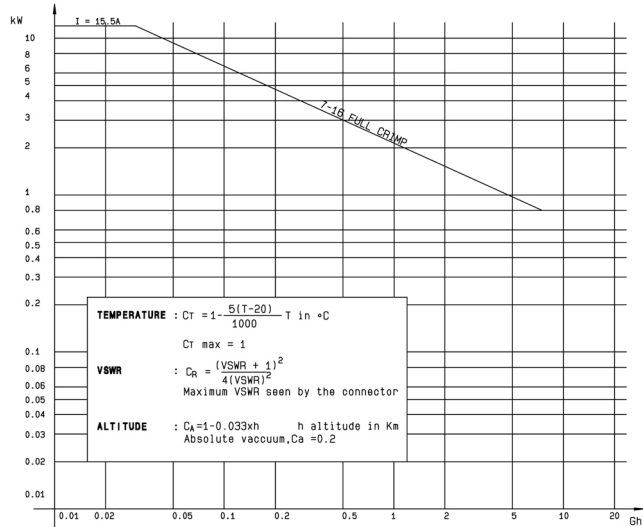

Composite 7/16 Characteristics

ELECTRICAL CHARACTERISTICS

Frequency range	DC - 7.5 GHz
VSWR	1.06@DC-3 GHz - 1.10@DC - 3-7.5 GHz
High working voltage	> 2700 V
Very low intermodulation	IMP3 < -125 dBm under 2 carriers of +43dBm And typically < -130 dBm
Power handling	> 800 W@ 935 MHz

MECHANICAL CHARACTERISTICS

Longlife duration	up to 500 mating cycles
Coupling torque	35 Nm or less
Coupling strength	1000 N
Center contact retention / axial force	> 200 N
Center contact retention / torque	> 80 Ncm

ENVIRONMENTAL CHARACTERISTICS

Temperature range	-40°C / +85°C
Humidity	Up to 100% @ 20°C
Flammability rating	UL94-V0
UV resistance	IEC 68-2-5 / IEC 68-2-9
Waterproof	IP67

Straight Plugs and Right Angle Plugs

STRAIGHT PLUGS, FOR FLEXIBLE AND SEMI-RIGID CABLE

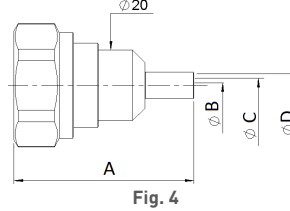
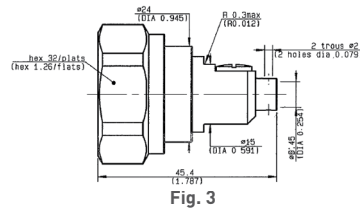
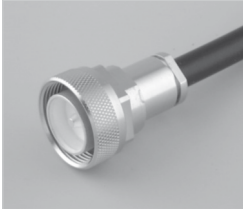
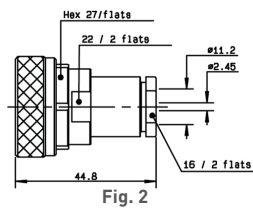
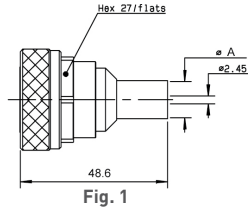
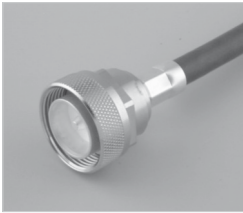

Cable group	Cable group dia.	Part number	Fig.	Dimensions (mm)				Captive center contact	Finish	Note
				A	B	C	D			
RG213 / RG393	10/50/S + D	R185 074 000	1	11.05	-	-	-	Yes	Silver + BBR	Crimp type
RG214	11/50/D	R185 077 000		11.4	-	-	-			Clamp type
RG213 / RG393 / RG214	10 + 11/50/S + D	R185 010 000	2	-	-	-	-	-	Silver + BBR	Solder type
RG401	.250"	R185 054 020	3	-	-	-	-	-	Silver + BBR	Solder type
AEP-240FR	LMR® 240	R185 083 310	4	51.15	1.5	4.05	6.6	Yes	BBR	Clamp type
AEP-400FR	LMR® 400	R185 085 007		49.55	2.82	7.46	11.05			
AEP-600FR	LMR® 600	R185 077 010		58.05	4.7	11.96	15.88			

RIGHT ANGLE PLUGS CRIMP AND CLAMP TYPE FOR FLEXIBLE CABLES

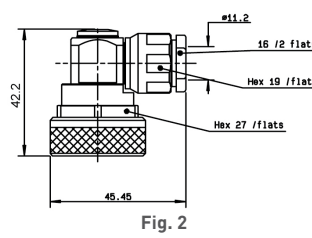
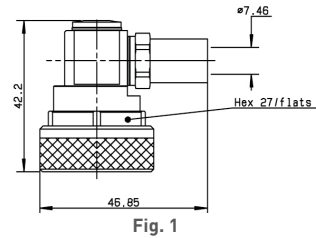
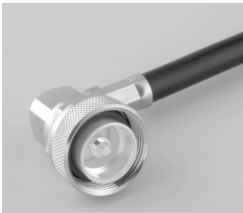

Cable group	Cable group dia.	Part number	Fig.	Captive center contact	Finish	Note
RG213	10/50/S	R185 174 000	1	Yes	Silver + BBR	Crimp type
RG214	11/50/D	R185 177 000				Clamp type
RG393 / RG214	10+11/50/D	R185 160 000	2	-	-	Clamp type

Straight Jacks and Square Flange Jacks

STRAIGHT JACKS

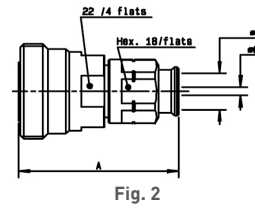
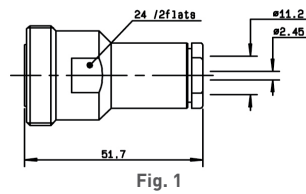

Cable group	Cable group dia.	Part number	Fig.	Dimensions (mm)			Captive center contact	Finish	Note
				A	B	C			
RG393 / RG214	10 + 11/50 D	R185 210 000	1	-	-	-	Yes	Silver + BBR	Clamp type
-	1/4" superflexible corrugated	R185 215 200	2	49.45	7.95	4.7			
-	1/2" superflexible corrugated	R185 216 200		50	14	8.8			
-	3/8" superflexible corrugated	R185 217 200		50	11	7.1			

STRAIGHT SQUARE FLANGE JACKS

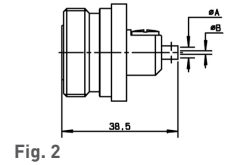
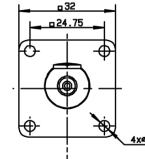
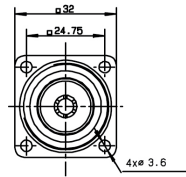
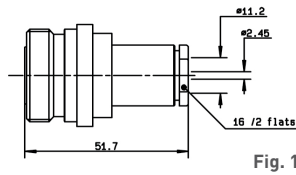
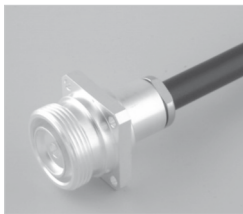

Cable group	Cable group dia.	Part number	Fig.	Captive center contact	Dimensions (mm)			Panel drilling	Finish	Note
					A	B	C			
RG393 / RG214	10 + 11/50 D	R185 260 000	1	Yes	-	-	-	P01	Silver + BBR	Clamp type for flexible cables
RG402	.141"	R185 252 000	2		3.65	0.996	3.6	P01		Solder type for semi-rigid cables

Bulkhead Jacks and Receptacles

STRAIGHT BULKHEAD JACKS FOR FLEXIBLE CABLES AND CORRUGATED CABLES

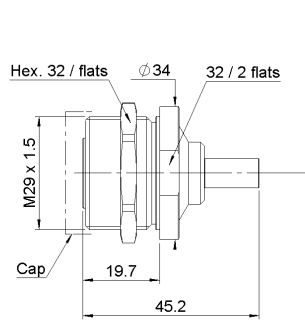

Fig. 1

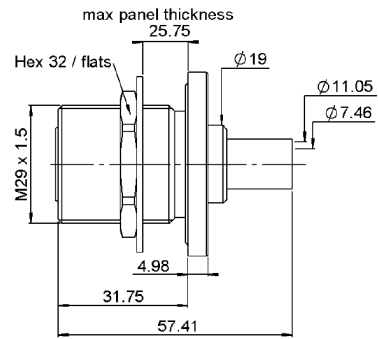

Fig. 2

Cable group	Cable group dia.	Part number	Fig.	Dimensions (mm)					Captive center contact	Panel drilling	Finish	Note
				A	B	C	D	E				
AEP-240FR	LMR® 240	R185 314 100	1	19.7	45.2	1.5	4.05	6.6				
AEP-400FR	LMR® 400	R185 320 020	2	31.75	57.41	7.46	11.05	25.75	Yes	P02	BBR	Clamp type

STRAIGHT FLANGE FEMALE RECEPTACLES

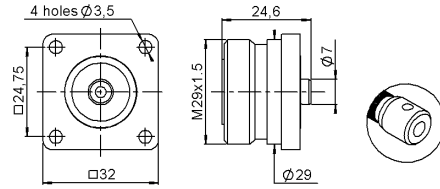
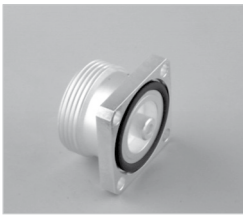

Fig. 1

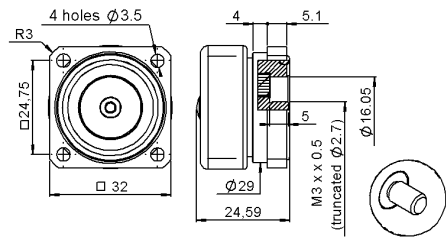

Fig. 2

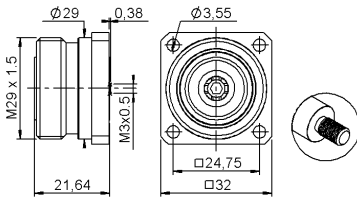

Fig. 3

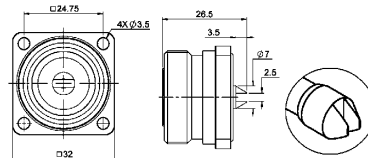

Fig. 4

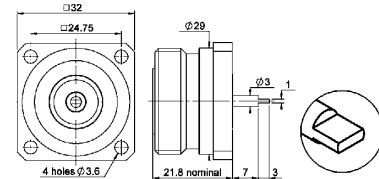
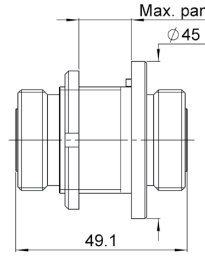
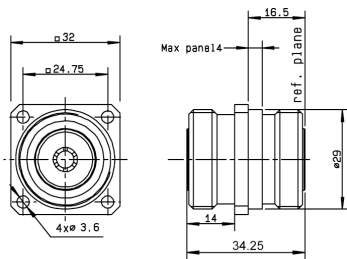
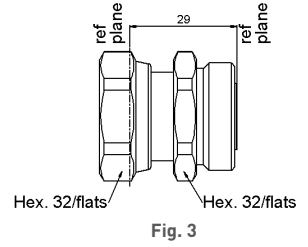
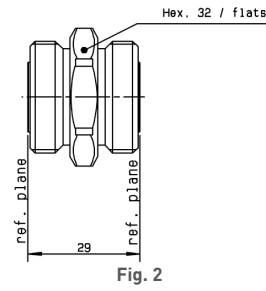
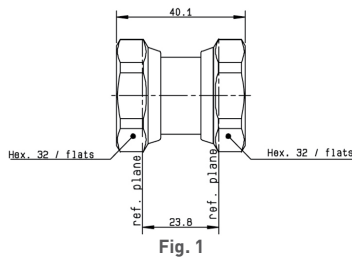

Fig. 5

Part number	Fig.	Captive center contact	Panel drilling	Finish	Slotted outer contact	Packaging	Note
R185 403 547	1	Yes	P03	BBR	No	20	With solder pot contact
R185 405 200	2		P05	Silver + Copper	Yes	-	Panel seal flange mount
R185 406 090	3		P05	BBR	No	50	M3
R185 404 200	4		P05	Silver + Copper		20	With slotted contact
R185 403 490	5		P04			20	With tab contact

In Series Adapters and Caps

IN SERIES ADAPTERS



Part number	Fig.	Captive center contact	Panel drilling	Finish	Note
R185 703 000	1	Yes	-	Silver + Copper	Male - Male
R185 705 000	2		-		Female - Female
R185 707 000	3		-		Male - Female
R185 710 000	4		P01	Female - Female flange mount	
R185 730 020	5		P06	Silver + BBR	Female - Female

PROTECTIVE CAPS

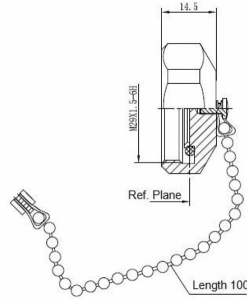

Part Number	Note
R185 812 007	Male with chain

Square Flange Jacks

SQUARE FLANGE JACK RECEPTACLE SOLDER TYPE, PANEL SEAL

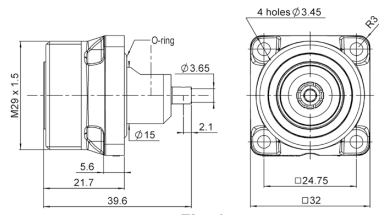

Fig. 1

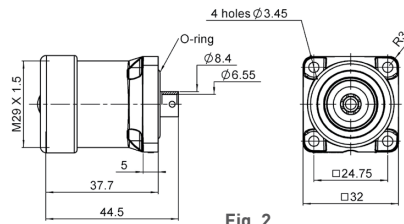

Fig. 2

Cable group	Cable group dia.	Part number	Fig.	Panel drilling
RG402	.141"	R187 403 010	1	P07
RG401	.250"	R187 130 000	2	

SQUARE FLANGE JACK RECEPTACLE PANEL SEAL

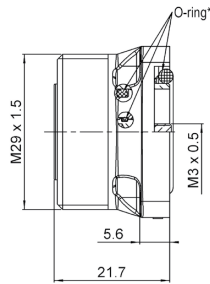
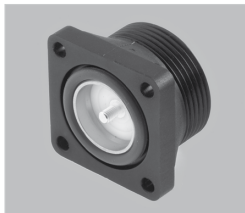

Fig. 1

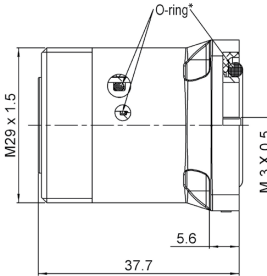

Fig. 2

Part number	Fig.	Captive center contact	Waterproof interface	Color	Panel drilling
R187 403 000	1	No	No	Black	P07
R187 403 100			Yes		
R187 406 000		Yes	No		
R187 406 100	2		Yes		
R187 413 000		No	No		
R187 413 100			Yes		
R187 416 000		Yes	No		
R187 416 100			Yes		

Available packaged in increments of 20 units
 Processed according to customer needs
 * O-ring inside, only on the waterproof models

Panel Drilling

P01

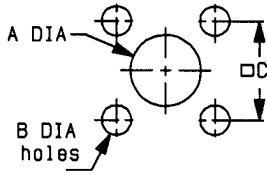

	MM		INCH	
	maxi	mini	maxi	mini
A	29.2	29.1	1.15	1.146
B	3.7	3.6	0.146	0.142
C	24.8	24.7	0.976	0.972

P02

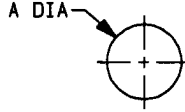

A	MM		INCH	
	maxi	mini	maxi	mini
	29.2	29.1	1.15	1.146

P03

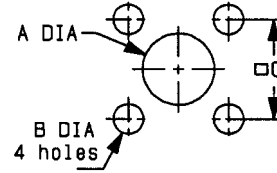

	MM		INCH	
	maxi	mini	maxi	mini
A (R. Mount)	16.2	16	0.638	0.63
A (F. Mount)	29.3	29.1	1.154	1.146
B	3.7	3.6	0.146	0.142
C	24.8	24.7	0.976	0.972

P04

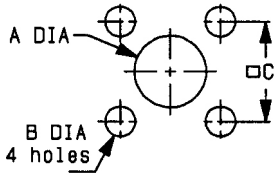

	MM		INCH	
	maxi	mini	maxi	mini
A	12.3	12.1	0.484	0.476
B	3.8	3.7	0.15	0.146
C	24.8	24.7	0.976	0.972

P05

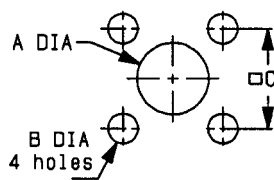

A	MM		INCH	
	maxi	mini	maxi	mini
	16.2	16	0.638	0.63
B	3.7	3.6	0.146	0.142
C	24.8	24.7	0.976	0.972

P06

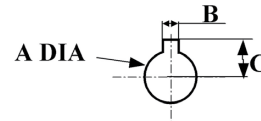

	mm	
	Maxi	mini
A	30.55	30.45
B	3.3	3.2
C	17.6	17.5

P07

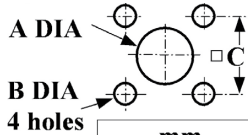

	mm	
	Maxi	mini
A	16.2	16
B	3.7	3.6
C	24.8	24.7

Introduction



Overview

Radiall has expanded its broad range of Quick Lock products with QLI (Quick Lock Low Intermodulation). With the QLI, Radiall introduces a new solution for harsh environments, where performance and safety are critical. QLI connectors are designed to provide performance similar to DIN 7/16 with a very low intermodulation level, and a quick and safe connection, without any tools. Compared to 7/16, QLI is cheaper but also smaller (-31%) and lighter (-62%) offering an easy to use concept with its bayonet coupling system.

QLI is double sealing and offers special anti-corrosion & watertight plating, which makes it the best choice for outdoor installations and also indoor applications where the high performance is required. QLI connectors are available in plugs, jacks, straight or right angle, square sockets & bulkhead models with a compact design allowing high density integration (saving time on field installation).

Its simple jack design makes QLI robust and easy to clean when equipment is subjected to severe conditions in the field.

HIGH PERFORMANCE

- Impedance 50Ω
- Frequency range DC - 6 GHz
- Very low intermodulation level $\leq -163\text{dBc}$
- Bayonet locking concept provides coupling retention force 450 N
- VSWR $1.04 + 0.02 \sqrt{f}$
- Meets all requirements for IP67

50Ω

DC - 6 GHz

GENERAL

- Quick Lock Low Intermodulation connector
- Bayonet coupling mechanism
- High power rating
- 31% smaller & 60% lighter than 7/16

APPLICABLE STANDARDS

- IEC 61169
- MIL PRF 39012

APPLICATIONS

- Telecom
- Medical
- Industrial
- Indoor and outdoor use

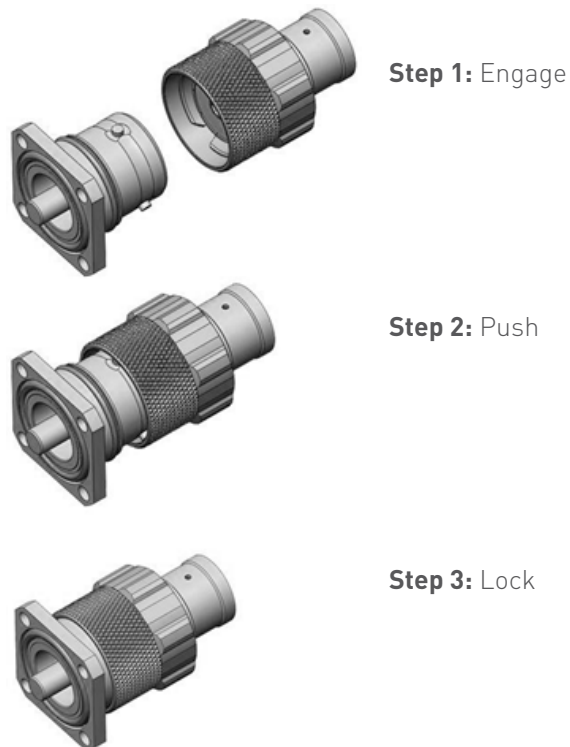

Step 1: Engage

Step 2: Push

Step 3: Lock

- High mating life
- 3 step connection: Engage, Push & Lock
- Intuitive design concept
- Light weight
- Reduced size allows more space for other components
- RF Power: Up to 1000 W @ 2 GHz

Characteristics

Test / Characteristics	Values / Remarks
------------------------	------------------

ELECTRICAL CHARACTERISTICS

Impedance	50Ω
Frequency range	DC - 6 GHz
Typical VSWR	1.04 + 0.02 f (GHz)
Maximum insertion loss	0.05 √F (GHz) dB
Insulation resistance	5000 MΩ min
Voltage rating	<=1400 Veff
Dielectric withstanding voltage	>2500 Veff
Contact resistance	≤ 1 mΩ ≤ 1.5 mΩ
• Center contact	
• Outer contact	
Power	1000W @ 2 GHz
Intermodulation	≥163dBc (≥120 dBm) 2x20W
Typical RF Leakage	-100dB@1 GHz; -90dB@3 GHz; -80dB@5 GHz

MECHANICAL CHARACTERISTICS

Mechanical endurance	100 cycles
Engagement & disengagement force	<= 60N <= 50 N
• Engagement	
• Disengagement	
Mating mechanical retention force	450 N min.
Cable retention force	350 N mini with 1/2" S cable
Vibration	IEC 611169-1 10g / 10-500 Hz

ENVIRONMENTAL CHARACTERISTICS

Temperature range	- 55 °C ~ + 120 °C
Moisture resistance	IP67

MATERIALS

Connector bodies	Brass
Male center contact	Bronze / Brass
Female center contact	Bronze
Outer contact	Brass
Other metallic parts	Brass
Insulators	PTFE

PLATING

Bodies	BBR
Outer contact	BBR
Center contact	Silver

Plugs and Jacks

STRAIGHT PLUGS

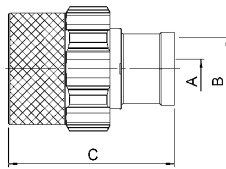
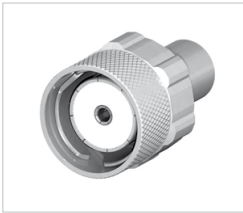

Fig. 1

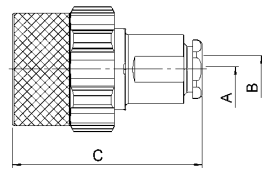
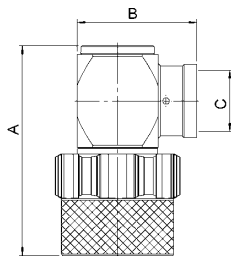

Fig. 2

Cable group	Cable group dia.	Part number	Fig.	Dimensions			Captive center contact	Finish	Packaging	Note
				A	B	C				
-	1/2" Superflexible corrugated	R184 061 007	1	3.8	12.55	29	Yes	Silver + BBR	50	Solder
-	1/4" Superflexible corrugated	R184 062 007		2	6.8	28.5				
RG58 / RG141 / KX15	5/50S	R184 082 007		1.05	5.41	40.15				
LMR®400 / LMR400® FR / AEP-400FR	10.3/50S	R184 086 007		2.82	11.05	39				
AEP-600F / LMR®600	15/50S	R184 087 007		4.7	15.88	42				
RG58 / RG141 / RG223 / RG400	5/50S+D	R184 006 007	2	1.05	5.6	38.5	Yes	Silver + BBR	50	Clamp
RG213 / RG214 / RG393	10+11/50S+D	R184 018 007		2.45	11.2	46.5				
-	1/2" Superflexible corrugated	R184 037 007		N/A	14	49.7				

RIGHT ANGLE PLUGS



Cable group dia.	Part number	Dimensions			Captive center contact	Finish	Packaging	Note
		A	B	C				
1/2" Superflexible corrugated	R184 191 007	42.7	24.40	12.55	Yes	Silver + BBR	50	Solder

STRAIGHT JACK

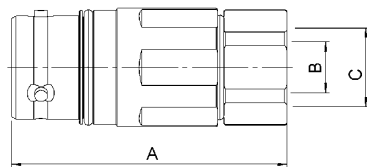

Cable group dia.	Part number	Dimensions			Captive center contact	Finish	Packaging	Note
		A	B	C				
1/2" Superflexible corrugated	R184 216 007	49.1	9.00	14.00	Yes	Silver + BBR	50	Clamp

Jacks and Cap

BULKHEAD STRAIGHT JACK

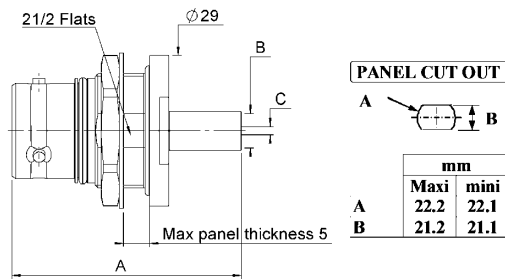

Cable group	Cable group dia.	Part number	Dimensions			Captive center contact	Finish	Packaging	Note
			A	B	C				
LMR®240 / AEP-240FR	6.1/50S	R184 335 007	44.2	6.60	1.50	Yes	Silver + BBR	50	Crimp
RG213 / RG214 / RG393	10+11/50S+D	R184 339 007	43.6	11.20	2.45				Clamp

SQUARE FLANGE STRAIGHT JACK

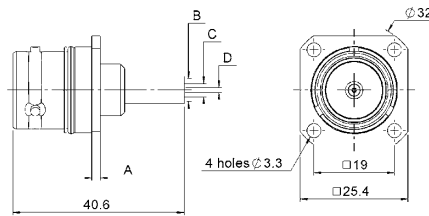

Fig. 1

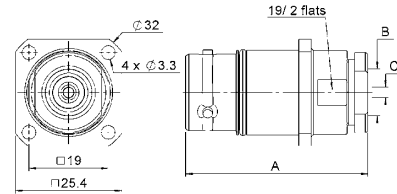

Fig. 2

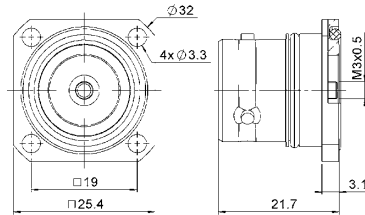
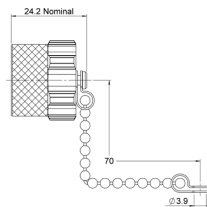

Fig. 3

Cable group	Cable group dia.	Part number	Fig	Dimensions				Captive center contact	Finish	Packaging	Note
				A	B	C	D				
RG58 / KX15 / RG141	5/50S	R184 282 007	1	41	5.41	3.11	1.05	Yes	Silver + BBR	50	Crimp
RG393 / RG214 / RG213	10+11/50S+D	R184 339 007	2	43.6	11.20	2.45	Clamp				
-	M3	R184 405 007	3	-	-	-	-				

PROTECTIVE CAP



Part number	Note
R184 960 007	Metallic male with chain - IP67

Introduction



50Ω

DC - 6 GHz

GENERAL

- Low Intermodulation connector
- Screw-on & Push-pull coupling mechanism
- High power rating
- 30% smaller & 60% lighter than 7/16

APPLICABLE STANDARDS

- IEC 61169
- MIL PRF 39012

APPLICATIONS

- Telecom
- Medical
- Industrial
- Indoor and outdoor use

Overview

Designed for major telecom equipment manufacturers, the 4.3-10 series offers a small, lightweight solution for outdoor telecom applications where high performance is essential and low intermodulation is required.

Radiall's broad product portfolio includes the 4.3-10, 4.1-9.5, 7/16 and the innovative QLI (Quick Lock Low Intermodulation) connector. These solutions are suitable for harsh environments where reliability is required.

Available in a variety of configurations including:

- Jack/Bulkhead
- Square flange receptacles and plugs
- Right angle models
- Solder, crimp and clamp models
- Screw-on and push-pull coupling mechanism

4.3-10 connectors are 30% smaller and 60% lighter than comparable 7/16 square flange jack receptacles. The new interface features a high intermodulation level ranging from 0-6 GHz and provides a low intermodulation level at $<-166\text{dBc}$.

Radiall's 4.3-10 connector solution is designed in accordance with international standards and manufactured to meet environmental safety requirements.

HIGH PERFORMANCE

- Impedance 50Ω
- Frequency range DC ~ 6 GHz
- Very low intermodulation level $\leq -166\text{dBc}$
- Screw-on and Push-pull coupling mechanism for safety and easy to use
- VSWR 1.04 + 0.01 vf
- Meets all requirements for IP67
- High mating life
- 3 step connection: Engage, Push & Lock
- Intuitive design concept
- Light weight
- Reduced size allows more space for other components
- RF Power: Up to 500 W @ 2 GHz

Characteristics

Test / Characteristics	Values / Remarks
ELECTRICAL CHARACTERISTICS	
Impedance	50 Ω
Frequency range	DC - 6 GHz
Typical VSWR	1.04 + 0.01 f [GHz]
Maximum insertion loss	0.05 \sqrt{f} [GHz] dB
Insulation resistance	5000 M Ω min
Voltage rating	\leq 1000 Veff
Dielectric withstanding voltage	\geq 2500 Veff
Contact resistance	\leq 1 m Ω \leq 1.5 m Ω
• Center contact • Outer contact	
Power	500W @ 2 GHz
Intermodulation	\leq 165dBc (\geq 120 dBm) 2x20W
Typical RF Leakage	-110dB@3 GHz; -100dB@3-6 GHz

MECHANICAL CHARACTERISTICS

Mechanical endurance	100 cycles	
Mating force (push-pull version)	\leq 100 N \leq 80 N	IEC 61169-1 §9.3.6
• Engagement force for mating • Separation force for mating		
Mating torque (tool screw type)	5 N. m	IEC 61169-1 §9.3.6
• Torque		
Mating mechanical retention force	450 N min.	
Cable retention force	350 N mini with 1/2" S cable	
Vibration	10g 2 Hz to 200 Hz	IEC 61169-1 § 9.3.3

ENVIRONMENTAL CHARACTERISTICS

Temperature range	- 55 °C ~ + 90 °C
Moisture resistance	IP67

MATERIALS

Connector bodies	Brass
Male center contact	Bronze / Brass
Female center contact	Bronze
Outer contact	Brass
Other metallic parts	Brass
Insulators	PTFE

PLATING

Bodies	BBR
Outer contact	BBR
Center contact	Silver

Plugs

STRAIGHT PLUGS FOR FLEXIBLE AND SEMI-RIGID CABLES

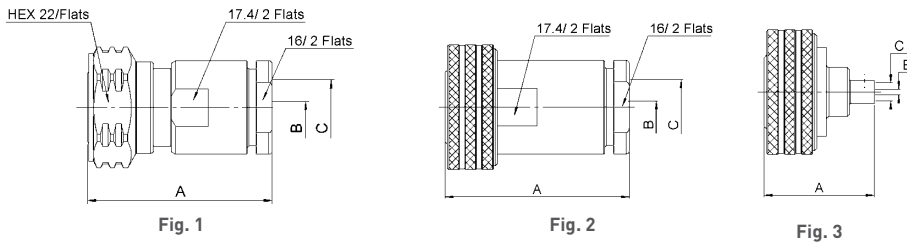

Cable group	Cable group dia.	Part number	Fig.	Dimensions			Captive center contact	Finish	Coupling mechanism	Note
				A	B	C				
RG213 / RG393 / RG214	10+11/50S+D	R183 010 017	1	37.5	2.45	11.20	Yes	Silver + BBR	Screw-on	Clamp
		R183 010 007	2						Push-pull	
RG402 / KS2	.141"	R183 052 007	3	21.9	0.96	3.7			Push-pull	Solder

STRAIGHT PLUGS FOR CORRUGATED CABLES

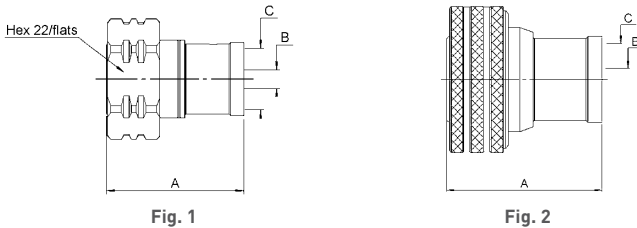

Cable group dia.	Part number	Fig.	Dimensions			Captive center contact	Finish	Coupling mechanism	Note
			A	B	C				
1/2" superflexible corrugated	R183 031 007	1	27.9	3.80	12.55	Yes	Silver + BBR	Screw-on	Solder
1/2" superflexible corrugated	R183 031 017	2						Push-pull	
1/4" superflexible corrugated	R183 030 017	1	23.8	2	6.8	Yes	Silver + BBR	Screw-on	Solder
1/4" superflexible corrugated	R183 030 007	2						Push-pull	
3/8" superflexible corrugated	R183 032 007	1	25.9	2.8	9.45			Screw-on	

RIGHT ANGLE PLUGS FOR HANDFORMABLE AND SEMI-RIGID CABLES

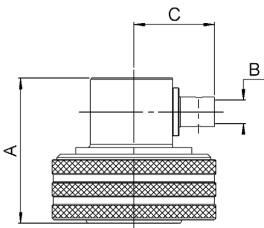

Cable group	Cable group dia.	Part number	Dimensions			Captive center contact	Finish	Coupling mechanism	Note
			A	B	C				
RG402 / KS2	.141"	R183 197 007	21.7	3.65	12.5	Yes	Silver + BBR	Push-pull	Solder

Plugs and Jacks

RIGHT ANGLE PLUGS FOR CORRUGATED CABLES

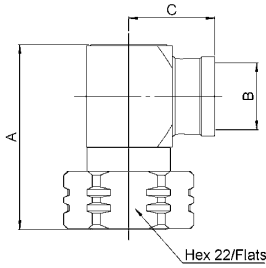

Cable group dia.	Part number	Dimensions			Captive center contact	Finish	Coupling mechanism	Note
		A	B	C				
1/2" superflexible corrugated	R183 165 007	34.7	12.55	16.15	Yes	Silver + BBR	Screw-on	Solder

STRAIGHT SQUARE FLANGE JACKS

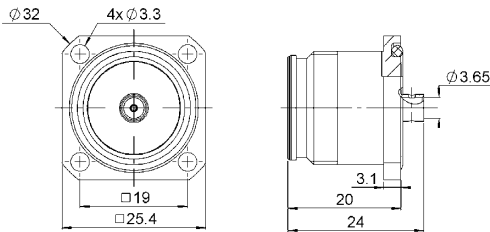

Cable group	Cable group dia.	Part number	Captive center contact	Panel drilling	Finish
RG402	.141	R183 252 007	Yes	P01	Silver / BBR

SQUARE FLANGE JACK RECEPTACLES

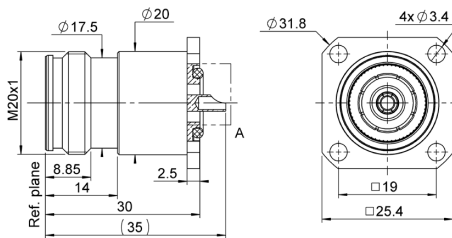

Part number	Captive center contact	Panel drilling	Finish	Note
R183 405 067	Yes	P01	Silver / BBR	Solder pot

Connector Caps

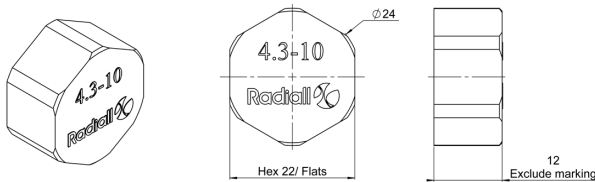

Part number	Note
R183 804 020	IP 67 for mated condition UV resistance

Panel Drilling

P01

PANEL CUT OUT

	mm	
	Maxi	mini
A	7.46	7.3
B	3.6	3.5
C	19.05	18.95

Introduction



50Ω

DC - 6 GHz

GENERAL

- Screw-on coupling mechanism
- High power rating
- 20% smaller & 50% lighter than 7/16
- Low coupling torque
- Low intermodulation

APPLICABLE STANDARDS

- IEC 61169
- MIL PRF 39012

APPLICATIONS

- Telecom
- Medical
- Industrial
- Indoor and outdoor use

Overview

Radiall completes its power connector range with 4.1-9.5, a low intermodulation series. 4.1-9.5 is designed to provide similar performance to 7/16 with smaller size and weight, using a proven screw-on coupling mechanism. With its corrosion resistance, Radiall 4.1-9.5 is the ideal choice for telecom applications where severe conditions require a high performance and robust connector.

HIGH PERFORMANCE

- Impedance 50Ω
- Frequency range DC ~ 6 GHz
- Very low intermodulation level ≤ -125 dBc
- Screw-on coupling mechanism
- Coupling retention force 450 N
- VSWR 1.02 + 0.02 √f
- Meets all requirements for IP67
- High mating life
- Light weight
- Reduced size allows more space for other components
- RF Power: Up to 1000 W @ 1 GHz

Characteristics

Test / Characteristics	Values / Remarks
------------------------	------------------

ELECTRICAL CHARACTERISTICS

Impedance	50Ω
Frequency range	0 - 6 GHz
Typical VSWR	1.02 + 0.02 F
Maximum insertion loss	0.05 √F (GHz)
Insulation resistance	5000 MΩ min
Voltage rating	<=1400 Veff
Dielectric withstanding voltage	<2500 Veff
Contact resistance	≤ 1.5 mΩ
Power	1KW @ 1 GHz
Intermodulation	-160 dBc

MECHANICAL CHARACTERISTICS

Mechanical endurance	100 cycles
Disengagement force	<12 N
Mating torque	1000 N.cm

ENVIRONMENTAL CHARACTERISTICS

Temperature range	- 55 °C ~ + 155 °C
Sealing	IP67

MATERIALS

Connector bodies	Brass
Male center contact	Brass
Female center contact	Beryllium Copper / Bronze
Other metallic parts	Brass
Insulators	PTFE

PLATING

Bodies	BBR2
Outer contact	BBR2
Center contact	Silver

Plugs and Jacks

STRAIGHT PLUGS

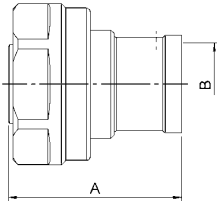

Fig. 1

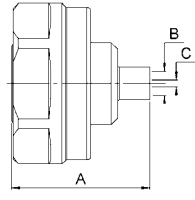

Fig. 2

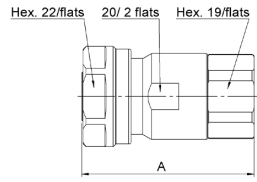
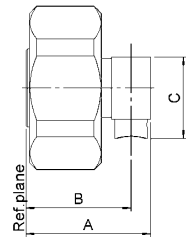
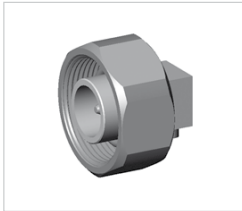

Fig. 3

Cable group dia.	Part number	Fig.	Dimensions			Captive center contact	Finish	Packaging	Note
			A	B	C				
1/2" superflexible corrugated	R170 031 107	1	31.7	12.60	-	Yes	Silver / BBR	50	Solder type
Hand formable cable .141"	R170 031 007	2	22	3.65	1.05				Clamp type
1/2" superflexible corrugated	R170 031 207	3	42	-	-				

RIGHT ANGLE PLUG



Cable group	Cable group dia.	Part number	Dimensions			Captive center contact	Finish	Packaging
			A	B	C			
RG402	Hand formable cable .141"	R170 152 107	19	16.00	12.50	Yes	Silver / BBR	50

SQUARE FLANGE STRAIGHT JACK

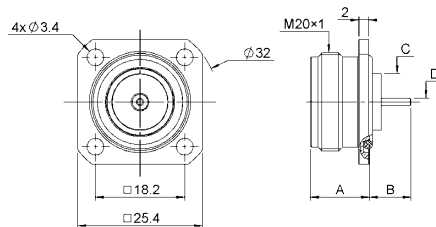
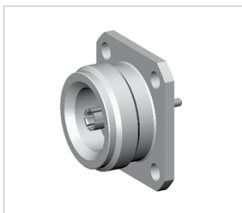

Part number	Dimensions				Captive center contact	Finish	Packaging
	A	B	C	D			
R170 413 127	12	8.50	11.50	1.50	Yes	Silver / BBR	50

NOTE

