



BOARD-TO-BOARD: MMBX/SMP-MAX

R223/R222M

 Section 3 Table of Contents
MMBX

Introduction.....	3-4
Interface.....	3-5
Characteristics	3-6
Plugs	3-7
PCB Receptacles	3-7 to 3-8
Adapters.....	3-9
Demo Board	3-10
Panel Drilling	3-10
Assembly Instructions	3-10

SMP-MAX

Introduction.....	3-11 to 3-12
Characteristics	3-13
Jacks and Plugs	3-14
Receptacles.....	3-15 to 3-16
Adapters.....	3-17 to 3-18
Panel Drilling	3-18

MMBX



50Ω	DC - 12.4 GHz
-----	---------------

INTRODUCTION

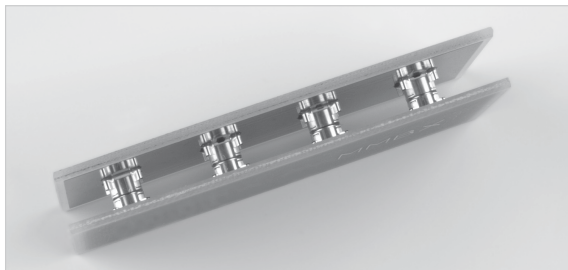
GENERAL

- Snap-on mating
- Microminiature coaxial connectors
- Robust
- Surface mount receptacles
- Fully compatible with automated pick and place machines

APPLICATIONS

- Board to board applications
- Base station
- High density packaging

MMBX™ connector series is particularly suitable for board to board connection in telecommunication systems. MMBX™ connectors allow a quick connection in a minimum space requirement. Frequency range is DC to 12.4 GHz. SMT connectors are totally compatible with pick and place machines.

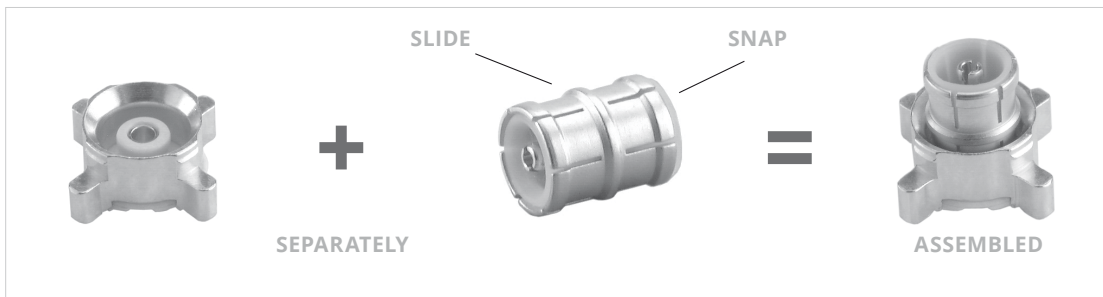


SPACE SAVING

Its small size is a main advantage for applications requiring board to board distance less than 7mm.

RECOMMENDED USE

Receptacles and in-series adapters can be either sold separately or with the adapter already inserted in the receptacle. In this case, assembly time will be reduced and you will be sure that the in-series adapter is properly inserted.



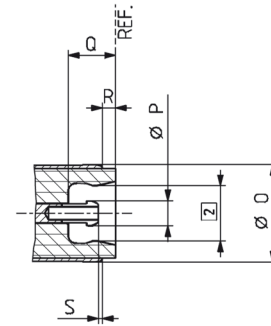
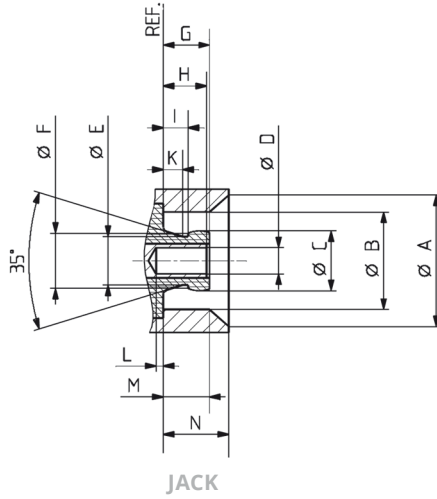
Retention between receptacle and in-series adapter is ensured by the asymmetrical design of the adapter.

- Snap side: for board to board application, it allows all in-series adapters to remain on the same board during disassembly.
- Slide side: it allows quick and easy connections with large axial and radial misalignment tolerance.

MMBX

INTERFACE

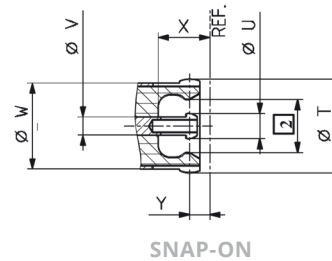
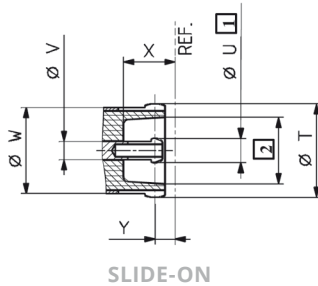
PCB CONNECTORS



LETTER	MM		INCH	
	MIN	MAX	MIN	MAX
A	5.00 NOM	5.00 NOM	.197 NOM	.197 NOM
B	3.68	3.71	.145	.146
C	2.25	2.30	.088	.090
D	0.98	1.01	.038	.040
E	1.85 NOM	1.85 NOM	.073 NOM	.073 NOM
F	2.10 NOM	2.10 NOM	.083 NOM	.083 NOM
G	-	1.80	-	.071
H	1.55	1.75	.061	.069
I	0.90	-	.035	-

LETTER	MM		INCH	
	MIN	MAX	MIN	MAX
K	0.75 NOM	0.75 NOM	.029 NOM	.029 NOM
L	0	-	0	-
M	1.45	-	.057	-
N	2.50 NOM	2.50 NOM	.098 NOM	.098 NOM
O	3.70 NOM	3.70 NOM	.146 NOM	.146 NOM
P	0.95 NOM	0.95 NOM	.037 NOM	.037 NOM
Q	1.85 NOM	1.85 NOM	.073 NOM	.073 NOM
R	0.50 NOM	0.50 NOM	.020 NOM	.020 NOM
S	.010 NOM	.010 NOM	.004 NOM	.004 NOM

IN SERIES ADAPTERS



LETTER	MM	INCH
T	3.70 NOM	.146 NOM
U	0.95 NOM	.037 NOM
V	0.70 NOM	.027 NOM

LETTER	MM	INCH
W	3.65 NOM	.144 NOM
X	2.05 NOM	.080 NOM
Z	0.80 NOM	.031 NOM

Notes

1. Slotted and flared to meet electrical and mechanical requirements
2. Dimension to meet electrical and mechanical requirements

MMBX

CHARACTERISTICS

TEST / CHARACTERISTICS	CECC 22000	VALUES / REMARKS
------------------------	------------	------------------

ELECTRICAL CHARACTERISTICS

Impedance	-	50Ω
Frequency Range	-	DC- 12.4 GHz
Typical V.S.W.R.		DC - 1 GHz 1 - 2.5 GHz 2.5 - 6 GHz
• Straight Connectors:		
- 2/50/S		1.05 1.06 1.10
- 2.6/50/S		1.05 1.06 1.10
- 2.6/50/D	-	1.05 1.06 1.10
• Right Angle Connectors:		
- 2/50/S		1.05 1.13 1.22
- 2.6/50/S		1.05 1.06 1.17
- 2.6/50/D		1.05 1.06 1.13
Insulation Resistance	-	> 1 GΩ
Dielectric Withstanding Voltage (Sea Level)	4.4.5	500 Vrms. 50 Hz 750 Vrms. 50 Hz
• 2.50		
• 2.6/50		
Contact Resistance		
• Center Contact	4.4.2	≤ 5 mΩ
• Outer Contact	4.4.3	≤ 1 mΩ

MECHANICAL CHARACTERISTICS

Mechanical Endurance	4.7.1	100 Matings
Engagement and Separation Force		
• Engagement	4.5.4	30 N max 8-30 N
• Separation		
Contact Captivation	4.5.2	≥ 10 N
Cable Retention Force		
• 2/50	-	58 N
• 2.6/50		110 N
Vibration	4.6.3 - IEC 68-2-6 Fc	MIL-STD-202, Method 204 D, Condition A

ENVIRONMENTAL CHARACTERISTICS

Temperature Range	-	-55 °C + 155 °C
Thermal Shock	4.6.7 - IEC 68-2-14 Na	MIL STD 202, Method 107G, Condition B1
Moisture Resistance	4.6.6 - IEC 68-2-3 Ca	MIL STD 202, Method 106F
Corrosion	4.6.10 - IEC 68-2-11 Ka	MIL STD 202, Method 101, Condition B
Vibration	4.6.3 - IEC 68-2-6 Fc	MIL STD 202, Method 204D, Condition A

MATERIALS

Center & Outer Contacts	-	Beryllium Copper
Bodies	-	Brass
Ferrules	-	Copper
Insulators	-	PTFE

PLATING

Center & Outer Contacts	-	Gold / NPGR
Bodies	-	NPGR
Ferrules	-	NPGR

Notes

Standard packaging = 100 pieces.
All dimensions are given in mm.

MMBX

PLUGS AND PCB RECEPTACLES STRAIGHT PLUGS (MALE CENTER CONTACT)

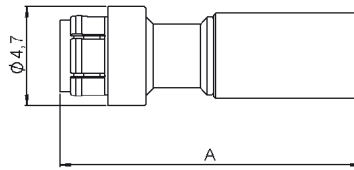
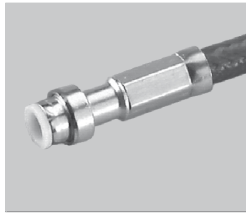


FIG. 1

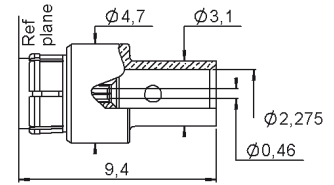


FIG. 2

CABLE GROUP	CABLE GROUP DIA.	PART NUMBER	FIG.	A	CAPTIVE CENTER CONTACT	NOTE
RG178 / RG196	2/50/S	R223 081 000	1	14.3	Yes	Crimp Type for Flexible Cable
RG174 / RG316	2.6/50/S	R223 082 000		14.5		
RG316	2.6/50/D	R223 083 000		-		
RG405	.085"	R223 062 000	2	-		Solder Type for Semi-Rigid Cable

RIGHT ANGLE PLUGS (MALE CENTER CONTACT)

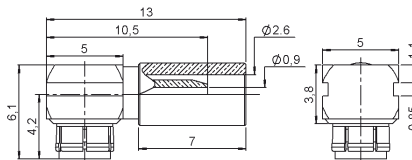
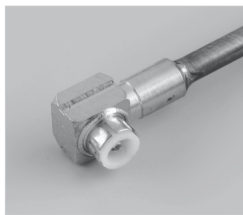


FIG. 1

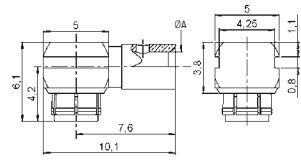


FIG. 2

CABLE GROUP	CABLE GROUP DIA.	PART NUMBER	FIG.	A	CAPTIVE CENTER CONTACT	NOTE
RG178 / RG196	2/50/S	R223 181 000	1	-	Yes	Crimp Type for Flexible Cable
RG174 / RG316	2.6/50/S	R223 182 000		-		
RG316	2.6/50/D	R223 183 000		-		
RG405	.085"	R223 162 000	2	2.275		Solder Type for Semi-Rigid Cable

STRAIGHT PCB RECEPTACLES WITH PRE-ASSEMBLED ADAPTER (MALE CENTER CONTACT)

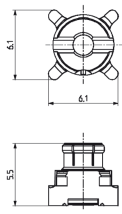


FIG. 1

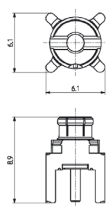


FIG. 2

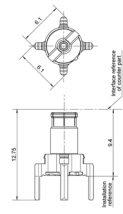


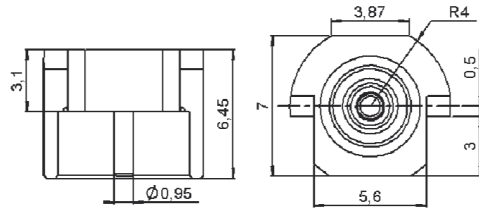
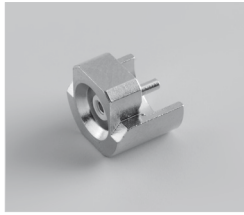
FIG. 3

PART NUMBER	FIG.	CAPTIVE CENTER CONTACT	PCB	ASSEMBLY INSTRUCTIONS	PACKAGING	NOTE
R223 434 000	1	Yes	-	M01	Bulk 100 Pieces	SMT
R223 434 800			-		Tape & Reel 750 Pieces	
R223 435 000	2			P01	-	Bulk 100 Pieces
R223 435 010	3			-		-

MMBX

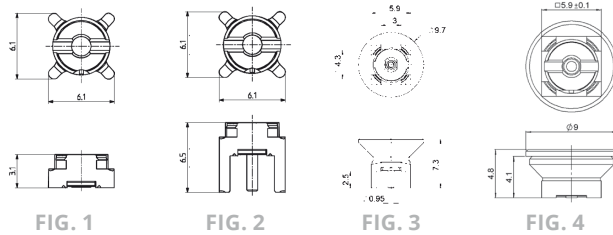
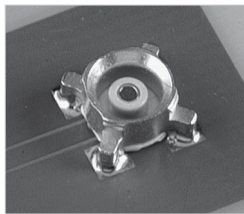
PCB RECEPTACLES

EDGE CARD PCB RECEPTACLES (FEMALE CENTER CONTACT)



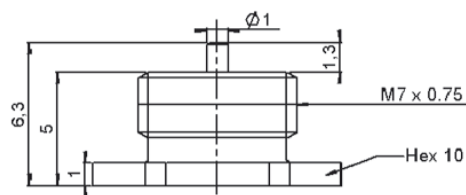
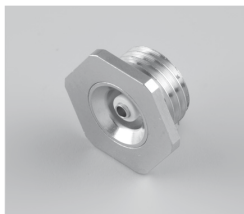
PART NUMBER	CAPTIVE CENTER CONTACT	PACKAGING	NOTE
R223 423 010	Yes	Bulk 100 Pieces	SMT
R223 423 800		Tape & Reel 650 Pieces	

STRAIGHT PCB RECEPTACLES (FEMALE CENTER CONTACT)



PART NUMBER	FIG.	CAPTIVE CENTER CONTACT	PCB	ASSEMBLY INSTRUCTIONS	PACKAGING	NOTE
R223 424 000	1	Yes	-	M01	Bulk 100 Pieces	SMT
R223 424 800				M02	Tape & Reel 750 Pieces	
R223 424 870	4			-	Bulk 100 Pieces	-
R223 425 000	2			-	Tape & Reel 500 Pieces	-
R223 425 800				-	-	Catcher's Mitt
R223 425 810	3			-	-	-

SCREW-ON RECEPTACLE (FEMALE CENTER CONTACT)



PART NUMBER	CAPTIVE CENTER CONTACT	PANEL DRILLING
R223 555 000	Yes	P02

MMBX

ADAPTERS IN SERIES ADAPTERS (MALE-MALE CENTER CONTACT)

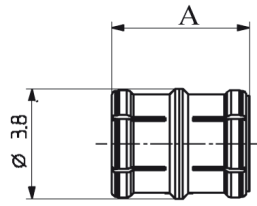
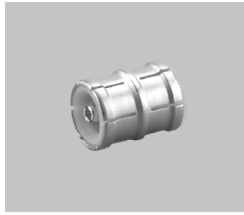


FIG. 1

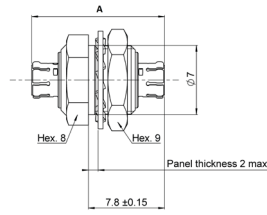


FIG. 2

PART NUMBER	FIG.	LENGTH A (MM)	TYPE	NOMINAL BOARD-TO-BOARD DISTANCE
R223 703 180	1	4.8	Snap-Slide	6.7
R223 703 020		9.7	Slide-Slide	11.7
R223 703 040		12	Snap-Slide M02	14
R223 703 080		7		9
R223 703 230		20.4		22.4
R223 720 020	2	13.6	Slide-Slide Bulkhead	-

BETWEEN-SERIES ADAPTERS

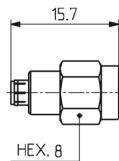


FIG. 1

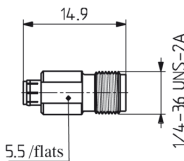


FIG. 2

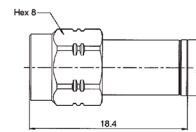


FIG. 3

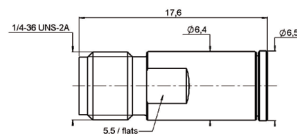


FIG. 4

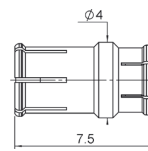


FIG. 5

PART NUMBER	FIG.	SERIES	PACKAGING
R191 389 100	1	MMBX Male / SMA Male	Unit
R191 389 200	2	MMBX Male / SMA Female	
R191 389 300	3	MMBX Female / SMA Male	
R191 389 400	4	MMBX Female / SMA Female	
R191 560 000	5	SMP-MAX Female / MMBX Male Snap	Bulk 100 Pieces

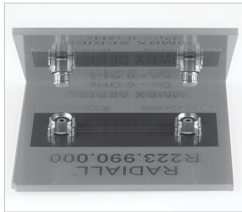
Notes

Other lengths available, please contact us.

Other configurations available, with flange, straight and right angle. Please contact us.

MMBX

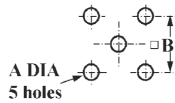
DEMO BOARD



PART NUMBER	NOTE
R223 990 000	2 SMT Receptacles

PANEL DRILLING

P01



	mm		inch	
	maxi	mini	maxi	mini
A	1.4	1.2	.055	.047
B	5.16	5	.203	.197

P02



Threading	
ØA	M7 x 0.75

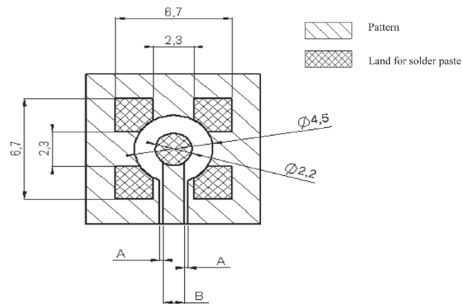
ASSEMBLY INSTRUCTIONS

M01

PART NUMBER					
R223 424 000	R223 424 800	R223 434 000	R223 434 800	R223 435 000	R223 435 010

COPLANAR LINE

- Pattern and signal are on the same side.
- The material of PCB is epoxy resin (FR4) (Er = 4.6).
- The solder resist should be printed except for the land pattern on the PCB.

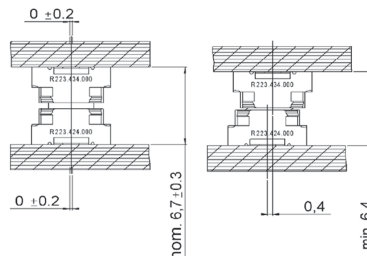
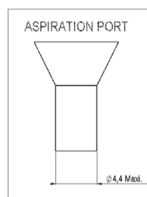
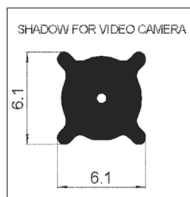


APPLICATION 75Ω WITH B = 0.55 MM

PCB THICKNESS (MM)	COPLANAR LINE A (MM)
0.8	0.350
1.0	0.360
1.2	0.365
1.6	0.375

APPLICATION 50Ω WITH B = 1.2 MM

PCB THICKNESS (MM)	COPLANAR LINE A (MM)
0.8	0.190
1.0	0.200
1.2	0.205
1.6	0.210



Notes

Not valid for R223 424 870, please consult data sheet.

INTRODUCTION

BOARD-TO-BOARD SOLUTIONS



THE BEST SYSTEMS

Radiall's engineers work with your engineers, allowing us to develop the best competitively priced misalignment RF coaxial interconnect solutions on the market today.



THE BEST CHOICES

Radiall offers more board to board choices with four different product groups and ten connector series, that can address the most demanding wireless telecom applications required for the new generation of infrastructure compact equipment. From base stations to repeaters and even handheld and GPS devices, we have a tailored connector solution for you, including the new SMP-MAX, SMP-Spring, IMP-Spring and other large, limited and no misalignment solutions.



**SMP-MAX
RECEPTACLE**

SMP-MAX

Get the best for less with the new SMP-MAX large misalignment solution. Its patented impedance matching insulator is optimized for a larger operating gap between connectors making it easier for engineers to handle a board-to-board distance tolerance of at least .078" (2.0 mm) without a spring, which is 300% more than the standard SMP. It features a 3° minimum tilt (radial travel) and it has an operating frequency range of DC-6 GHz and a 1.2 max VSWR guaranteed at DC-3 GHz.



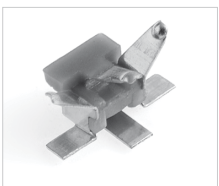
**SMP-MAX
ADAPTER**



**IMP-SPRING AND
SMP-SPRING**

SPRING-LOADED CONNECTORS

Radiall's one connector IMP-Spring and three connector SMP-Spring, MMBX-Spring, and BMR-Spring large misalignment spring-loaded series are the best for increased maximum distance tolerances. IMP-Spring is a cost effective, unique one connector solution that offers up to .023" (.6 mm) board to board distance tolerance with a tilt (radial travel) up to 4.5°. The new SMP-Spring and MMBX-Spring offer up to .078" (2 mm) board-to-board distance tolerance and a 4.5° tilt (radial travel). All spring-loaded solutions feature consistent VSWR and low RF leakage.



IMP

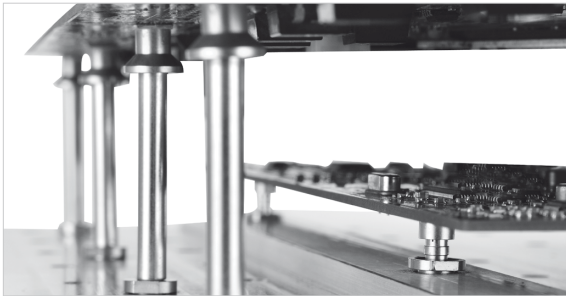
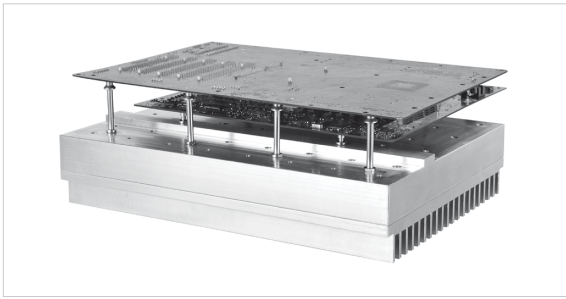
LIMITED MISALIGNMENT

Radiall's one connector IMP and three connector SMP and MMBX limited misalignment series are designed for applications requiring relatively precise distance tolerance of up to .023" (.6 mm) with a tilt (radial travel) of up to 4.5°.

NO MISALIGNMENT

Radiall's MMT, MMS and MCX series are designed for applications requiring little or no distance tolerance between boards.

SMP-MAX



50Ω	DC - 6 GHz
-----	------------

GENERAL

- Microminiature coaxial connectors
- Power up to 300 Watts
- Board-to-Board distance misalignment of at least 0.078" (2.0 mm)
- Tilt (radial misalignment): 3° minimum
- 1.2 max VSWR at DC - 3 GHz

APPLICATIONS

- Broadcast
- RF components (filters, amplifiers,)
- Wireless communications

THE COST-EFFECTIVE SOLUTION FOR MAXIMUM MECHANICAL MISALIGNMENT

Of the several RF connectors available for interconnections in wireless remote radio heads, repeaters, base stations, GPS devices, and similar applications, the Board-to-Board style connector is growing in popularity. The product line has evolved from accommodating limited misalignment to offering the widest tolerances available.

SMP-MAX was introduced by Radiall to provide larger misalignment tolerances than the early version board-to-board connectors like SMP or SMP-spring while offering lower cost.

Featuring an optimized interface, SMP-MAX can work up to 6 GHz Board-to-Board distance misalignment at least 2.0 mm and radial misalignment 3° minimum.

The SMP-MAX series offers 2 levels of retention provided by the receptacles:

- Slide-on, for the lowest retention
- Snap-on, for a positive locking with a retention

A complete SMP-MAX Board-to-Board system is made of 3 parts:



SMP-MAX SLIDE-ON RECEPTACLE



SMP-MAX IN SERIES ADAPTER



SMP-MAX SNAP-ON RECEPTACLE

Many other custom configurations are available. Larger distance misalignment and larger tilt versions are also available.

SMP-MAX

CHARACTERISTICS

TEST / CHARACTERISTICS	VALUES / REMARKS		
ELECTRICAL CHARACTERISTICS			
Impedance	50Ω		
Frequency Range	DC - 6 GHz		
Typical V.S.W.R. (Board-to-Board Connection)	Misalignment	DC - 3 GHz	3-6 GHz
	Radial 0°, Axial 0 mm	< 1.15	< 1.25
	Radial 0°, Axial +/- 1 mm	< 1.20	< 1.35
	Radial 3°, Axial 0 mm	< 1.15	< 1.25
	Radial 3°, Axial +/- 1 mm	< 1.20	< 1.35
Insertion Loss (Board-to-Board Connection)	Misalignment	DC - 3 GHz	3-6 GHz
	Radial 0°, Axial 0 mm	0.10	0.15
	Radial 0°, Axial +/- 1 mm	0.12	0.25
	Radial 3°, Axial 0 mm	0.10	0.15
	Radial 3°, Axial +/- 1 mm	0.12	0.25
Insulation Resistance	5000 MΩ		
Center Contact Resistance	< 3 mΩ		
Outer Contact Resistance	< 1.5 mΩ		
Working Voltage	330 VRMS		
Dielectric Withstanding Voltage	1000 VRMS		
Power Handling (Typical)	> 300W @ 2.7 GHz, 25 °C > 200W @ 2.7 GHz, 85 °C		
RF Leakage	-70dB to 3 GHz, Axial Misalignment 0mm		

MECHANICAL CHARACTERISTICS

Mating Cycles	100 Cycles	
	Slide-On	Snap-On
Engagement Force	< 14 N	< 45 N
Disengagement Force	< 9 N	> 9, < 45 N
Center Contact Retention Force	> 7 N	
Minimum Distance between PCB	13 mm	
Radial Misalignment Tolerance	3° min	
Axial Misalignment Tolerance	2.0 mm Larger Axial Misalignment Version Available	

ENVIRONMENTAL CHARACTERISTICS

Temperature Range	-55 °C / +165 °C
Thermal Shock	MIL-STD-202, Method 107, Condition B
Vibration	MIL-STD-202, Method 204, Condition B
Shock	MIL-STD-202, Method 213, Condition A
Corrosion Salt Spray	MIL-STD-202, Method 101, Condition B
Moisture Resistance	MIL-STD-202, Method 106

MATERIALS

Body	Brass / Beryllium Copper
Male Center Contact	Brass
Female Center Contact	Beryllium Copper
Gasket	Silicon Rubber
Insulator	PTFE / PEEK

PLATING

Body	NPGR / BBR
Male Center Contact	NPGR
Female Center Contact	NPGR

Notes

Standard packaging = 100 pieces box / 500 pieces reel.
All dimensions are given in mm.

SMP-MAX

JACKS, PLUGS AND CABLING

BULKHEAD STRAIGHT SLIDE-ON MALE JACKS FOR CABLES

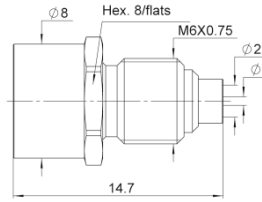


FIG. 1

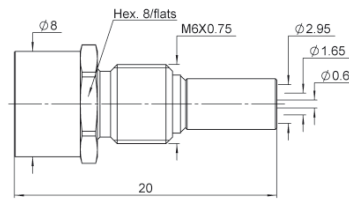
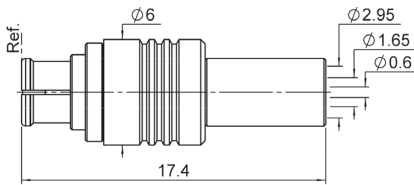


FIG. 2

CABLE GROUP	CABLE GROUP DIA.	PART NUMBER	FIG.	CAPTIVE CENTER CONTACT	PANEL DRILLING	PACKAGING
RG405	.085"	R222 M20 700	1	Yes	P01	Bulk 100 Pieces
RG174 / RG316	2.6/50/S	R222 M20 710	2			

STRAIGHT FEMALE PLUG FOR FLEXIBLE CABLE



CABLE GROUP	CABLE GROUP DIA.	PART NUMBER	CAPTIVE CENTER CONTACT	PACKAGING
RG174 / RG316	2.6/50/S	R222 M80 400	Yes	Bulk 100 Pieces

RIGHT ANGLE FEMALE PLUG FOR FLEXIBLE CABLE

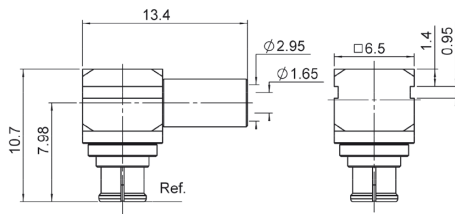


FIG. 1

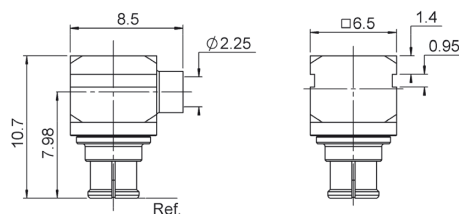
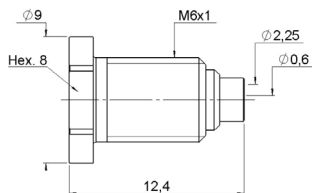


FIG. 2

CABLE GROUP	CABLE GROUP DIA.	PART NUMBER	FIG.	CAPTIVE CENTER CONTACT	PACKAGING
RG174 / RG316	2.6/50/S	R222 M80 500	1	Yes	Bulk 100 Pieces
RG405	.085"	R222 M80 517	2		

BULKHEAD MALE JACK SNAP TYPE



CABLE GROUP	CABLE GROUP DIA.	PART NUMBER	CAPTIVE CENTER CONTACT	PANEL DRILLING	PACKAGING
RG405	.085"	R222 M20 017	No	P05	100

SMP-MAX

RECEPTACLES
STRAIGHT SLIDE-ON MALE RECEPTACLES

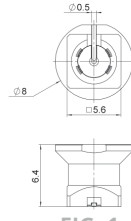
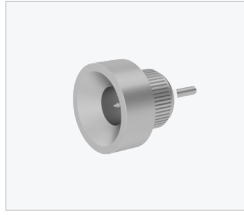


FIG. 1

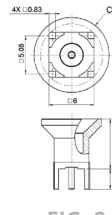


FIG. 2

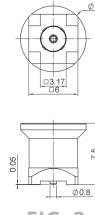


FIG. 3

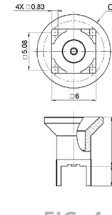


FIG. 4

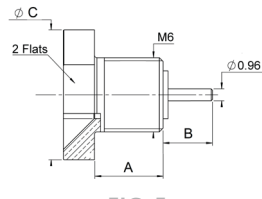


FIG. 5

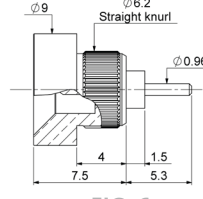


FIG. 6

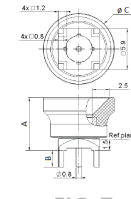


FIG. 7

PART NUMBER	FIG.	DIMENSIONS (MM)			CAPTIVE CENTER CONTACT	PANEL DRILLING	PACKAGING	NOTE	
		A	B	C					
R222 M00 700	1	-	-	-	Yes	-	Tape & Reel 500 Pieces	SMT	
R222 M00 720	2	7.5	1.9	8.3		P02	Bulk 100 Pieces	Solder Legs	
R222 M00 770		8.4	3.4	10		-		Center Contact Dia. 0.95	
R222 M00 730	4	7.7	1.9	8.3		P03	Tape & Reel 400 Pieces	PIH + SMT, with Cap	
R222 M00 740	3	-	-	-		-	Tape & Reel 500 Pieces	SMT	
R222 M10 700	5	5.6	2	9		P01	Bulk 100 Pieces	Screw-On	
R222 M10 730	6	-	-	-		P04		Press In	
R222 M10 750	5	5.6	4	10.5		P01		-	
R222 M00 790	4	13.3	1.9	12		P03		PIH + SMT	
R222 M00 860	2	7.3	3.5	10		P02		Bulk 100 Pieces	Solder Legs
R222 M00 880		7.7	2.4						PIH + SMT
R222 M00 890	4	7.2	1.7			-	500	Composite Catcher's Mitt / SMT	
R222 M03 700	7	7.6	0	10.2		P02	Bulk 100 Pieces	Composite Catcher's Mitt / Solder Legs	
R222 M03 880		7.7	2.4	10					

SMP-MAX

STRAIGHT SNAP-ON MALE RECEPTACLES

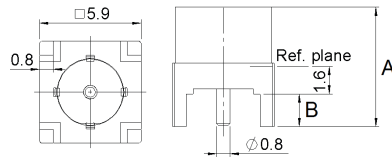


FIG. 1

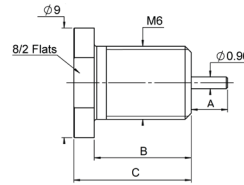


FIG. 2

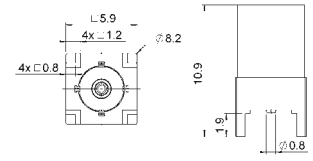


FIG. 3

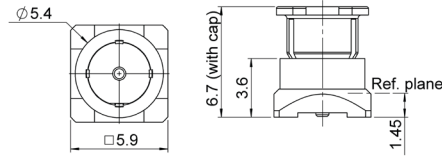


FIG. 4

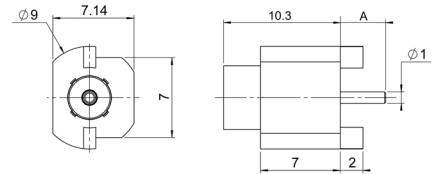


FIG. 5

PART NUMBER	FIG.	DIMENSIONS (MM)			CAPTIVE CENTER CONTACT	PANEL DRILLING	PACKAGING	NOTE
		A	B	C				
R222 M10 000	2	2	7.1	11.15	Yes	P01	Bulk 100 Pieces	Screw-On, with Cap
R222 M10 030		3.5	9.1	11.2				
R222 M10 060		4.1	6.9	8.5				
R222 M00 080	1	7	1.9	-		P02	-	Solder Legs
R222 M00 090	3	-	-	-		P03	Tape & Reel 500 Pieces	PIH + SMT, with Cap
R222 M00 160	1	8.6	3.5	-		P02	-	-
R222 M01 000		6.7	1.7	-		-	Bulk 100 Pieces	Solder Legs
R222 M01 040	3	-	-	-		P03	Bulk 400 Pieces	PIN + SMT
R222 M01 090	5	4	-	-		-	Tape & Reel 500 Pieces	Edge Type
R222 M01 140		3	-	-		-	Bulk 100 Pieces	
R222 M03 000	4	-	-	-	P05	Tape & Reel 500 Pieces	Screw-On	

SMP-MAX

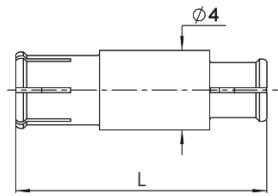
ADAPTERS**IN-SERIES BOARD-TO-BOARD ADAPTERS**

FIG. 1

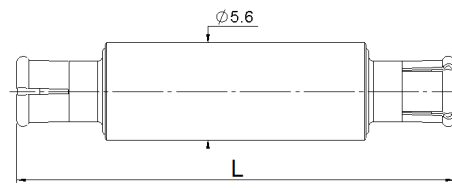
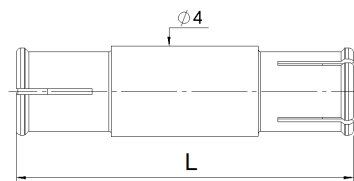


FIG. 2

PART NUMBER	LENGTH L (MM)	FIG.	SERIES	PACKAGING
R222 M40 010	9.5	1	SMP-MAX Female / SMP-MAX Female	Bulk 100 Pieces
R222 M40 050	25.3			
R222 M40 060	12.15			
R222 M40 070	14.9			
R222 M40 080	13.8			
R222 M43 052	25.3	2		
R222 M43 072	14.9			
R222 M43 112	16.7			
R222 M43 192	50.5			
R222 M43 202	45.2			
R222 M43 212	46.25	1		
R222 M43 222	51.15			
R222 M43 262	67.5			
R222 M46 012	9.5			
R222 M46 032	7.2			
R222 M46 047	19.12			
R222 M46 062	12.15			
R222 M46 072	14.9			
R222 M46 102	22.86			
R222 M46 147	15.6			
R222 M46 307	29.39			
R222 M46 317	8.8			

BETWEEN-SERIES BOARD-TO-BOARD ADAPTERS

PART NUMBER	LENGTH L (MM)	SERIES	PACKAGING
R191 996 110	12.6	SMP-MAX Female / SMP Female	Bulk 100 Pieces
R191 996 130	8.9		
R191 560 000	7.5	SMP-MAX Female / MMBX Male Snap	

SMP-MAX

BETWEEN-SERIES ADAPTERS

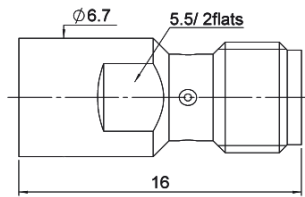


FIG. 1

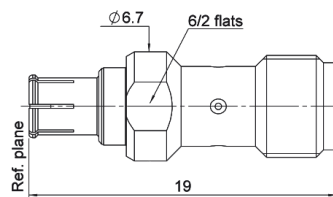
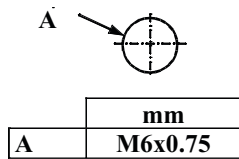


FIG. 2

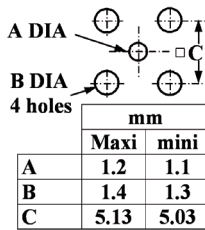
PART NUMBER	FIG.	SERIES	PACKAGING
R191 552 000	1	SMP-MAX Male / SMA Female	Unit
R191 553 000	2	SMP-MAX Female / SMA Female	

PANEL DRILLING

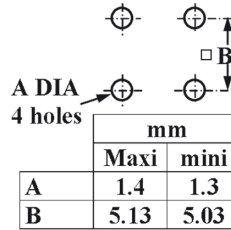
P01



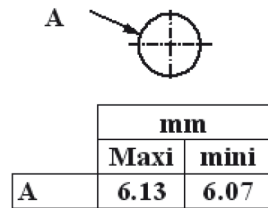
P02



P03



P04



P05

