



## MCX/MMCX/MMS/MMT/MML

R113/R110/R209/R210/R302



Section 1 Table of Contents

**MML**

Introduction..... 1-4  
 Characteristics ..... 1-4  
 Pigtails..... 1-5  
 Cable Assemblies ..... 1-5 to 1-6  
 Receptacles..... 1-6  
 Adapters ..... 1-7

**MMS/MMT**

Introduction..... 1-8  
 Characteristics ..... 1-9 to 1-10  
 Plugs ..... 1-11  
 Pigtails..... 1-11  
 Cable Assemblies ..... 1-11 to 1-12  
 Receptacles..... 1-12  
 Adapters..... 1-12  
 Extraction Tool ..... 1-13  
 Measurement Cable Assemblies ..... 1-13  
 Assembly Instructions ..... 1-13

**MMCX**

Introduction..... 1-14  
 Interface..... 1-14  
 Characteristics MMCX ..... 1-15  
 Characteristics Eco MMCX..... 1-15  
 Plugs ..... 1-16  
 Receptacles..... 1-16 to 1-17  
 Panel Drilling ..... 1-17  
 Assembly Instructions ..... 1-18

**MCX**

Introduction..... 1-19  
 Interface..... 1-19  
 Characteristics ..... 1-20  
 Plugs ..... 1-21 to 1-22  
 Jacks..... 1-22  
 Receptacles..... 1-23 to 1-24  
 In Series Adapters..... 1-24  
 Panel Drilling ..... 1-25  
 Packaging ..... 1-25  
 Assembly Instructions ..... 1-26

MML

## INTRODUCTION

Radiall has developed a new MML series to address the market demand for smaller microminiature coaxial connectors for applications such as cell relay, WiFi access points, GPS and other mobile terminals. There are three types of plugs with mated heights of H2.5, H2.0 and H1.5, as well as two types of vertical PCB receptacles with electrical performance up to 6 GHz.

## FEATURES

- Two vertical PCB receptacles
  - MML H2.5 and MML H2.0
  - MML H1.5
- Space saving
  - Three mated heights 2.5 mm, 2.0 mm, 1.5 mm
  - PCB patterns 3.08 mm x 3 mm for H2.5 and H2.0, 2 mm x 2 mm for H1.5
- DC - 6GHz, typical VSWR 1.35 max
- Cable assemblies are offered with three high performance cables: 1.33 mm for MML H2.5, 1.13 mm for MML H2.0, 0.81 mm for MML H1.5

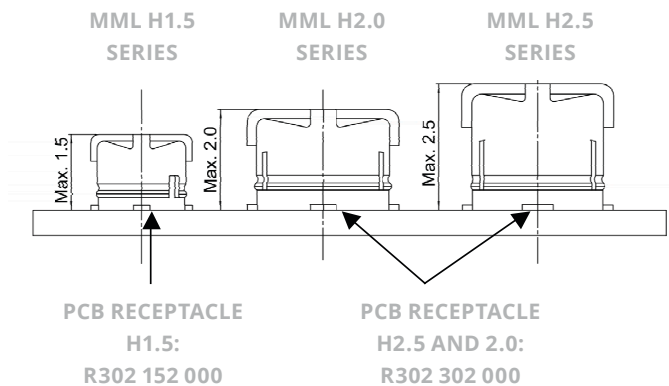

## APPLICATIONS

- Handhelds/GPS/WLAN
- GSM/CDMA/WCDMA/TD-SCDMA cards

## CHARACTERISTICS

TEST / CHARACTERISTICS	VALUES / REMARKS
------------------------	------------------

### ELECTRICAL CHARACTERISTICS

Nominal Impedance	50Ω
Frequency Range	DC - 6 GHz
Typical VSWR	1.35 max
Contact Resistance <ul style="list-style-type: none"> <li>• Center Contact</li> <li>• Outer Contact</li> </ul>	25 mΩ 15 mΩ
Insulation Resistance	500 MΩ min
Voltage Rating <ul style="list-style-type: none"> <li>• H2.5 and H2</li> <li>• H1.5</li> </ul>	200 Vrms 150 Vrms
Withstanding Voltage <ul style="list-style-type: none"> <li>• H2.5 and H2</li> <li>• H1.5</li> </ul>	300 Vrms 200 Vrms
Mechanical Durability	30 cycles
Center Contact Axial Force	0.15 N
RoHS	Compliant
Temperature Range	-40 °C / +90 °C
Humidity	96 hours at Temperature of 40 °C and Humidity of 95%
Corrosion (Salt Spray)	5% Salt Water Solution, 48 hours

### MATERIALS AND PLATING

	Materials	Platings
Connector Bodies	Phosphor Bronze	Gold
Female Center Contact		
Male Center Contact	Brass	

MML

PIGTAILS AND CABLE ASSEMBLIES

MML PIGTAILS

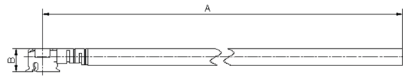

FIG. 1



FIG. 1

CABLE GROUP DIA.	MML TYPE	PART NUMBER	FIG.	DIMENSIONS (MM)	PACKAGING
				A	
1.33/50/S	H2.5	R302 255 003 xxx	1	xxx (500 mm max)	100
1.13/50/S	H2.0	R302 205 001 xxx	2	xxx (400 mm max)	
0.81/50/S	H1.5	R302 155 000 xxx			

MML TO MML CABLE ASSEMBLIES

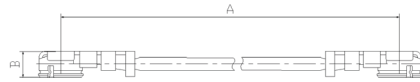
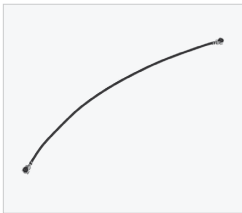

CABLE GROUP DIA.	MML TYPE	PART NUMBER	DIMENSIONS (MM)	PACKAGING
			A	
1.33/50/S	H2.5	R302 000 000 xxx	xxx (500 mm max)	100
1.13/50/S	H2.0	R302 205 000	100	
0.81/50/S	H1.5	R302 155 001		

MML TO MML CABLE ASSEMBLIES

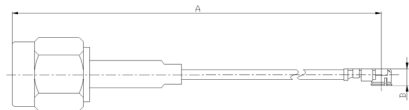

CABLE GROUP DIA.	MML TYPE	PART NUMBER	DIMENSIONS (MM)	PACKAGING
			A	
1.33/50/S	H2.5	R302 255 002 xxx	xxx (400 mm max)	100
1.13/50/S	H2.0	R302 205 002	100	

LENGTH	STEP	TOLERANCE
30 to 100 mm	10 mm	±2 mm
110 to 200 mm		±3 mm
225 to 300 mm	25 mm	±5 mm
325 to 500 mm		±10 mm

Notes

xxx = Length in mm

MML

**CABLE ASSEMBLIES AND RECEPTACLES**  
**MML TO SMA BULKHEAD JACK CABLE ASSEMBLIES**

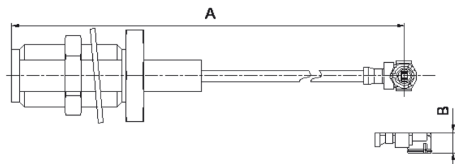

CABLE GROUP DIA.	MML TYPE	PART NUMBER	DIMENSIONS	PACKAGING	NOTE
1.37/50/S	H2.5	R302 255 000 xxx	xxx (400 mm max)	100	-
		R302 255 001 xxx			SMA Panel Seal
1.13/50S	H2.0	R302 255 003 xxx			-
		R302 255 014 xxx			SMA Panel Seal

LENGTH	STEP	TOLERANCE
30 to 100 mm	10 mm	±2 mm
110 to 200 mm		±3 mm
225 to 300 mm	25 mm	±5 mm
325 to 500 mm		±10 mm

**MML TO RP SMA BULKHEAD REVERSE POLARITY CABLE ASSEMBLIES**

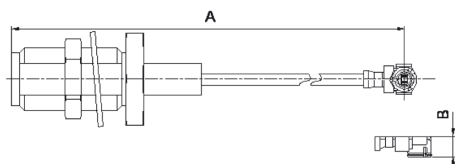

CABLE GROUP DIA.	MML TYPE	PART NUMBER	DIMENSIONS	PACKAGING	NOTE
1.37/50/S	H2.5	R302 255 015 xxx	xxx (400 mm max)	100	-
		R302 255 006 xxx			RP SMA Panel Seal

**SMT RECEPTACLES**

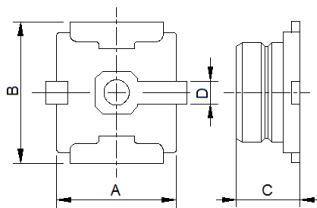

MML TYPE	PART NUMBER	DIMENSIONS				PACKAGING
		A	B	C	D	
H2.5 & H2.0	R302 302 000	2.6	2.6	1.3	0.6	5000 Pieces
H1.5	R302 152 000	1.7	1.7	0.85	0.3	5000 Pieces

**Notes**

xxx = Length in mm

MML

## ADAPTERS AND TEST PROBE

### ADAPTERS

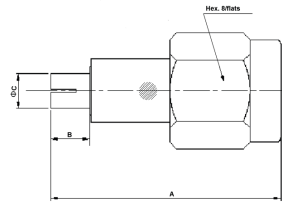

FIG. 1

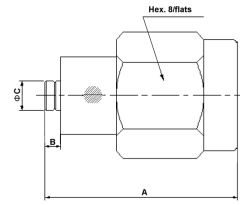
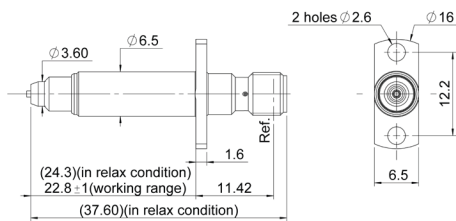

FIG. 2

MML TYPE	PART NUMBER	FIG.	DIMENSIONS			NOTE
			A	B	C	
H2.5 & H2.0	R302 303 000	2	13.2	1.05	1.98	MML Plug - SMA Plug
	R302 303 001	1	17.2	2.9	2.6	
H1.5	R302 153 000	1	17.2	2.9	2.1	MML Jack - SMA Plug
	R302 153 001	2	12.9	0.78	1.4	

### MML TEST PROBE



PART NUMBER	INTERFACE 1	INTERFACE 2
R191 597 800	MML H2.0 / H2.5	SMA Female

## INTRODUCTION

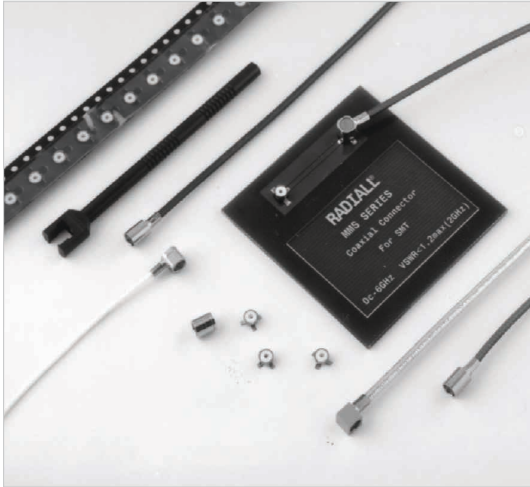

	MMS	MMT
50Ω	DC - 6 GHz	DC - 8 GHz
75Ω	DC - 1 GHz	

### GENERAL

- Low profile coaxial connectors
- Surface-mount receptacle (SMT)
- Snap-on mating
- High RF performance
- 360° cable rotation

### APPLICATIONS

- Automotive
- Satellite reception terminals (GPS...)
- Instrumentation
- Wireless datacom networks
- Automated payment systems
- Video communications
- Other general electronics

Radiall introduced MMS and MMT connectors, dedicated to Surface Mount Technology (SMT), in the 1990s.

MMS and MMT series were the first coaxial connectors truly designed for SMT applications and adapted for automatic pick and place machines.

### • 360° Cable Rotation

The MMS and MMT snap-on mating system ensures a correct positive connection each time and all connectors (plugs + receptacles) have a design which allows a 360° rotation of the pair when mated.

### • MMS vs MMT

MMS and MMT connectors are dedicated to similar applications. The choice between these 2 series will be driven by mating life cycle required for the application. MMS is dedicated to applications which require only a few mating/unmating cycles. MMT provide stronger retention force while allowing more manipulation.

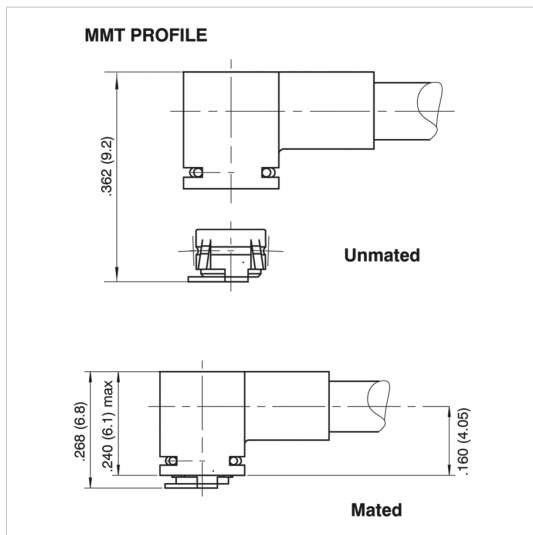
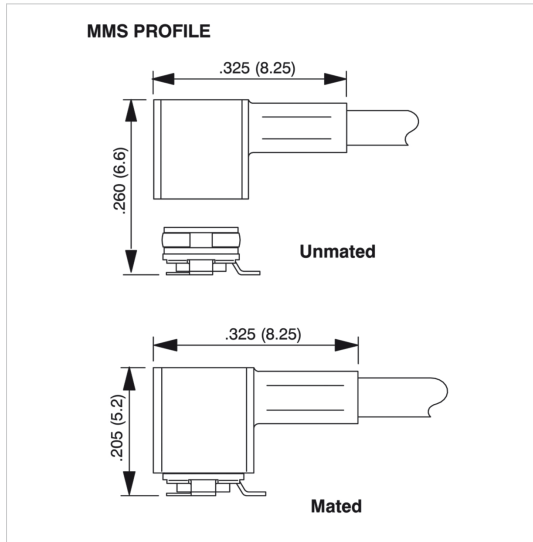

	MMS	MMT
Durability (Mating Cycle)	50	500
Frequency Range	50Ω DC - 6 GHz 75Ω DC - 1 GHz	50Ω DC - 8 GHz 75Ω DC - 1 GHz
Mated Height	5.2 mm	6.8 mm



MMS

## CHARACTERISTICS

TEST / CHARACTERISTICS	TEST STANDARD	VALUES / REMARKS
------------------------	---------------	------------------

### ELECTRICAL CHARACTERISTICS

Impedance	-	50Ω	75Ω
Frequency Range	-	DC - 6 GHz	DC - 1 GHz
Typical V.S.W.R. (Mated Pair)	IEC 1169-1	1.05 at 1 GHz 1.15 at 2.5 GHz 1.35 at 6 GHz	
Insertion Loss	IEC 1169-1	0.2 dB at 2 GHz	
RF Leakage (Mated Pair)	MIL STD 1344 Method 3008	-50 dB at 500 MHz -45 dB at 1 GHz -40 dB at 2 GHz	
Outer Contact Resistance	NF-C 93050 (I = 40 mA peak)	5 mΩ max	
Center Contact Resistance	NF-C 93050 (I = 40 mA peak)	15 mΩ max	
Insulation Resistance	IEC 1169-1	500 MΩ min (under 250 V RMS)	
Working Voltage	-	50 V RMS	
Testing Voltage (V RMS)	IEC 1169-1	Ø 1 mm: 250 ; Ø 2 mm: 500	
Maximum Admissible Power	-	40 W at 1 GHz / 20 °C / V.S.W.R. = 1	

### MECHANICAL CHARACTERISTICS

Durability	IEC 1169-1	50 matings	
Force to Engage	IEC 1169-1	7 N avg	
Force to Disengage	IEC 1169-1	5.5 N avg	
Shocks (Drop Test)	IEC 68-2-27	50 g/11 ms ; 3 shocks / axis / way	
Random Vibrations	General Motors spec.	Sine waves 5 to 1000 Hz 3 to 30g - 1 H/axis	
Bumps (Mechanical Shocks)	IEC 68-2-29	25 g/6 ms 1000 bumps / axis / way	
Cable Retention Force	IEC 1169-1	Ø 1 mm: 20 N ; Ø 2 mm: 35 N	
Solderability	IEC 68-2-54	Passed	

### ENVIRONMENTAL CHARACTERISTICS

Temperature Range	-	-40 °C / +90 °C	
Climatic Cycles	GAM T 13	48 H at 70 °C - 24 H at 40 °C / 93% -36 H at -25 °C	

### MATERIALS

Bodies Plugs/In-Series Adapters	Die Cast Zinc / Brass		
Bodies Receptacles	Phosphor Bronze		
Center Contact	Brass		
• Male	Beryllium Copper		
• Female	PTFE		
Insulator	PTFE		

### PLATING

Bodies Plugs/In-Series Adapters	Nickel
Bodies Receptacles	Gold
Center Contact	Nickel
• Male	Gold
• Female	Gold

### RF LEAKAGE AND V.S.W.R

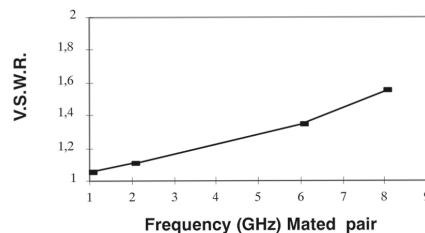
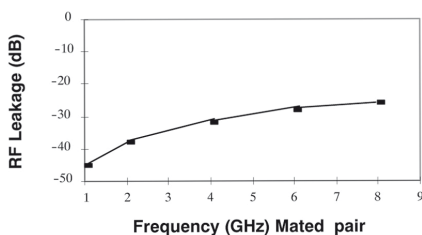

MMT

## CHARACTERISTICS

TEST / CHARACTERISTICS	TEST STANDARD	VALUES / REMARKS
------------------------	---------------	------------------

### ELECTRICAL CHARACTERISTICS

Impedance	-	50Ω      75Ω
Frequency Range	-	DC - 8 GHz      DC - 1 GHz
Typical V.S.W.R. (Mated Pair)	IEC 1169-1	1.05 at 1 GHz 1.10 at 2.5 GHz 1.15 at 6 GHz
Insertion Loss	IEC 1169-1	≤ 0.2 √ F (GHz)
RF Leakage (Mated Pair)	IEC 1726	-42 dB at 500 MHz -38 dB at 1 GHz -30 dB at 3 GHz
Outer Contact Resistance	IEC 1169-1 (I=40 mA eff.)	Initial: 2.5 mΩ max      Final: 12.5 mΩ max
Center Contact Resistance	IEC 1169-1 (I=40 mA eff.)	Initial: 5 mΩ max      Final: 15 mΩ max
Insulation Resistance	IEC 1169-1	≥ 5000 MΩ under 500 Vcc
Working Voltage	-	170 V eff.
Testing Voltage	IEC 1169-1	500 V eff.
Maximum Admissible Power	-	23 W at 1.8 GHz / 40 °C / V.S.W.R. = 1.1

### MECHANICAL CHARACTERISTICS

Durability	IEC 1169-1	500 matings
Force to Engage/Disengage	IEC 1169-1	Ins ≤ 18 N      Ext > 7 N
Shocks	IEC 68-2-27	Passed
Vibrations	IEC 68-2-6	Passed
Bump	IEC 68-2-29	Passed
Cable Retention Force	IEC 1169-1	∅ 2 mm: 20 N ; ∅ 2.6 mm: 60 N
Solderability	IEC 68-2-29	Passed

### ENVIRONMENTAL CHARACTERISTICS

Temperature Range	-	55 °C / 100 °C
Damp Heat	IEC 68-23	Passed
Thermal Shocks	IEC 68-2-14 / Test NA	Passed

### MATERIALS

Plugs Body/In-Series Adaptor	Brass
Receptacles Body	CuSn9p
Plugs Center Contact	Cube2
Receptacles Center Contact	Brass
Insulator	PTFE, Delrin

### PLATING

Bodies Plugs/In-Series Adapters	Nickel / BBR
Bodies Receptacles	Gold
Plugs Center Contact	Gold
Receptacles Center Contact	Gold

### RF LEAKAGE AND V.S.W.R

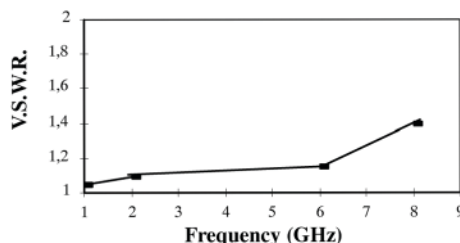
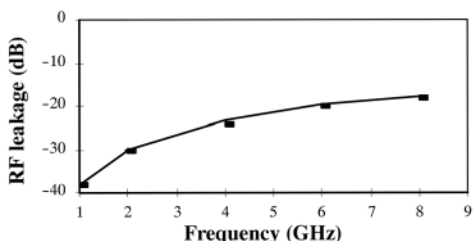

MMS/MMT

## PLUGS, PIGTAILS AND CABLE ASSEMBLIES

### RIGHT ANGLE PLUGS CRIMP TYPE FOR FLEXIBLE CABLES

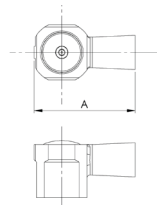
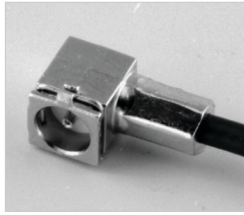

FIG. 1

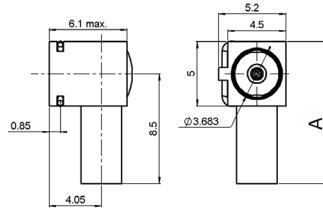

FIG. 2

SERIES	CABLE GROUP	CABLE GROUP DIA.	PART NUMBER	FIG.	IMP. ( $\Omega$ )	DIMENSIONS A (MM)	CAPTIVE CENTER CONTACT	FINISH
MMS	RG178 / RG196	2/50/S	R209 353 000	1	50	8.25	Yes	Nickel
		1/50/S	R209 351 020			7.2		
MMT	RG178 / RG196	2/50/S	R210 160 020	2	50	11		
	RG174 / RG316	2.6/50/S	R210 157 010			10		

### PIGTAILS

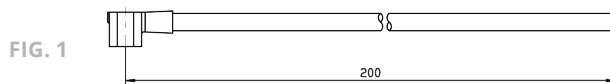
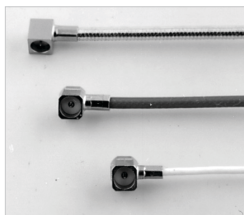

FIG. 1

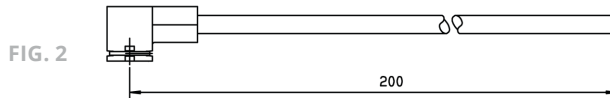

FIG. 2

SERIES	CABLE GROUP	CABLE GROUP DIA.	PART NUMBER	FIG.	COMPOSITION
MMS	RG178 / RG196	2/50/S	R285 001 021	1	R209 353 000 + C291 145 007
MMT	RG178 / RG196	2/50/S	R284 008 001	2	R210 160 020 + C291 145 007
	RG174 / RG316	2.6/50/S	R284 008 004		R210 157 010 + C291 150 000

### CABLE ASSEMBLIES

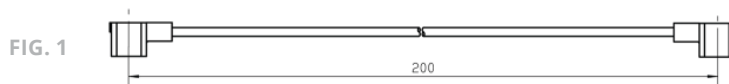
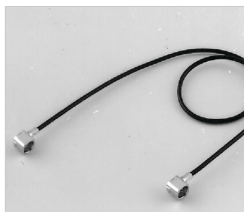

FIG. 1

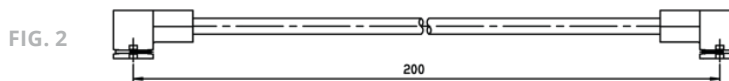

FIG. 2

SERIES	CABLE GROUP	CABLE GROUP DIA.	PART NUMBER	FIG.	COMPOSITION
MMS	-	1/50/S	R285 004 001	1	R209 351 020 + R291 050 066 + R209 351 020
	RG178 / RG196	2/50/S	R285 004 221		R209 353 000 + C291 145 007 + R209 353 000
MMT	RG174 / RG316	2/50/S	R285 011 221	2	R210 160 020 + C291 145 007 + R210 160 020

All dimensions are given in mm.

MMS/MMT

**CABLE ASSEMBLIES, RECEPTACLES AND ADAPTERS**

**CUSTOM CABLE ASSEMBLIES**

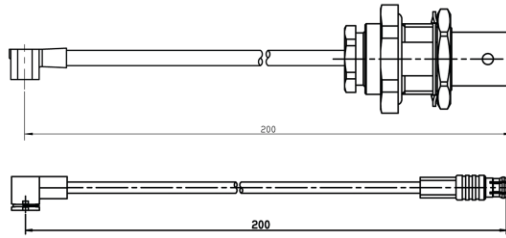
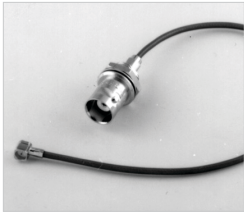

Contact us for all your cable assembly needs.

**SMT RECEPTACLES**

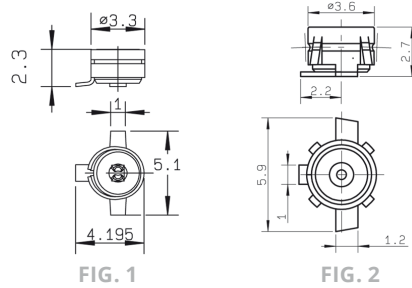
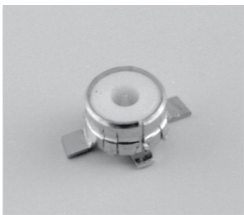

SERIES	PART NUMBER	FIG.	IMP. (Ω)	CENTER CONTACT FINISH	FINISH	PACKAGING	REEL DIA.
MMS	R209 408 012	1	50	Gold	Gold	Tape & Reel 100 pieces	180
	R209 408 052					Tape & Reel 500 pieces	180
	R209 408 302					Tape & Reel 3000 pieces	330
MMT	R210 408 012	2				Tape & Reel 100 pieces	180
	R210 408 052					Tape & Reel 500 pieces	180
	R210 408 302					Tape & Reel 3000 pieces	330

**ADAPTERS**

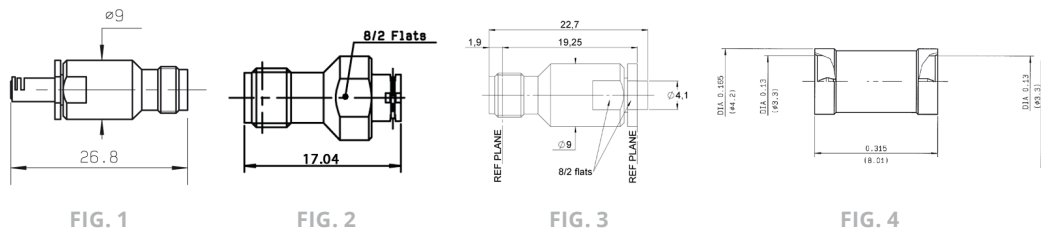
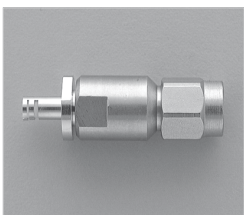

SERIES	PART NUMBER	FIG.	TYPE	FINISH
MMS	R191 975 791	1	MMS Female / SMA Female	Passivated Stainless Steel
	R191 975 781	-	MMS Male / SMA Female	
	R209 703 070	3	MMS Male / MMS Male	Ni
MMT	R191 394 027	2	MMT Female / SMA Female	BBR

MMS/MMT

## MEASUREMENT CABLE ASSEMBLIES AND TOOLING

### MEASUREMENT CABLE ASSEMBLIES

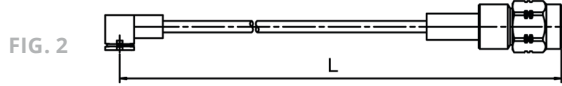
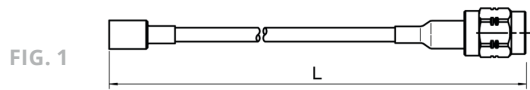

SERIES	CABLE GROUP	CABLE GROUP DIA.	PART NUMBER	FIG.	COMPOSITION	LENGTH L (MM)
MMS <sup>[1]</sup>	RG178 / RG196	2/50/S	R284 007 013	1	R209 080 500 + C291 145 007 + R124 069 120	150
MMT	RD316	2.6/50/D	R284 024 071	2	R210 158 010 + C291 185 067 + R124 072 220	200

### EXTRACTION TOOL <sup>[2]</sup>

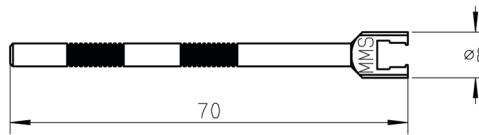
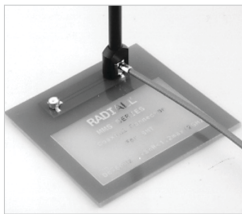

SERIES	PART NUMBER
MMS	R282 868 100
MMT	R282 868 040

### PROCEDURE FOR USE OF SMT NOZZLE FOR RECEPTACLE

Ø OF NOZZLE > 1.2 MM  
SUCTION WITH THE CENTRAL CONTACT HOLE.

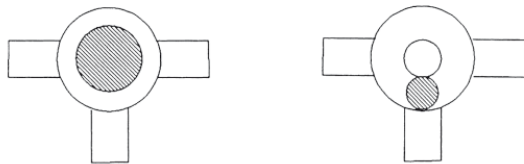

Ø OF NOZZLE < 1.2 MM  
SUCTION WITH INSULATOR.

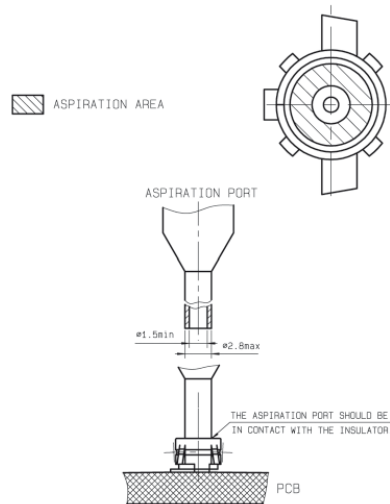

#### Notes

- Both cable assemblies are equipped with a straight MMS plug with a sliding interface to allow 500 matings and a SMA connector.
- Materials and finish; black anodized aluminium. The anodization allows the electric insulation and protects from the oxidization.

MMCX

INTRODUCTION

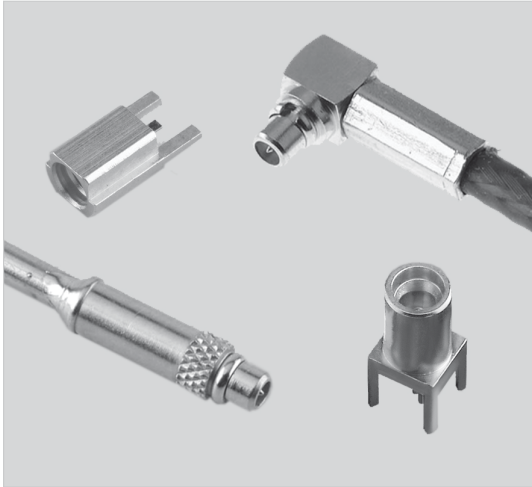

50Ω	DC - 6 GHz
-----	------------

GENERAL

- Subminiature coaxial connectors
- Push-pull snap-on mating
- Complies with specification CECC 22000

APPLICATIONS

- Wireless telecom
- PCMCIA cards
- RF test ports
- Medical

MMCX series is dedicated for wire to PCB connection where low space above the PCB is available (less than 2.1 mm). MMCX is adapted to high volume applications and Pick & Place manufacturing processes.

INTERFACE

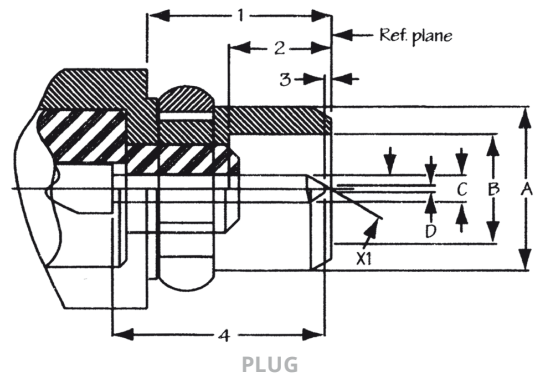
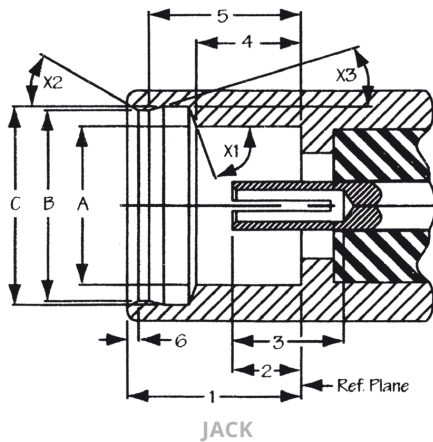

LETTER	MM		INCH	
	MIN	MAX	MIN	MAX
1	2.60	-	.102	-
2	0.90	1.20	.035	.047
3	1.40	-	.055	-
4	1.57	1.63	.062	.064
5	2.30	2.34	.091	.092
6	-	0.23	-	.009
A	2.41	-	.095	-
B	2.88	2.90	.113	.114
C	3.00	3.04	.118	.120
X1	68°	72°	-	-
X2	28°	32°	-	-
X3	13°	17°	-	-

LETTER	MM		INCH	
	MIN	MAX	MIN	MAX
1	2.70	-	.106	-
2	1.45	-	.057	-
3	0	0.25	-	.010
A	2.40	-	.095	-
B	1.58	1.62	.062	.064
C	0.38	0.42	.015	.017
D	-	0.20	-	.008
X1	29°	31°	-	-

MMCX

## CHARACTERISTICS

TEST / CHARACTERISTICS	TEST STANDARD	VALUES / REMARKS
------------------------	---------------	------------------

### ELECTRICAL CHARACTERISTICS

Impedance	-	50Ω
Frequency Range	-	DC - 6 GHz
V.S.W.R.	CECC 22000 4.4.1	Edge Card SMT: 1.40 max Cabled: 1.35 max
Dielectric Withstanding Voltage (At Sea Level)	CECC 22000 4.4.5	500 V RMS 50 Hz
Insulation Resistance	CECC 22000 4.4.4	1000 MΩ min

### MECHANICAL CHARACTERISTICS

Engagement Force	CECC 22000 4.5.4	3.5 lbs max
Disengagement Force	CECC 22000 4.5.4	1.4 lbs to 3.4 lbs max
Contact Captivation	CECC 22000 4.5.2	2.3 lbs min
Durability (Mating)	CECC 22000 4.7.1	500 cycles min

### ENVIRONMENTAL CHARACTERISTICS

Temperature Range	-	-55 °C / +155 °C
Temperature Shock	CECC 22000 4.6.7	Compliant
Vibration	CECC 22000 4.6.3	Compliant

### MATERIALS AND PLATING

	Material	Plating
Bodies	Brass	Gold
Center Contact • Male • Female	Brass Beryllium Copper	Gold
Insulator	PTFE	-

These characteristics are typical and may not apply to all connectors.

## CHARACTERISTICS ECO MMCX

TEST / CHARACTERISTICS	VALUES / REMARKS
------------------------	------------------

### ELECTRICAL AND MECHANICAL CHARACTERISTICS

Impedance	50Ω
Frequency Range	DC - 3 GHz
Typical VSWR	1.35 at 3 GHz
Temperature Range	-40 °C to + 100 °C
Mating Cycles	100 Mating Cycles

### MATERIALS AND PLATING

	Material	Plating
Connector Body	Brass	Gold
Insulator	PTFE / Polypropylene	-
Female Center Contact	Beryllium Copper	Gold
Outer Contact	Brass	-

### PACKAGING

Packaging	100 Pieces Bulk 500 Pieces Reel 1500 Pieces Reel Unit Packaging
-----------	--

MMCX

PLUGS AND RECEPTACLES

STRAIGHT PLUGS

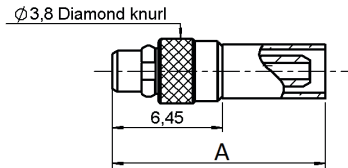

CABLE GROUP	CABLE GROUP DIA.	PART NUMBER	DIMENSIONS A (MM)	PACKAGING	NOTE
RG178 / RG196	2/50/S	R110 081 020	12.45	100	Full Crimp Type
RG174 / RG176	2.6/50/S	R110 083 120	13.35		

RIGHT ANGLE PLUGS

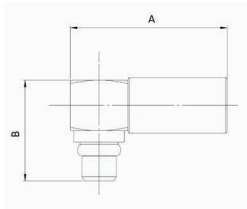
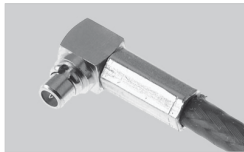

CABLE GROUP	CABLE GROUP DIA.	PART NUMBER	DIMENSIONS (MM)		PACKAGING	NOTE
			A	B		
RG178 / RG196	2/50/S	R110 170 100	10.9	7	100	-
		R110A 170 100	11	9.1	1000	ECO Version
RG174 / RG316	2.6/50/S	R110 172 100	10.9	7	100	-
		R110A 172 100	12.5	8	1000	ECO Version
RG405	.085"	R110 153 000	7	7	100	Solder Type

PCB EDGE CARD RECEPTACLES

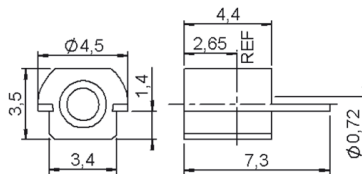

PART NUMBER	GENDER	ASSEMBLY INSTRUCTIONS	PACKAGING	NOTE
R110 422 100	Jack	M03	100	SMT
R110A 422 830			Tape & Reel of 1500 Pieces	ECO Version

STRAIGHT PLUG RECEPTACLES

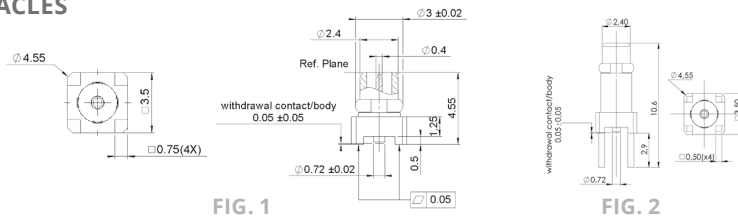

PART NUMBER	FIG.	ASSEMBLY INSTRUCTIONS	PANEL DRILLING	PACKAGING	NOTE
R110 434 100	2	-	P01	100	PCB
R110 434 860	1	M04	-	Tape & Reel of 500 Pieces	SMT



MMCX

## RECEPTACLES AND IN SERIES ADAPTERS

### STRAIGHT JACK RECEPTACLES

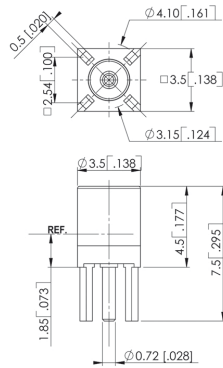
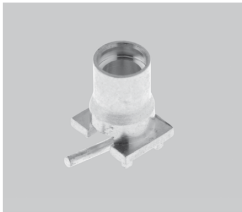

FIG. 1

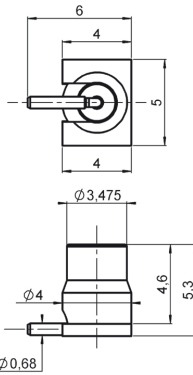

FIG. 2

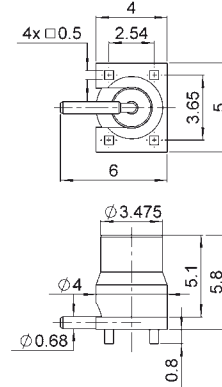

FIG. 3

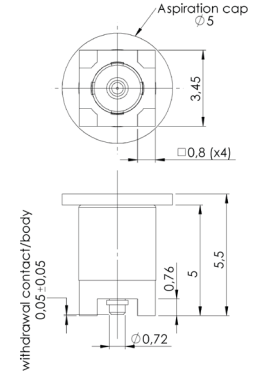
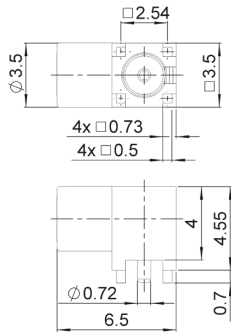

FIG. 4

PART NUMBER	FIG.	PANEL DRILLING	ASSEMBLY INSTRUCTIONS	PACKAGING	FINISH
R110 426 000	1	P01	-	100	Solder Legs
R110A 426 000					ECO Version
R110 427 810	4	-	-	500	SMT
R110 427 820	2	-	M01	Tape & Reel of 500 Pieces	ECO Version
R110A 427 830	3	-	M02		

### RIGHT ANGLE JACK RECEPTACLE



### IN SERIES ADAPTER

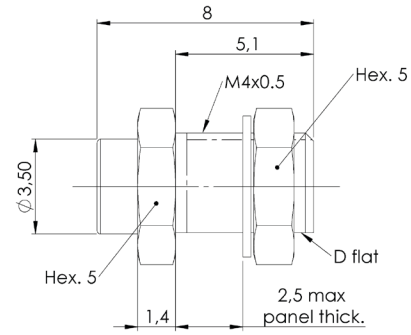

PART NUMBER	PANEL DRILLING	PACKAGING
R110 665 860	P02	500

PART NUMBER	TYPE	FINISH
R110 704 103	Female to Female	Gold

### PANEL DRILLING

P01

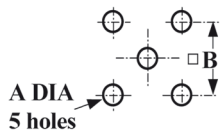

	mm		inch	
	max.	min.	max.	min.
A	0.85	0.75	.033	.030
B	2.56	2.52	.101	.099

P02

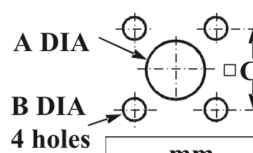

	mm	
	Maxi	mini
A	1.05	0.95
B	0.9	0.8
C	2.56	2.52

MMCX

ASSEMBLY INSTRUCTIONS

M01

SOLDERING PATTERN

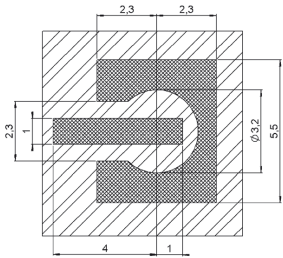

**PART NUMBER**  
R110 427 820

- Ground + varnish
- Lands for solder paste

VIDEO SHADOWS

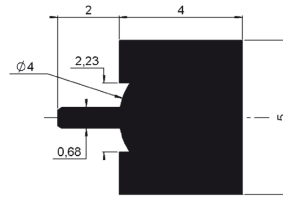

M02

SOLDERING PATTERN

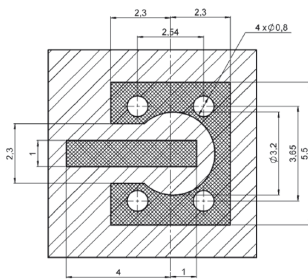

**PART NUMBER**  
R110A 427 830

- Mask + varnish
- Ground + varnish
- Pads to solder
- Lands for solder paste

VIDEO SHADOWS

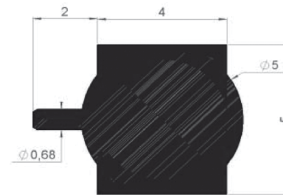

M03

SOLDERING PATTERN

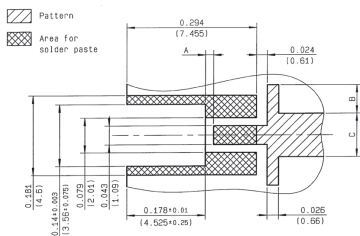

**PART NUMBER**  
R110 422 100  
R110A 422 830

PCB THICKNESS	A	B	C
0.031 (0.79)	0.030 (0.99)	-	0.055 (1.4)
0.030 (0.99)	0.035 (0.89)	0.012 (0.3)	0.071 (1.8)
0.063 (1.6)	0.016 (0.41)	0.063 (1.6)	0.11 (2.79)

VIDEO SHADOWS

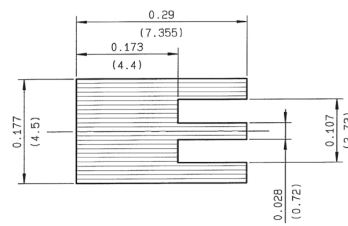

M04

SOLDERING PATTERN

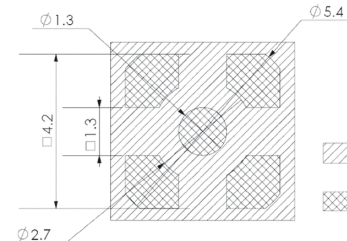

**PART NUMBER**  
R110 434 860

- Pattern
- Land for solder paste

MCX

INTRODUCTION

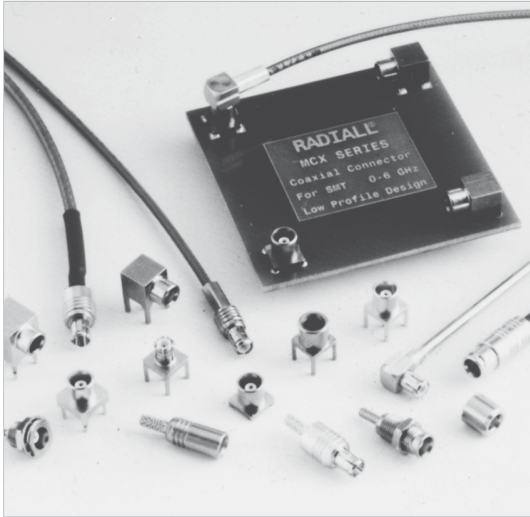

50Ω - 75Ω	DC - 6 GHz
-----------	------------

GENERAL

- Subminiature coaxial connectors
- Push-pull snap-on mating
- Complies with specification CECC 22220
- CEI standard 1169-36

APPLICATIONS

50Ω MODELS

- Wireless communications
- Civil and military radio-telecommunication equipment

75Ω MODELS

- Video communication
- Television broadcasting

The MCX series utilizes the SMB series electrical line and features a particularly simple, compact and robust interface. The MCX series is 30% smaller than the SMB. The MCX series helps to miniaturize equipment. It lowers wiring connection costs through its full crimp and solder crimp versions as the center contact of the straight models can be either crimped or soldered. It optimizes PCB layouts with its range of models for PCBs including surface mount and press-fit receptacles.

INTERFACE

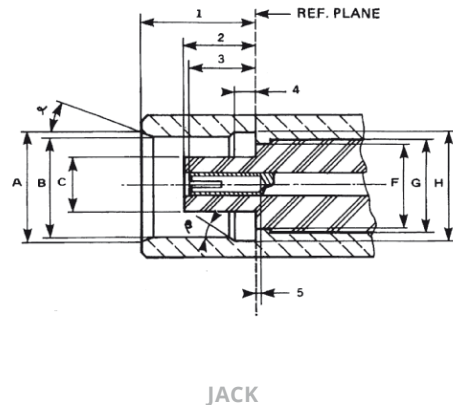
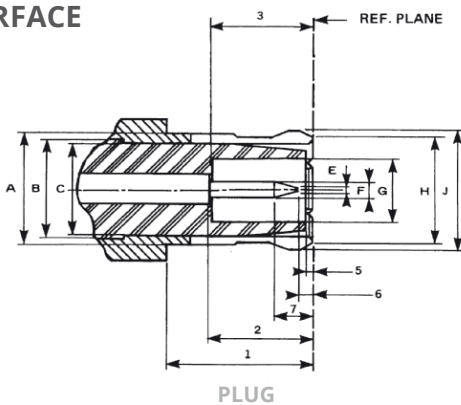

LETTER	MM		INCH	
	MIN	MAX	MIN	MAX
1	4.15	-	.163	-
2	2.80	3.20	.110	.126
3	2.80	-	.110	-
5	0	0.30	0	.012
6	0.15	-	.006	-
7	-	1.20	-	.047
A	-	2.40	-	.134
B	3.05 NOM		.120 NOM	
C	-	3.00	-	.118
E	-	0.25	-	.010
F	0.48	0.53	.019	.021
G	2.00	-	.079	-
H	-	3.60	-	.142
J	-	3.80	-	.150

LETTER	MM		INCH	
	MIN	MAX	MIN	MAX
1	4.00	4.12	.157	.162
2	2.60	2.80	.102	.110
3	2.30	2.80	.090	.110
4	0.75	0.85	.029	.033
5	0	-	0	-
a	18°	22°	18°	22°
β	43°	47°	43°	47°
A	3.80	-	.150	-
B	3.42	3.48	.135	.137
C	-	1.98	-	.078
F	-	3.00	-	.118
G	3.05 NOM		3.05 NOM	
H	3.60	3.75	.142	.148

MCX

## CHARACTERISTICS

TEST / CHARACTERISTICS	VALUES / REMARKS
------------------------	------------------

### ELECTRICAL CHARACTERISTICS

<b>Impedance</b>	50Ω and 75Ω		
<b>Frequency Range</b>	DC - 6 GHz		
<b>Typical V.S.W.R.</b> • Straight styles: .085 2.6/50/S • Sight angle styles: .085 2.6/50/S	1 GHz 1.04 1.06 1.03 1.04	2.5 GHz 1.08 1.09 1.06 1.07	6 GHz 1.13 1.12 1.10 1.10
<b>Insulation Resistance</b>	1,000 MΩ		
<b>Contact Resistance (mΩ)</b> • Center Contact • Outer Contact	Initial ≤ 5 ≤ 2.5	After Environment ≤ 15 ≤ 7.5	
<b>Voltage Rating (V.R.M.R.)</b> • Cable RG 196/U - RG 188A/U - .047" • Ø 2.6 double screen • RG 405/U - .085	At Sea Level 170 V rms max 335 V rms max 250 V rms max	At 70,000 Ft 45 V rms max 85 V rms max 65 V rms max	
<b>Dielectric Withstanding Voltage</b> • Cable RG 196/U - RG 188A/U - .047" • Ø 2.6 double screen • RG 405/U - .085	At Sea Level 500 V rms max 750 V rms max 750 V rms max	At 70,000 Ft 100 V rms max 100 V rms max 100 V rms max	
<b>Power</b>	P = 120W at 1.8 GHz, T = 40°C at sea level, VSWR = 1.1 for a straight plug MCX for [ 2.6/50/D cable		

### MECHANICAL CHARACTERISTICS

<b>Mechanical Endurance</b>	500 Matings
<b>Engagement Separation Force</b>	≤ 14.2 lbs - 63 N max ≥ 1.8 Lbs - 8N ≤ 4.5 lbs 20 N
<b>Cable Retention Force</b> • RG 196A/U • RG 188A/U • Ø 2.6/50 Ω double screen • .047" • RG 405/U-.085	≥ 7.2 lbs - 32 N ≥ 11.9 lbs - 53 N ≥ 24.1 lbs - 107 N ≥ 9.7 lbs - 43 N ≥ 34.9 lbs - 155 N
<b>Contact Captivation</b>	Axial Force 2.25 Lbs 10 N

### ENVIRONMENTAL CHARACTERISTICS

<b>Operating Temperature</b>	-55 °C +155 °C
<b>Temperature Cycling</b>	CECC 22220 Paragraph 4-6-5
<b>Thermal Shocks</b>	CECC 22220 Paragraph 4-6-7
<b>High Temperature Test</b>	CECC 22220 Paragraph 4-7-2
<b>Corrosion (Salt Spray)</b>	CECC 22220 Paragraph 4-6-10
<b>Vibration</b>	CECC 22220 Paragraph 4-6-3

### MATERIALS AND PLATING

	Material	Plating
<b>Bodies and Male Contacts</b>	Brass	Gold / BBR (bodies)
<b>Female Center Contact</b>	Beryllium Copper	Gold
<b>Ferrules</b>	Brass	-
<b>Insulators</b>	PTFE	-

All dimensions are given in mm.  
Standard packaging = 100 pieces

MCX

**PLUGS**

**STRAIGHT PLUGS, FULL CRIMP TYPE, FOR FLEXIBLE CABLES**

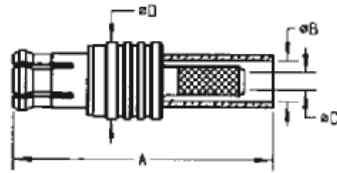
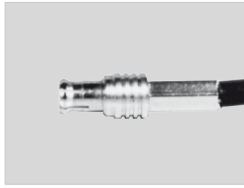

CABLE GROUP	CABLE GROUP DIA.	PART NUMBER	IMP. (Ω)	DIMENSIONS (MM)				CAPTIVE CENTER CONTACT	FINISH
				A	B	C	D		
RG178 / RG196	2/50/S	R113 081 000	50	16.1	2.55	1.1	5	No	Gold
RG174 / RG316	2.6/50/S	R113 082 000		16.1	2.95	1.65			
RD316	2.6/50/D	R113 083 000		16.2	3.25	1.65			
RG179	2.6/75/S	R213 082 007	75	18.2	2.95	1.7	5.8	Yes	BBR
RD179	2.6/75/D	R213 083 007		18.3	3.25				

**STRAIGHT PLUGS, SOLDER TYPE, FOR SEMI-RIGID CABLES**

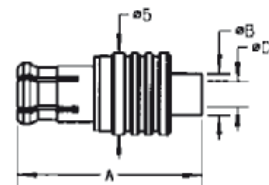

CABLE GROUP	CABLE GROUP DIA.	PART NUMBER	IMP. (Ω)	DIMENSIONS (MM)			CAPTIVE CENTER CONTACT	FINISH
				A	B	C		
RG405	.085"	R113 053 000	50	11.3	3	2.25	No	Gold
UT085-75	.085"/75	R213 053 037	75	14.1	3.1	2.3		BBR

**RIGHT ANGLE PLUGS, CRIMP TYPE, FOR FLEXIBLE CABLES (CAPTIVE CENTER CONTACT)**

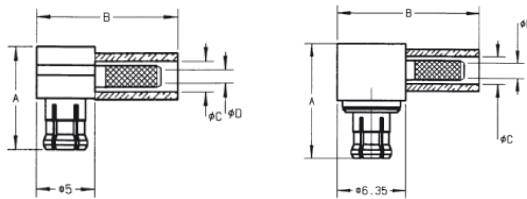
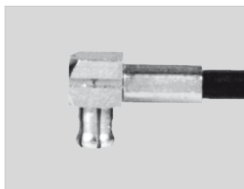

FIG. 1

FIG. 2

CABLE GROUP	CABLE GROUP DIA.	PART NUMBER	FIG.	IMP. (Ω)	DIMENSIONS (MM)				FINISH
					A	B	C	D	
RG178 / RG196	2/50/S	R113 181 000	1	50	8.6	11.9	2.55	1.1	Gold
RG174 / RG316	2.6/50/S	R113 182 000					2.95	1.65	BBR
		R113 182 020			8.2	11.1	3.1	1.7	Gold
RD316	2.6/50/D	R113 183 000					8.6	11.9	3.25
RG179	2.6/75/S	R213 182 007	2	75	10.6	13.3	2.95	1.7	
RD179	2.6/75/D	R213 183 007					3.25		

MCX

## PLUGS AND JACKS

### RIGHT ANGLE PLUGS, SOLDER TYPE (CAPTIVE CENTER CONTACT)

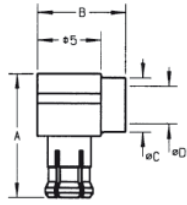
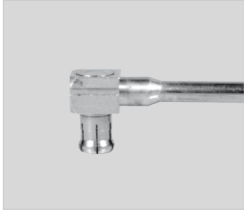

CABLE GROUP	CABLE GROUP DIA.	PART NUMBER	IMP. (Ω)	DIMENSIONS (MM)				FINISH
				A	B	C	D	
.047" Semi-Rigid	.047"	R113 151 000	50	8.6	7	2.1	1.25	Gold
RG405	.085"	R113 153 000				3.1	2.25	
RG178 / RG174 / RG405	2/50/S - 2.6/50/S - .085"	R113 161 000		8	8	3.0	2.35	

### STRAIGHT JACKS, FOR FLEXIBLE AND SEMI-RIGID CABLES

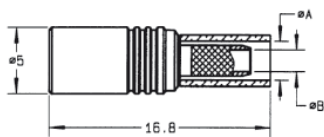

FIG. 1

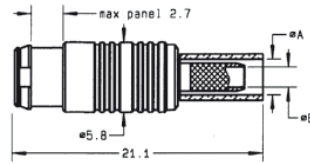

FIG. 2

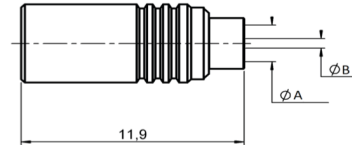

FIG. 3

CABLE GROUP	CABLE GROUP DIA.	PART NUMBER	FIG.	IMP. (Ω)	DIMENSIONS (MM)		CAPTIVE CENTER CONTACT	PANEL DRILLING	FINISH
					A	B			
RG174 / RG316	2.6/50/S	R113 240 000	1	50	2.95	1.65	Yes	-	Gold
RG179	2.6/75/S	R213 238 007	2	75	2.95	1.7		P01	Clip-On Panel Mount
RG405	.085"	R113 223 000	3	50	2.25	0.6	No	-	Gold

### STRAIGHT BULKHEAD JACKS, FOR FLEXIBLE AND SEMI-RIGID CABLES

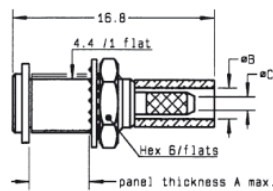

FIG. 1

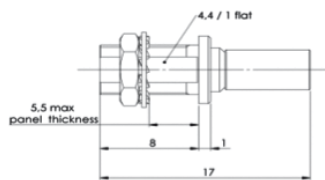

FIG. 2

CABLE GROUP	CABLE GROUP DIA.	PART NUMBER	IMP. (Ω)	DIMENSIONS (MM)			CAPTIVE CENTER CONTACT	PANEL DRILLING	FINISH
				A	B	C			
RG174 / RG316	2.6/50/S	R113 310 000	50	5	2.95	1.65	Yes	P02	Gold
RG178 / RG196	2/50/S	R113 306 000			2.55	1.1	No		
RG405	.085"	R113 303 000			2.25	0.6			
RG174 / RG196	2.6/50/S	R113 312 000		2.95	1.65	Yes			

MCX

## RECEPTACLES

### STRAIGHT FEMALE PANEL RECEPTACLES (CAPTIVE CENTER CONTACT)

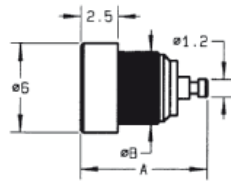

FIG. 1

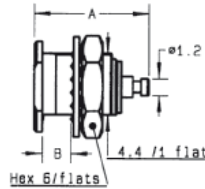
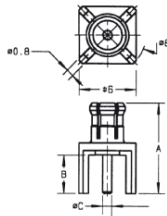

FIG. 2

PART NUMBER	FIG.	IMP. (Ω)	DIMENSIONS (MM)		PANEL DRILLING	FINISH	NOTE
			A	B			
R113 402 220	1	50	8.7	4.8	P03	BBR	Press-In Mount
R113 553 000	2		8.65	2.5	P02	Gold	Recessed Front Mount

### STRAIGHT MALE PCB RECEPTACLES (CAPTIVE CENTER CONTACT)



PART NUMBER	IMP. (Ω)	DIMENSIONS (MM)			PANEL DRILLING	FINISH
		A	B	C		
R113 425 000	50	9.65	4.1	0.98	P04	Gold

### STRAIGHT FEMALE PCB RECEPTACLES (CAPTIVE CENTER CONTACT)

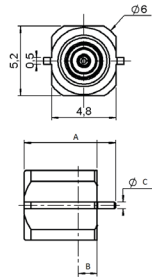

FIG. 1

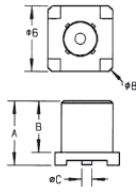

FIG. 2

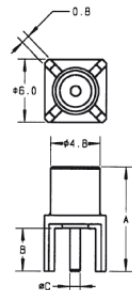

FIG. 3

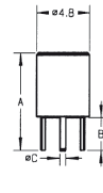

FIG. 4

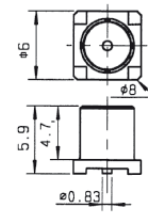

FIG. 5

PART NUMBER	FIG.	IMP. (Ω)	DIMENSIONS (MM)			ASSEMBLY INSTRUCTIONS	PANEL DRILLING	FINISH	NOTE			
			A	B	C							
R113 423 000	1	50	6.9	1.4	0.5	M01	-	Gold	SMT / Edge-Card			
R113 424 000	2		5.9	4.7	0.96				-	-	SMT	
R113 424 010											SMT / Tape & Reel 100 Pieces	
R113 424 020	3		10	4.1	0.98	-	P04	-	-			
R113 426 000									8.44	2.54	0.98	-
R113 426 130									9	3	0.5	-
R113 427 000	4	75	-	-	-	-	Gold	Space Saving on PCB				
R213 424 800	5		-	-	M01			SMT / Tape & Reel 100 Pieces				
R213 426 000	3		10	4.1	0.71			-	-			

MCX

## RECEPTACLES AND IN SERIES ADAPTERS

### RIGHT ANGLE FEMALE PCB RECEPTACLES (CAPTIVE CENTER CONTACT)

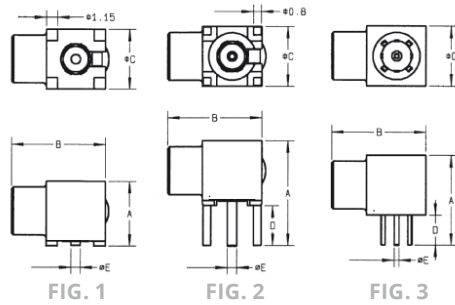
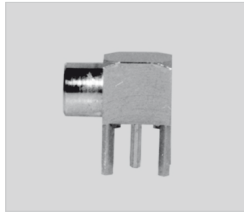

PART NUMBER	FIG.	IMP. ( $\Omega$ )	DIMENSIONS (MM)					ASSEMBLY INSTRUCTIONS	PANEL DRILLING	FINISH	NOTE
			A	B	C	D	E				
R113 664 000	1	50	6.5	9.5	6	-	0.96	M01	-	Gold	SMT
R113 665 000	2		10.5			4		-	BBR	-	
R113 665 020	2		9	9.4		3	0.5	P05	Space Saving Pattern		
R113 666 000	3	75	6.5	9.5	6	-	0.83	M01	-	Gold	SMT / Tape & Reel 100 Pieces
R213 664 800	1		10.5			4		0.83	-	P04	-
R213 665 000	2		10.5	4		0.83	-	P04	-		

### IN SERIES ADAPTER (FEMALE - FEMALE)

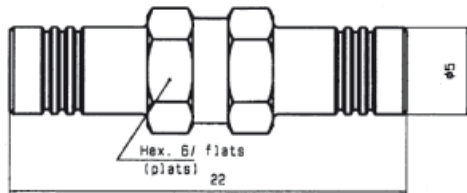

PART NUMBER	IMP. ( $\Omega$ )	FINISH
R113 704 000	50	Gold



MCX

PANEL DRILLING

P01

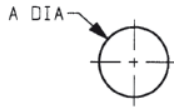

	MM		INCH	
	maxi	mini	maxi	mini
A	5	4.97	0.197	0.196

P02

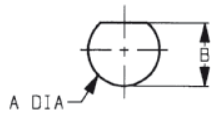

	MM		INCH	
	maxi	mini	maxi	mini
A	5	4.9	0.197	0.19
B	4.58	4.46	0.18	0.176

P03

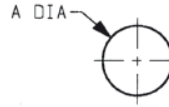

	MM		INCH	
	maxi	mini	maxi	mini
A	4.77	4.74	0.188	0.187

P04

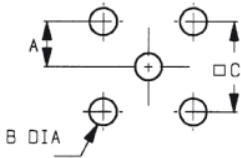

	MM		INCH	
	maxi	mini	maxi	mini
A	2.56	2.52	0.101	0.099
B	1.4	1.3	0.055	0.051
C	5.13	5.03	0.202	0.198

P05

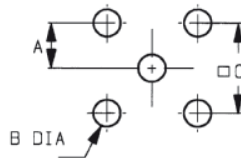

	MM		INCH	
	maxi	mini	maxi	mini
A	1.30	1.24	.051	.049
B	0.89	0.79	.035	.031
C	2.59	2.49	.102	.098

PACKAGING

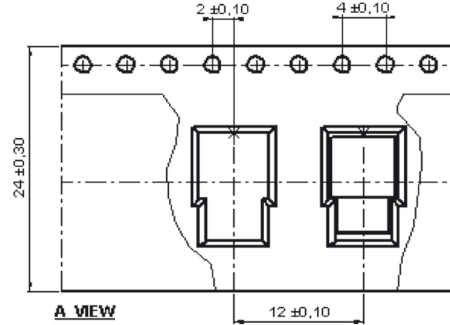
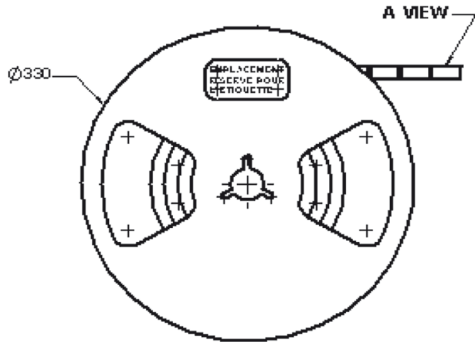

MCX

ASSEMBLY INSTRUCTIONS

M01

PART NUMBER
R113 423 000

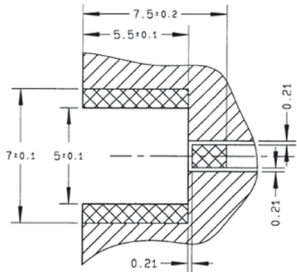

PART NUMBER		a	b	c
R113 424 000 R113 424 010 R113 424 020	R113A 424 020 R113 664 000	$\varnothing 1.7^{+0.1}_0$	1.2	0.21
R113A 664 120			1.2	0.21
R213 424 800		$\varnothing 1.57^{+0.1}_0$	1	0.63

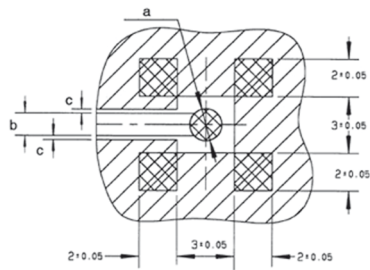

- Pattern
- Land for solder paste

COPLANAR LINE

Pattern and signal are on the same side. Thickness of PCB: .063 (1.6 mm). The material of PCB is the epoxy resin of glass fabrics bacs (Er = 4.8). The solder resist should be printed.

VIDEO SHADOWS

PART NUMBER
R113 423 000

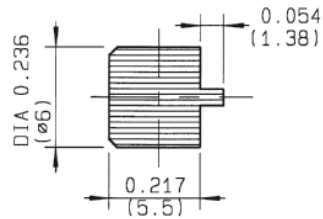

PART NUMBER	
R113 424 000 R113 424 010	R113 424 020 R113A 424 020 R213 424 800

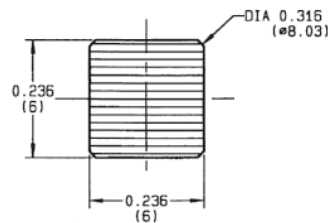

PART NUMBER	
R113 664 000 R113A 664 120	R213 644 800

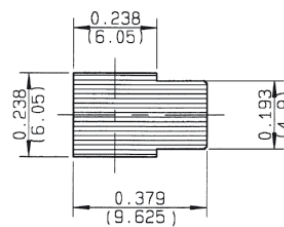

Aspiration nozzle dimensions

