



## MISCELLANEOUS: BR2/TYPE 43/UHF/IMP/UMP

R605/R214/R155/R107



## Section 14 Table of Contents

**TYPE 43**

Introduction.....	14-5
Interface.....	14-5
Characteristics .....	14-6
Panel Drilling .....	14-9

**STANDARD DENSITY**

Plugs .....	14-7
Sockets .....	14-7
Receptacles.....	14-7

**HIGH DENSITY**

Plugs .....	14-8
U Links .....	14-9

**ULTRA HIGH DENSITY**

Plugs.....	14-8
------------	------

**IMP**

Introduction .....	14-10 to 14-11
Full Solderless .....	14-12
Full Solderless Solutions.....	14-13
Characteristics .....	14-14 to 14-15
Board to Board Connectors.....	14-16
Receptacle Packaging .....	14-17
Assembly Instructions.....	14-16

**UMP**

Characteristics .....	14-15
Receptacles.....	14-18
Pigtails.....	14-18
Cable Assemblies.....	14-18
Tools and Accessories .....	14-19
Assembly Instructions.....	14-20

**BR2**

Interface.....	14-21
Characteristics .....	14-21
Plugs .....	14-22
Jacks.....	14-22
Receptacles.....	14-23
Caps.....	14-23
Gasket.....	14-24
Panel Drilling .....	14-24

---

Section 14 Table of Contents

**UHF**

Interface..... 14-25

Characteristics ..... 14-25

Plugs ..... 14-26

Receptacles..... 14-26

Adapter..... 14-26

## Type 43

## INTRODUCTION



75Ω

DC - 3 GHz

## GENERAL

- Standard coaxial connectors
- Reliable lock coupling
- 3 types: Standard Density (12.7mm)
  - High Density (10mm)
  - Ultra High Density (9mm)

## APPLICABLE STANDARDS

- BS9210 F0022

## APPLICATIONS

- Telecom DDF (Digital Distribution Frames)

## INTERFACE

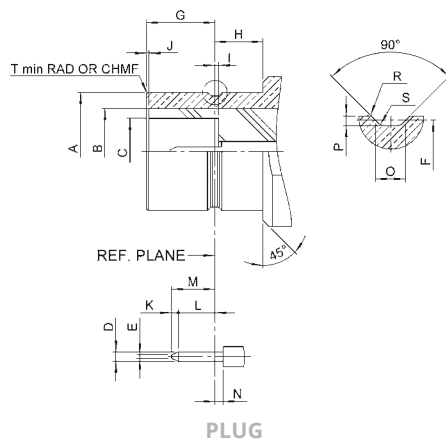

PLUG

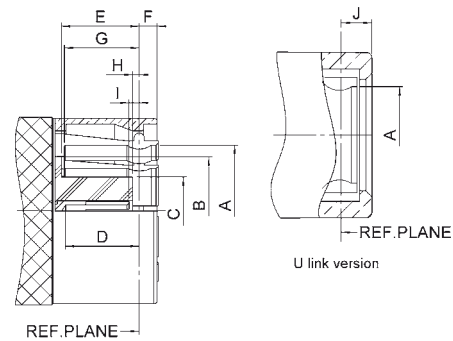

JACK

LETTER	MM		INCH	
	MIN	MAX	MIN	MAX
A DIA	6.20	6.23	.244	.245
B DIA	5.25 NOM		.207 NOM	
C DIA	3.4	3.475	.134	.137
D DIA	0.48	0.52	.019	.02
E DIA	0.125	0.225	.005	.009
F DIA	5.97	6.02	.235	.237
G	3.5	3.55	.138	.14
H	2.4	2.55	.095	.1
I	0.05	0.175	.002	.007
J	0.00	0.10	0.00	.004
K	0.25	0.35	.01	.014
L	1.35	-	.053	-
M	-	2.05	-	.081
N	-	0.18	-	.007
O	0.58 NOM		.023 NOM	
P	0.15	0.25	.006	.01
R	0.05	0.15	.002	.006
S	-	0.13	-	.005
T	0.1	0.2	.004	.008

LETTER	MM		INCH	
	MIN	MAX	MIN	MAX
A DIA	6.31	6.26	.248	.25
B DIA	5.25 NOM		.207 NOM	
C DIA	3.22	3.30	.127	.13
D	3.2	3.53	.126	.139
E	3.63	3.83	.143	.151
F	-	1.8	-	.071
G	3.61	3.77	.142	.148
H	0.23	0.38	.009	.015
I	0.23	0.48	.009	.019
J	1.475	1.97	.058	.078

## Type 43

**TYPE 43 GENERAL TECHNICAL SPECIFICATION**

Radiall 75Ω coaxial Type 43 connectors are designed to meet or exceed the requirements of BS9210 F0022. The following information is subject to change without notice. The performance values shown are typical and may not relate to all connector styles available.

**CHARACTERISTICS**

TEST / CHARACTERISTICS	VALUES / REMARKS
------------------------	------------------

**ELECTRICAL CHARACTERISTICS**

Impedance	75Ω
Frequency Range	DC - 3 GHz
Temperature Range	-40 °C to + 100 °C
V.S.W.R. (Straight Connectors)	1.20 max
V.S.W.R. (Right Angle Connectors)	1.25 max
Voltage Rating	500 Vrms max
Dielectric Withstanding Voltage	1500 Vrms min
Insulation Resistance	5000 MΩ min

**MECHANICAL CHARACTERISTICS**

Durability	250 matings
Cable Retention (Plug Connectors) (Socket Connectors)	60 to 220 N min <sup>[3]</sup>
Center Contact Retention (Plug Connectors) (Socket Connectors)	22 N min
Weight	10 g (grams) typical

**MATERIALS AND PLATING**

Components	Materials	Platings
Body Components <sup>[1]</sup>	Brass	Selective Gold
Outer Contact	Bronze	Selective Gold
Center Contact (Male)	Brass	Gold
Center Contact (Female)	Beryllium Copper	Gold
Insulator	PTFE	N/A
Panel Grommet	Polyacetal	N/A
Ferrule	Brass	Nickel
Panel Mounting Hardware <sup>[2]</sup>	Brass or Phosphor Bronze	Nickel

**Notes**

1. In general all Type 43 series connector bodies are gold plated in mating areas.

As a note, the single piece Type 43 connector body is gold plated in the mating area with other surfaces being nickel coated.

All multi-piece connector bodies comprise of a gold plated front body (mating area) and a nickel plated back body (crimp area).

2. Panel mounting hardware includes components such as - nut, washer, spacer etc.

3. Lower cable retention value for RG179 - 60 N min and BT3002/TZC 75024 - 150 N min

Standard Density

## PLUGS, SOCKETS AND RECEPTACLES

### STRAIGHT SOCKETS CRIMP TYPE FOR FLEXIBLE CABLES

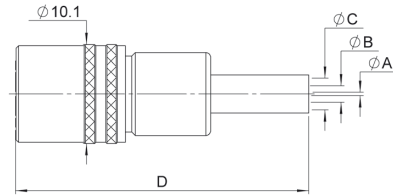
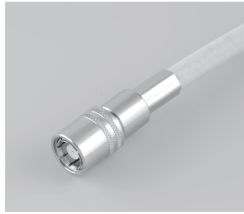

CABLE GROUP	CABLE GROUP DIA.	BT REFERENCE	PART NUMBER	DIMENSIONS				PACKAGING
				A	B	C	D	
BT3002	3.6/75/D	S 43/5 FS	R214 083 922	0.36		4.47	3.2	20 Pieces

### STRAIGHT BULKHEAD RECEPTACLE WITH SOLDER POT

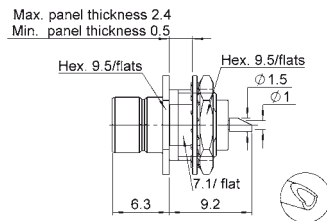

PART NUMBER	PANEL DRILLING	PACKAGING
R214 553 000	P02	Unit

### STRAIGHT PCB PLUG RECEPTACLES

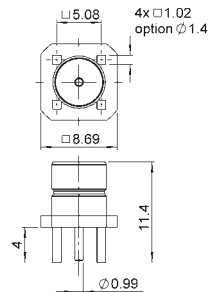

BT REFERENCE	PART NUMBER	PANEL DRILLING	PACKAGING
P 43/1 D	R214 426 704	P01	100 Pieces

High Density and Ultra High Density

## PLUGS

### STRAIGHT PLUGS CRIMP TYPE FOR FLEXIBLE CABLES

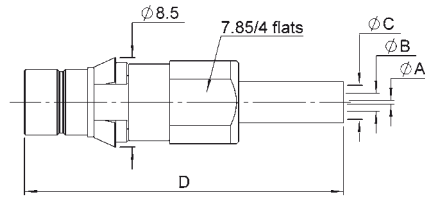
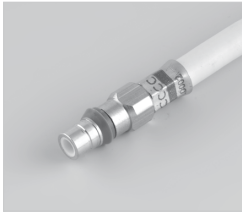

CABLE GROUP	CABLE GROUP DIA.	BT REFERENCE	PART NUMBER	DIMENSIONS				PANEL DRILLING	PACKAGING
				A	B	C	D		
RG179	2.6/75/S	HDC 43/4 GTIS	R214 318 702	0.38	1.73	3.25	3.5	P03	20 Pieces
BT3002	3.6/75/D	HDC 43/5 GTIS	R214 318 722	0.36	2.10	4.47			
RA7000	4.5/75/D	HDC 43/7 GTIS	R214 325 742	0.69	3.00	5.48			

### STRAIGHT SOCKETS CRIMP TYPE FOR FLEXIBLE CABLES

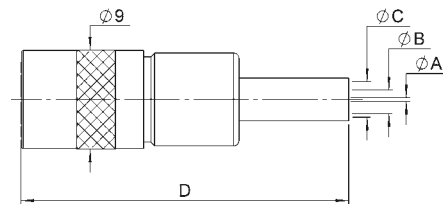

CABLE GROUP	CABLE GROUP DIA.	BT REFERENCE	PART NUMBER	DIMENSIONS				PACKAGING
				A	B	C	D	
RG179	2.6/75/S	HDC 43/4FS	R214 088 902	0.38	1.73	3.25	32	20 Pieces
BT3002	3.6/75/D	HDC 43/5FS	R214 088 922	0.35	2.10	4.47	30	

### STRAIGHT PLUG CRIMP TYPE FOR FLEXIBLE CABLES

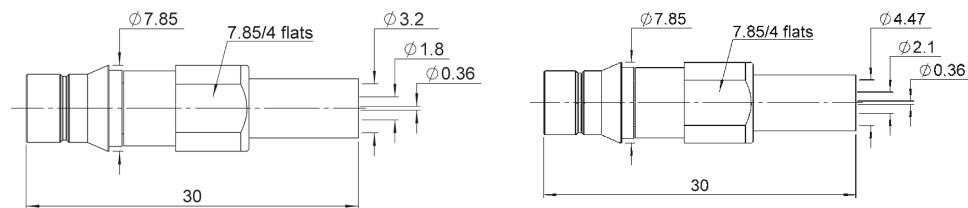

CABLE GROUP	CABLE GROUP DIA.	BT REFERENCE	PART NUMBER	FIG	PANEL DRILLING	PACKAGING
RG179	2.6/75/S	UHDC 43/4 GTIS	R214 320 702	1	P04	20 Pieces
BT3002	3.6/75/D	UHDC 43/5 GTIS	R214 320 722	2		



High Density

U LINKS

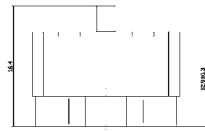
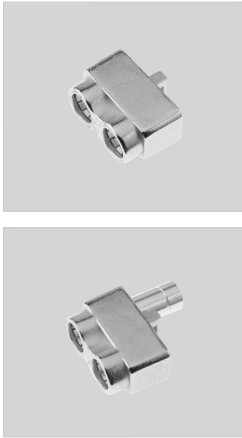

FIG. 1

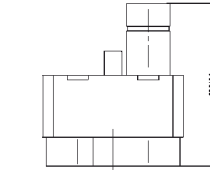

FIG. 2

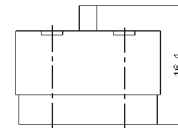

FIG. 3

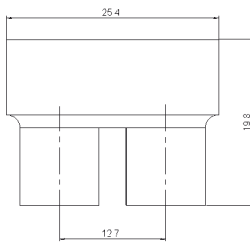

FIG. 4

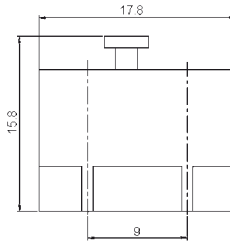

FIG. 5

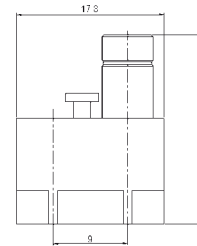
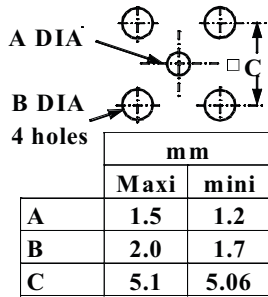

FIG. 6

BT REFERENCE	PART NUMBER	FIG.	PACKAGING
U Link 10A	R214 797 703	1	50 Pieces
U Link 10B	R214 798 703	2	
U Link 13A	R214 790 703	3	
U Link 13B	R214 791 703	4	
U Link 9A	R214 797 723	5	
U Link 9B	R214 798 723	6	

PANEL DRILLING

P01



P02

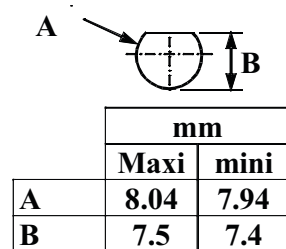

P03

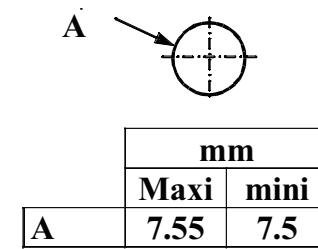

P04

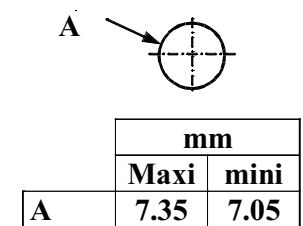

IMP/UMP

**INTRODUCTION**

Radiall introduced the MMP contact technology (Micro Miniature Pressure) in 2001 to meet the needs of the telecommunication industry for ultra low profile and cost effective board connectors. The MMP technology can be found in 2 product lines:

- IMP series: RF Board-to-Board application
- UMP series: RF board to wire application

**BOARD-TO-BOARD APPLICATION**



IMP

**BOARD-TO-BOARD APPLICATION**

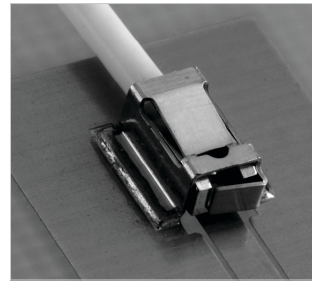

UMP

The IMP series (Interconnect Micro miniature Pressure contact) consists of 1 coaxial connector when usually the same application requires either 2 coaxial connectors (a male SMT receptacle and a female SMT receptacle), or 3 coaxial connectors (2 SMT receptacles and an adapter).

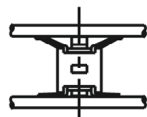

IMP  
One Piece  
Connector

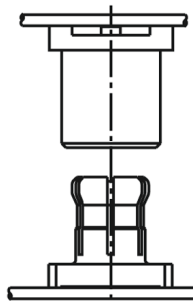

MCX  
2 Coaxial  
Connectors

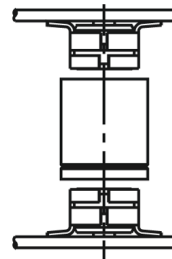

MMS  
3 Coaxial  
Connectors

The UMP series (Ultra Miniature Pressure contact) consists of 1 coaxial plug and 1 SMT edge receptacle.

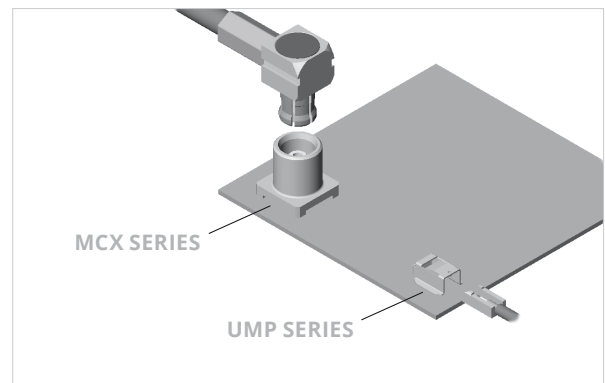

## IMP/UMP

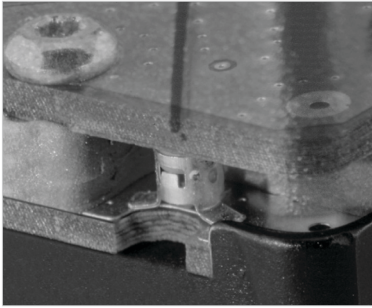
**IMP PRODUCT FEATURES**

- Cost effective solution: one piece connector only
- High density
- Lightweight connector: (example 0.02 g for the IMP 2 mm)
- Low profile for a board-to-board coaxial connections (2 mm)

**IMP INSTALLATION**

The distance between the 2 boards should be precisely measured by a mechanical device (such as spacers).

Contact Radiall for support regarding the layout in your particular application. Application notes are available upon request.

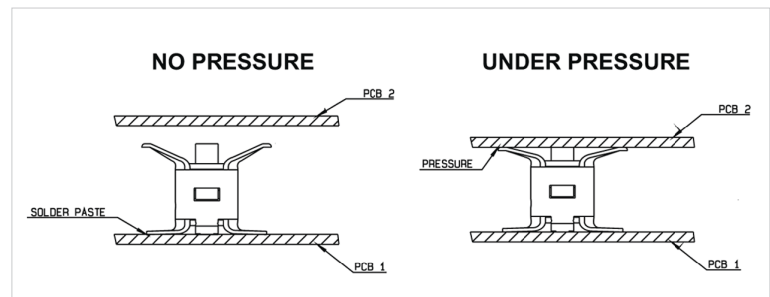
**IMP PRODUCT RANGE**

IMP is available in 2 mm board-to-board distance. Other heights can be developed upon request.

**UMP PRODUCT FEATURES**

- Low profile: 2 mm and 3 mm
- Small space for connection: needs only 2 mm of height
- Cost effective solution: 1 coax connector only
- Large cable range from 0.8 to 2.6 mm
- High durability, up to 10,000 cycles

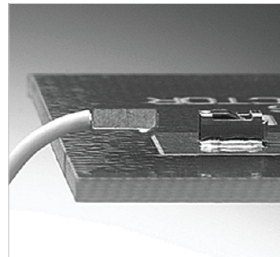
**UMP TYPE OF MATING:**

- Lock: - Can only be disconnected using a tool
  - Number of matings 100
  - Withstands severe vibrations
- Snap-on: - Number of matings 3000
- Snap-on: - Number of matings 10,000
  - For test applications

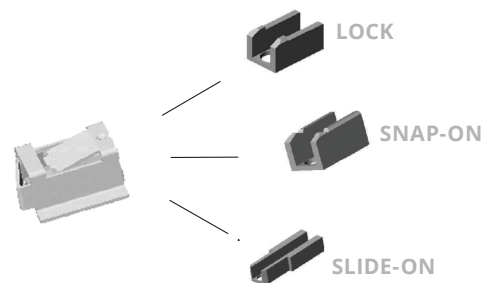

Plug exist with the 3 types of mating:

**APPLICATIONS**

IMP and UMP series can be used for board-to-board and board-to-antenna applications:

- WLAN
- RFID
- Handheld Radios
- Automotive
- GPS Receivers

IMP

**FULL SOLDERLESS**

**IMP FULL SOLDERLESS FEATURES**

- Low profile (Board-to-Board distance: 1.41 mm) and small pitch (IMP diameter: 2.8 mm)
- High frequency range (designed for Ku band applications – up to 20 GHz)
- Designed to work in harsh environments, such as airborne platforms

**IMP FULL SOLDERLESS INSTALLATION**

Most targeted applications for such low Board-to-Board distances or high density integration use a cold plate between Printed Circuit Boards (PCB).

Using this application constraint to receive IMP (to create a cavity) generates a high cost advantage for product integration or maintenance. Its design delivers high performances and signal integrity even in vibration conditions.



**IMP FULL SOLDERLESS RANGE**

IMP Full Solderless Range:

- IMP-LP (Low Profile)
 

The “single model” IMP-LP provides a lower Board-to-Board distance up to 1.41 mm, with an outer diameter of 3.9 mm. To achieve higher Board-to-Board distance (up to 5 mm), Radiall designed a “double model” that provides twice the axial tolerance of the “single model” with the same outer diameter (3.9 mm).
- IMP-HD (High Density)
 

When applications require a high density integration, Radiall offers a smaller product with a diameter of 2.8 mm. As most of those applications require a higher Board-to-Board distance, IMP-HD features a wide axial tolerance up to 1 mm. Low phase noise performance is available upon request.
- IMP-LP “Hybrid”
 

This solderless solution addresses interconnections between two PCBs or a front panel to a PCB. Encapsulating the IMP-LP “double model” into a panel front interface (eg: SMP, SMP-Lock. etc.), this product becomes an IMP-LP Hybrid that combines an interface similar to to IMP-LP’s size and performance. Please contact Radiall for more information on this product family.



**APPLICATIONS**

As designed for applications up to Ku band, the IMP full solderless range is ideal for antennas, radars and seekers.

**ELECTRICAL CHARACTERISTICS**

	IMP-LP	IMP-HD
<b>Impedance</b>	50Ω	
<b>Frequency Range</b>	18 GHz	20 GHz
<b>V.S.W.R.</b>	≤ 1.3 @ 12 GHz    ≤ 1.5 @ 18 GHz	≤ 1.4 @ 18 GHz
<b>Insertion Loss</b>	0.20 dB max	0.15 dB max

**MECHANICAL AND ENVIRONMENTAL CHARACTERISTICS**

	IMP-LP	IMP-HD
<b>Weight</b>	≥ 110 mg	320 mg
<b>Outer Diameter</b>	3.9 mm	2.8 mm
<b>Board to Board Distance</b>	≥ 1.41 mm	Typ. 13.4 mm
<b>Operating Temperature</b>	-55/+125 °C	
<b>Vibrations</b>	MIL STD 810 G	

IMP

FULL SOLDERLESS SOLUTIONS

IMP-LP

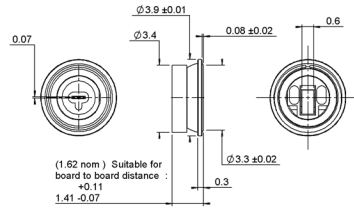

FIG. 1

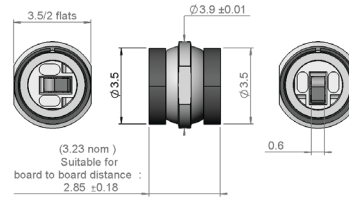

FIG. 2

PART NUMBER	FIG.	BOARD TO BOARD DISTANCE (A)
R107 802 000	1	1.41 mm
R107 803 000	2	2.85 mm
R107 803 020	2	3.10 mm

For information on other Board-to-Board distances, please contact Radiall.

IMP-HD

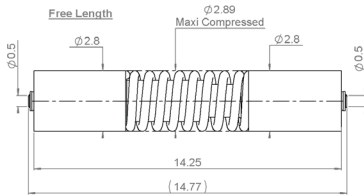

FIG. 1

PART NUMBER	FIG.	BOARD TO BOARD DISTANCE (A)	REMARK
R107 064 930	1	13.4 mm	-
R107 064 944	1	13.4 mm	-

IMP-LP HYBRID



PART NUMBER	FRONT INTERFACE
R107 820 300	SMP-LOCK
R107 820 310	SMP Smooth Bore
R107 851 000	MCC#12

IMP-LP HYBRID EDGE RECEPTACLE

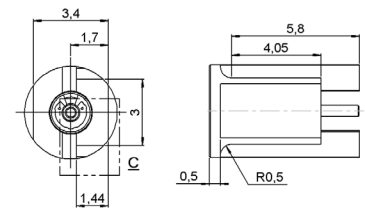

FIG. 1

PART NUMBER	FIG.	REMARK
R107 830 000	1	Compatible with R107 820 300/R107 820 310/R107 851 000

IMP

## CHARACTERISTICS

TEST / CHARACTERISTICS	VALUES / REMARKS
------------------------	------------------

### ELECTRICAL CHARACTERISTICS

	IMP LP	IMP HD
Impedance	50Ω	
Frequency	0-18 GHz	0-20 GHz
V.S.W.R.	+ 0.0000 x F (GHz) Maxi	
Insertion Loss	0.2 dB Max	0.2 F(GHz) dB Max
RF Leakage	-	
Voltage Rating	225 Veff Max	
Dielectric with Standing Voltage	500 Veff Max	
Insulation Resistance	1,000 MΩ min	

### MECHANICAL CHARACTERISTICS

	IMP LP	IMP HD
Cable Contact Retention • Axial force - Mating End • Axial force - Opposite End	0.5 N mini 0.5 N mini	10 N mini 10 N mini
Mating Life	50 Cycles mini	
Nominal Weight	0.1600 g	0.3800 g
Minimum Compression	Typ.5N	Overall length: L = 13.9 Maxi Load = 4.5 N min
Maximum Compression	Typ.5N	Overall length: L = 12.9 mini Load = About 10 N Max

### ENVIRONMENTAL CHARACTERISTICS

	IMP LP	IMP HD
Operating Temperature	-55/+125 °C	-65/+165 °C
Hermetic Seal	NA Atm.cm3/s	
Panel Leakage	NA	

### MATERIALS

	IMP LP	IMP HD
Body	Bronze	Beryllium Copper
Center Contact	Beryllium Copper	
Insulator	Peek	
Other Parts	Beryllium Copper	Steel

### PLATING

	IMP LP	IMP HD
Body	NPGR	NPGR
Center Contact	Gold	Gold

IMP/ump

## CHARACTERISTICS

TEST / CHARACTERISTICS	VALUES / REMARKS
------------------------	------------------

### ELECTRICAL CHARACTERISTICS

	IMP	UMP
Impedance	50Ω	
Frequency	DC - 6 GHz	
V.S.W.R. Max	1.3	1.05 + 0.03F (mated connectors)
Insertion Loss (dB)	0.2 √F (GHz)	
RF Leakage	-40dB min at 2 GHz	
Insulation Resistance	3000MΩ	1000MΩ min
Contact Resistance (depending on PC board) • Center Contact • Outer Contact	60 mΩ 10 mΩ	
Working Voltage	100 VRMS	
Dielectric Withstanding Voltage	350 VRMS	
Power at Sea Level, at 20 °C	20 W (at 3 GHz)	50 W (at 1.8 GHz)

### MECHANICAL CHARACTERISTICS

Durability	> 20	- Lock: 100 - Snap-on: 3000 - Slide-on: 10,000
Weight (g)	0.02	- Receptacle: 0.03 - Plug: 0.08
Axial Misalignment from Nominal Board to Board Distance in mm (inch)	±0.2 (.008)	N/A
Radial Misalignment in mm (inch)	-	N/A
Force to Engage	-	5N
Cable Retention Force	-	20N - 100N
Sine Vibrations	-	IEC 68-2-6
Random Vibrations	-	IEC 68-2-36
Shocks	-	IEC 68-2-29
Retention on Test Board	-	20N min

### ENVIRONMENTAL CHARACTERISTICS

Temperature Range	-40 / +90 °C
-------------------	--------------

### MATERIALS

Body/Outer Contact	Beryllium Copper	- Plug: Brass - Receptacle: Beryllium copper
Center Contact		Brass (plug only)
Insulator	Polyethercetone	PTFE

### PLATING

Body	Gold
Center Contact	

IMP

## BOARD-TO-BOARD CONNECTORS

### SMT CONNECTORS

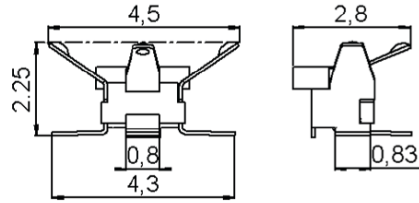

PART NUMBER	HEIGHT (MM)	PACKAGING	REEL DIMENSIONS A (MM)	ASSEMBLY INSTRUCTIONS
R107 064 080	2	Reel of 3500	330	M01
R107 064 070		Reel of 100	180	

## ASSEMBLY INSTRUCTIONS

M01

### SOLDERING PATTERN

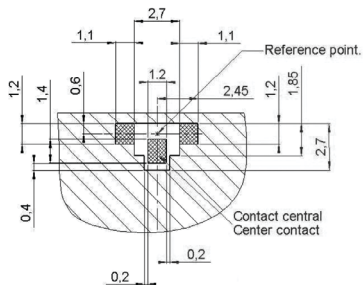

PART NUMBER
R107 064 080

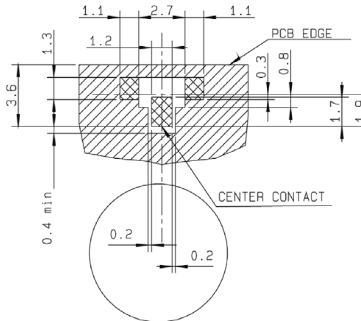

PART NUMBER
R107 064 070
R107 064 080

- Metallization
- Land for solder paste (area free of varnish)

### CONTACT PATTERN

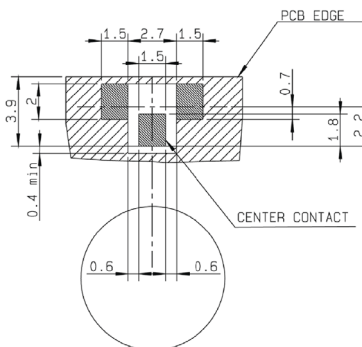
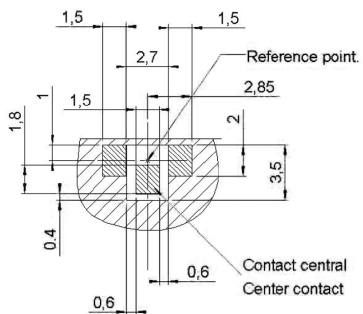

- Metallization
- Contact area (area free of any surface contaminant)

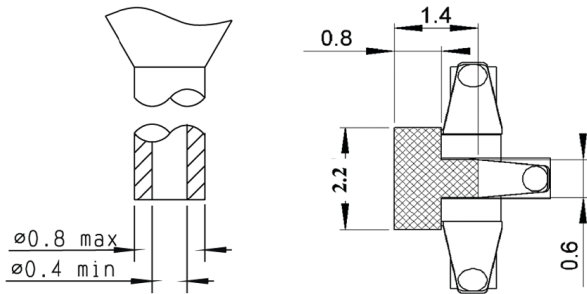

IMP

**RECEPTACLE PACKAGING****PROCEDURE FOR USE OF SMT NOZZLE FOR RECEPTACLE****IMP H2**

The following pick and place equipment and associated nozzles were successfully tested for the IMP:

A) FUJI: QP-242/MODULE TYPE

QP-242 IMP MOUNT MODULE NAME: TYPE BI-612

IMP NOZZLE PART N°: I-S12B-013-100 (NOZZLE PIE 1.3)

B) PANASONIC: MSF type machine

NOZZLE PART N°: 10 807 GH 810

For other equipment, please contact your supplier to define equivalent nozzles.

UMP

## RECEPTACLES, PIGTAILS AND CABLE ASSEMBLIES

### SMT RECEPTACLES

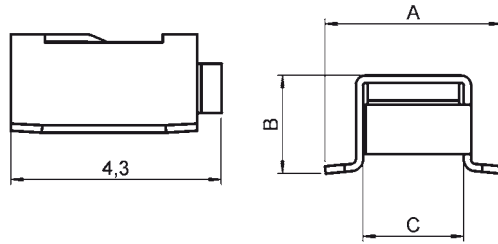
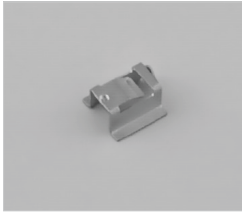

UMP TYPE	PART NUMBER	DIMENSIONS (MM)			FINISH	PACKAGING	REEL DIMENSIONS (MM)	ASSEMBLY INSTRUCTIONS
		A	B	C				
H2	R107 003 010	3.6	2	2.05	Gold	100 Pieces	180	M02
H3	R107 303 040	5.5	3	2.95				

### PIGTAILS

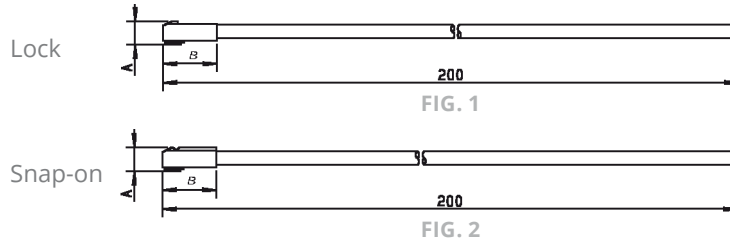
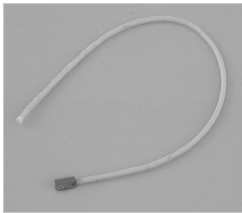

CABLE	CABLE GROUP	UMP TYPE	MATING TYPE	PART NUMBER	FIG.	DIMENSIONS (MM)		PACKAGING
						A	B	
C291 050 066	1/50/S	H2	Lock	R285 020 202	1	1.74	4	100 Pieces
			Snap-on	R285 020 212	2	1.65		
C291 170 017	2.6/50/S	H3	Lock	R285 020 401	1	2.84		

### BETWEEN SERIES CABLE ASSEMBLIES

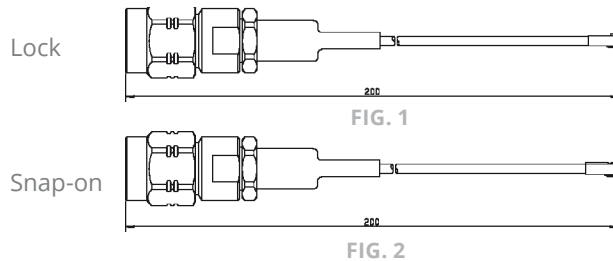

CABLE	CABLE GROUP	UMP TYPE	MATING TYPE	PART NUMBER	FIG.	SERIES	PACKAGING
C291 050 066	1/50/S	H2	Lock	R285 025 202	1	UMP/SMA	20 Pieces
			Snap-on	R285 025 212	2		
C291 170 017	2.6/50/S	H3	Lock	R285 025 401	1		

UMP

## TOOLS AND ACCESSORIES

### PRODUCTION LINE TEST ADAPTER: UMP - SMA FEMALE (TO BE USED WITH LOCK AND SNAP PIGTAILS ONLY)



PART NUMBER	CONNECTOR HEIGHT (MM)	PACKAGING
R107 009 901	H 2	Unit
R107 009 903	H 3	

For measurement and test purposes. Packaging: Unit

### EXTRACTION TOOL (FOR LOCK VERSION ONLY)



PHOTO 1



PHOTO 2

PART NUMBER	PHOTO	NOTE	TO DISCONNECT	PACKAGING
R282 867 020	1	Axial Disconnection	H 2	10 Pieces
R282 867 030	2	Lateral Disconnection	H 3	

The 2 disconnection tools allows axial and lateral disconnections depending on the occupied space on the PCB.

### INSERTION TOOL (OPTIONAL)



#### PART NUMBER

R282 203 020

This optional tool allows you a more precise connection in a limited space.

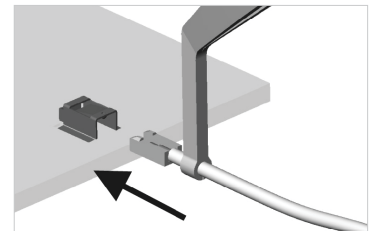

PACKAGING: UNIT

UMP

## ASSEMBLY INSTRUCTIONS

M02

### RECEPTACLE SOLDERING PATTERNS FOR COPLANAR LINE

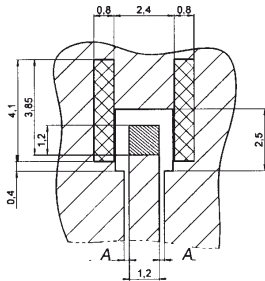

H2 Type Receptacle

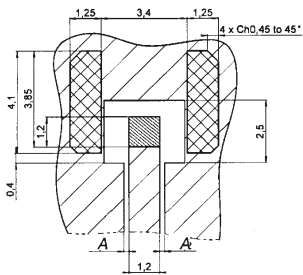

PART NUMBER
R107 003 010



H3 Type Receptacle

PART NUMBER
R107 303 040

PCB THICKNESS (MM)	COPLANAR LIGNE A (MM)
0.8	0.183
1.0	0.190
1.2	0.195
1.6	0.20

-  Gold over Nickel preferred for solder paste  
Gold can be replaced by tin lead (see test report SC2000.02.6587)
-  Gold over Nickel contact area free of any surface contaminant
-  Ground + varnish

### SMT NOZZLE

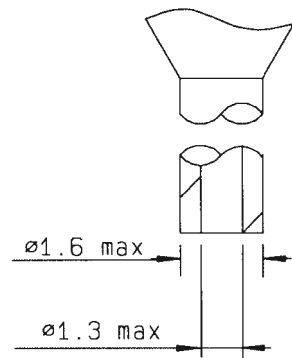

Automated pick and place machines use standard tooling to peel the antistatic film off. Sometimes the "A" dimension of this tool is shorter than the overall "B" width between the two legs of the receptacle. There is therefore a risk for the two legs being deformed while they pass through the tool during the suction operation. The user must then widen the "A" dimension of the peeling tool.

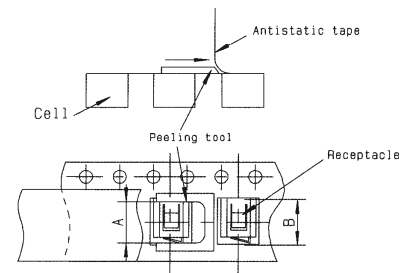

BR2

## INTERFACE

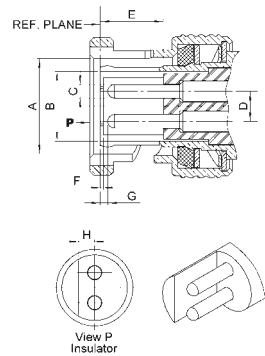

PLUG

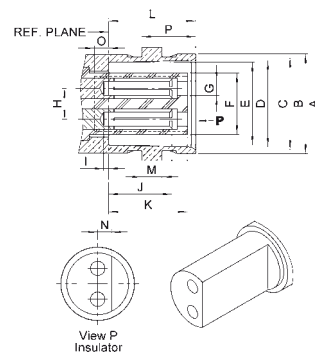

JACK

LETTER	MM		INCH	
	MIN	MAX	MIN	MAX
A DIA	9.78	9.91	.385	.390
B DIA	6.70	6.77	.264	.267
C DIA	1.31	1.36	.052	.054
D	2.95	3.05	.116	.120
E	7.6	7.9	.299	.311
F	-0.05	0.15	.002	.006
G	0.85	1.55	.033	.061
H	1.55	1.65	.061	.065

LETTER	MM		INCH	
	MIN	MAX	MIN	MAX
A DIA	10.93	11.09	.430	.437
B DIA	9.60	9.70	.378	.382
C DIA	8.79	9.04	.346	.356
D DIA	8.31	8.46	.327	.333
E DIA	8.09	8.15	.319	.321
F DIA	5.9	6.0	.232	.236
G DIA	1.4	1.45	.055	.057
H	2.95	3.05	.116	.120
I	-0.1	0.8	-.004	.031
J	5.3	5.7	.209	.224
K	7.05	7.35	.278	.289
L	8.36	8.46	.327	.335
M	1.91	2.06	.075	.081
N	1.45	1.55	.057	.061
O	0.35	0.85	.014	.033

## CHARACTERISTICS

Bayonet lock coupling with polarization

### ELECTRICAL AND ENVIRONMENTAL CHARACTERISTICS

<b>Dielectric Withstanding Voltage</b>	Between pins Between pins and body	1.500 volts RMS, 50 Hz
<b>Maximum Intensity</b>	3.5 Amp	
<b>Insulation Resistance</b>	Between pins Between pins and body	> 10 <sup>5</sup> MΩ
<b>Contact Resistance</b>	< 1 mΩ at 1 Amp	
<b>Capacity at 1 MHz</b>	Between pins Between pins and body	< 1.3 pF < 3.2 pF
<b>Frequency Range</b>	DC - 0.5 GHz	
<b>Temperature Range</b>	-40 +100 °C	

### MATERIALS

<b>All Metal Parts Under Stress</b>	Beryllium Copper
<b>Other Metal Parts</b>	Brass
<b>Insulators</b>	Polyamide and Diallylphthalate
<b>Gaskets</b>	Neoprene

BR2

## PLUGS AND JACKS

### STRAIGHT PLUGS FOR ARMOUR TWINAXIAL CABLE

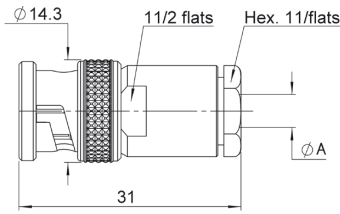

CABLE GROUP DIA.	PART NUMBER	DIMENSIONS (MM) A
Twinaxial 4	R605 004 000	4.6
Twinaxial 5	R605 005 000	5.6
Twinaxial 6	R605 006 000	6.6

### RIGHT ANGLE PLUG

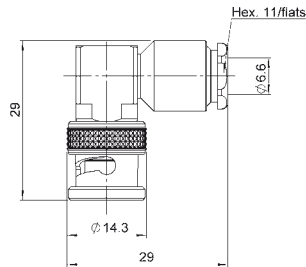

CABLE GROUP DIA.	PART NUMBER
Twinaxial 6	R605 156 000

### STRAIGHT JACKS

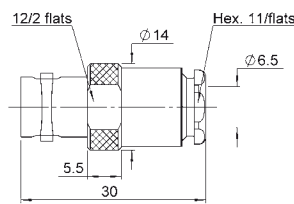

FIG. 1

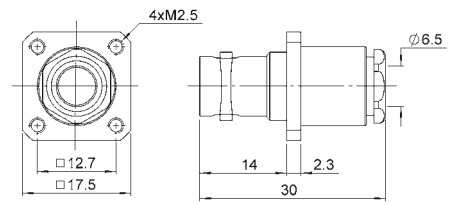

FIG. 2

CABLE GROUP DIA.	PART NUMBER	FIG.	PANEL DRILLING	NOTE
Twinaxial 6	R605 206 000	1	P01	-
	R605 256 000	2		Square Flange

BR2

## RECEPTACLES AND CAPS

### RECEPTACLES

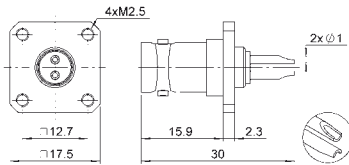

FIG. 1

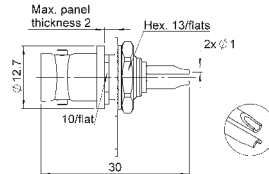

FIG. 2

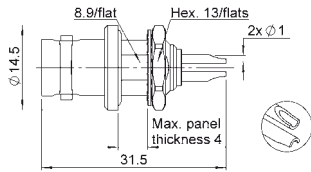
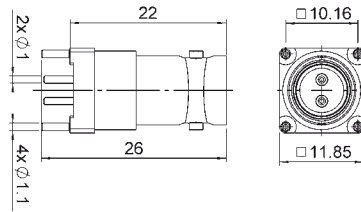

FIG. 3

PART NUMBER	FIG.	PANEL DRILLING	NOTE
R605 400 000	1	P02	Square Flange
R605 550 000	2	P04	Rear Fixing
R605 550 020			Front Mounting
R605 600 000	3	P05	Waterproof

### PCB RECEPTACLES



PART NUMBER	PANEL DRILLING
R605 440 000	P03

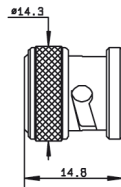

FIG. 1

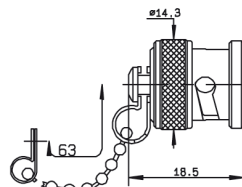

FIG. 2

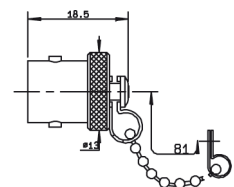
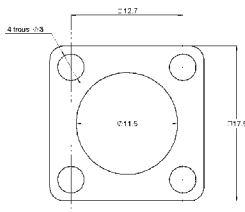

FIG. 3

PART NUMBER	FIG.	NOTE
R141 802 000	1	Male
R141 812 000	2	Male with Chain
R141 842 000	3	Female with Chain

BR2

**GASKET**



<b>PART NUMBER</b>
R280 503 000

**PANEL DRILLING**

P01

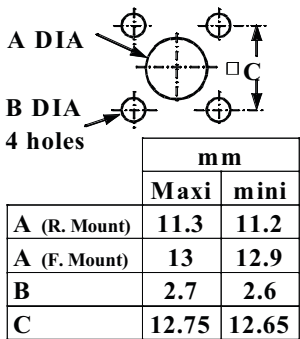

P02

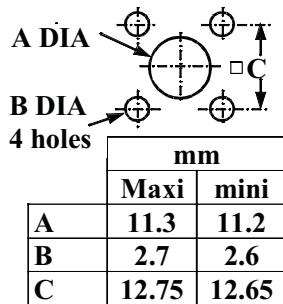

P03

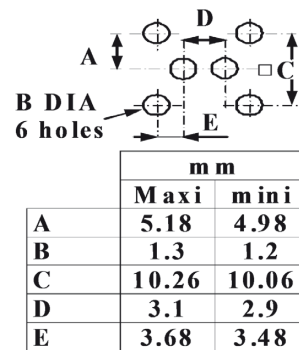

P04

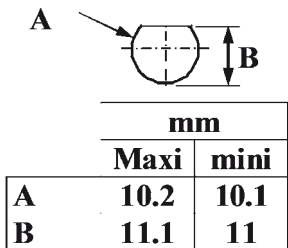

P05

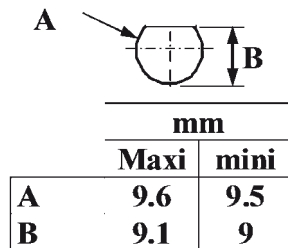



UHF

## INTERFACE

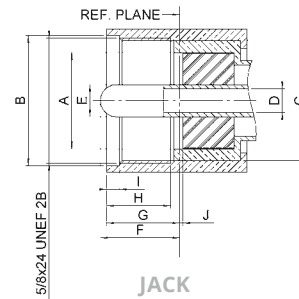
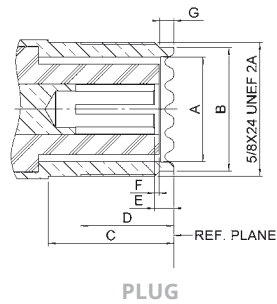

LETTER	MM		INCH	
	MIN	MAX	MIN	MAX
A DIA	11.56	12.22	.455	.481
B DIA	16.00	-	.630	-
C DIA	13.92	-	.548	-
D DIA	-	3.35	-	.132
E DIA	3.912	4.013	.154	.158
F	-	11.10	-	.437
G	-	9.91	-	.390
H	8.76	-	.335	-
I	1.19	4.27	.047	.168
J	0.00	-	.000	-

LETTER	MM		INCH	
	MIN	MAX	MIN	MAX
A DIA	11.56	12.22	.455	.481
B DIA	14.00	14.25	.551	.561
C	11.10	-	.437	-
D	7.87	-	.310	-
E	1.02	-	.040	-
F	0.03	-	.001	-
G	1.19	1.96	.047	.077

## CHARACTERISTICS

TEST / CHARACTERISTICS	VALUES / REMARKS
------------------------	------------------

## ELECTRICAL CHARACTERISTICS

Impedance	50Ω
Maximum Frequency Range	500 MHz
Test Voltage (At Sea Level)	2000 V rms - 50 Hz
Working Voltage (At Sea Level)	750 V
Insulation Resistance (Under 500 V)	≤ 5 GΩ
Contact Resistance	
• Center Contact	5 mΩ max
• Outer Contact	5 mΩ max

## MECHANICAL CHARACTERISTICS

Mating Cycles	500
---------------	-----

## ENVIRONMENTAL CHARACTERISTICS

Temperature Range	
• PTFE	-55°C to + 155°C
• Bakelite	-40°C to + 165°C
• Styramic	-40°C to + 70°C
Salt Spray	48 Hrs

## MATERIALS

Contacts and Interfaces	Heat Treated Beryllium Copper
Other Parts	Brass
Insulator	PTFE (T) - Bakelite (B) or Styramic (St.)
Gaskets	Neoprene or Silicone Rubber

All dimensions are given in mm.

UHF

**PLUGS, RECEPTACLES AND ADAPTER**  
**STRAIGHT PLUGS**

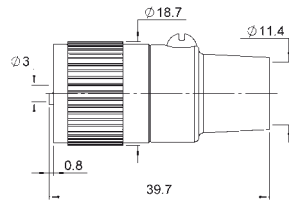

FIG. 1

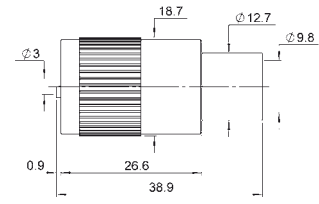

FIG. 2

CABLE GROUP	CABLE GROUP DIA.	PART NUMBER	FIG.	NOTE
RG213 / RG393 / RG11 / RG12 / RG144	10/50+75Ω	R155 003 000	1	Insulator: PTFE
		R155 005 000	2	

**RECEPTACLES**

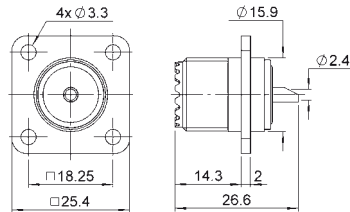

FIG. 1

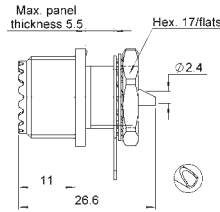

FIG. 2

PART NUMBER	FIG.	PANEL DRILLING	NOTE
R155 405 000	1	P01	Square Flange - Solder Pot - Insulator: PTFE
R155 560 000	2	P02	Bulkhead - Solder Pot - Insulator: PTFE