

**STRAIGHT PLUG CRIMP TYPE**

**R125.055.941**

**CABLE .141**

Series : SMA

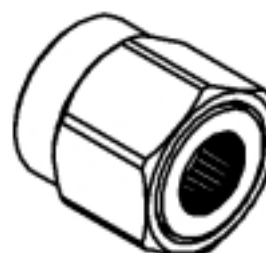
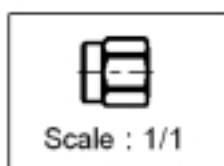
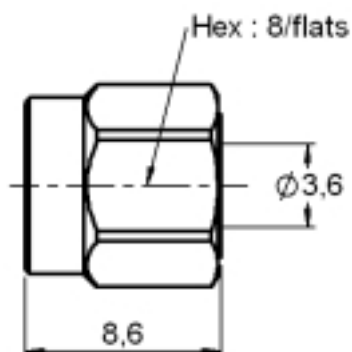

All dimensions are in mm.



COMPONENTS	MATERIALS	PLATINGS (µm)
BODY	STAINLESS STEEL	PASSIVATED .
CENTER CONTACT	BERYLLIUM COPPER	GOLD 1.3 OVER NICKEL 2
OUTER CONTACT	-	-
INSULATOR	PTFE	-
GASKET	SILICONE RUBBER	-
OTHERS PARTS	STAINLESS STEEL	PASSIVATED .
-	-	-
-	-	-

Issue : 0039 A

In the effort to improve our products, we reserve the right to make changes judged to be necessary.



**STRAIGHT PLUG CRIMP TYPE**

**R125.055.941**

**CABLE .141**

Series : SMA

**PACKAGING**

Standard	Unit	Other
<b>100</b>	<b>'W' option</b>	<b>Contact us</b>

**SPECIFICATION**

**CABLE ASSEMBLY**

**ELECTRICAL CHARACTERISTICS**

Stripping	a	b	c	d	e	f
mm	2.16	0.00	0.00	0.00	0.00	0.00

Impedance		<b>50</b>	$\Omega$
Frequency		<b>0-26.5</b>	GHz
VSWR	<b>1.05 +</b>	<b>0.010</b>	x F(GHz) Maxi
Insertion loss		<b>0.03</b>	$\sqrt{F}$ (GHz) dB Maxi
RF leakage	- (	<b>60</b>	- F(GHz)) dB mini
Voltage rating		<b>500</b>	Veff Maxi
Dielectric withstanding voltage		<b>1000</b>	Veff mini
Insulation resistance		<b>5000</b>	M $\Omega$ mini

Assembly instruction :

Recommended cable(s)  
RG 402  
KS 2

Cable retention

- pull off **270** N mini
- torque **NA** N.cm

**MECHANICAL CHARACTERISTICS**

**TOOLING**

Center contact retention			
Axial force – Mating end		<b>15</b>	N mini
Axial force – Opposite end		<b>15</b>	N mini
Torque		<b>NA</b>	N.cm mini

Part Number	Description	Hexagon
.	.	.
R282.286.000	CRIMPING TOOL	-
R282.711.000	GUIDE	
R282.053.000	STRIPPING TOOL	
R282.066.000	POINTER GAUGE	
R282.700.010	POSITIONER	

Recommended torque			
Mating		<b>100</b>	N.cm
Panel nut		<b>NA</b>	N.cm
Clamp nut		<b>NA</b>	N.cm
A/F clamp nut		<b>0.000</b>	mm

**OTHERS CHARACTERISTICS**

Mating life		<b>500</b>	Cycles mini
Weight		<b>2.700</b>	g

**ENVIRONMENTAL**

Operating temperature		<b>-65/+105</b>	$^{\circ}$ C
Hermetic seal		<b>NA</b>	Atm.cm3/s
Panel leakage		<b>NA</b>	

Issue : 0039 A

In the effort to improve our products, we reserve the right to make changes judged to be necessary.



**STRAIGHT PLUG CRIMP TYPE**

**R125.055.941**

**CABLE .141**

Series : SMA

**COMPONENTS**

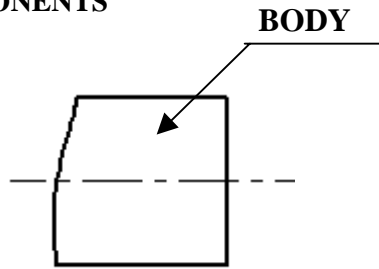

**STIPPING DIMENSIONS**

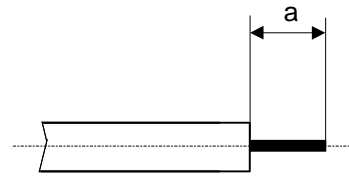

1

- Strip the cable with the cable stripping tool
- Trim the cable inner conductor with the trimmer.

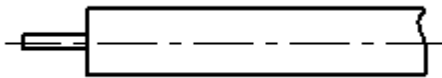

3

- Insert the connector and the cable on the crimping tool with guide and positioner.
- A pneumatic crimping tool exist too that can be used

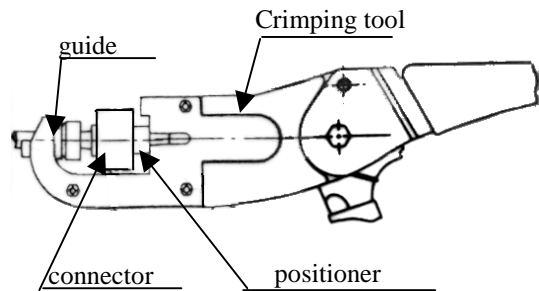

2

- Slide connector onto the cable

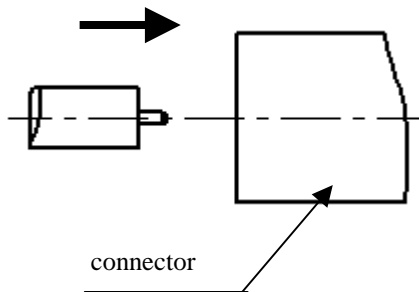

4

- Press the connector on the cable.

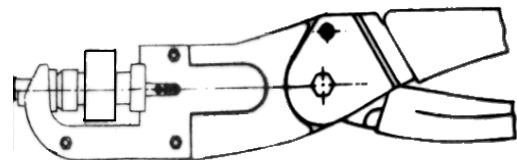

Issue : 0039 A

In the effort to improve our products, we reserve the right to make changes judged to be necessary.

