

R2CT™ Series

R2CT

	Pages
Introduction	9-4
Characteristics	9-5
Product range	
R2CT™ standard plug kit	9-6
R2CT™ mini short plug kit	9-7
R2CT™ standard receptacle	9-8
R2CT™ receptacle with LC adaptor	9-9
R2CT™ adaptor N-RJ45	9-9
R2CT™ pre-mounted optical cable assemblies	9-10
R2CT™ pre-mounted on RJ45 cable assemblies	9-10
Patch cords	9-10

INTRODUCTION

R2CT™: RADIAL 2 CONNECTORS TO TRANSCEIVER



« The most flexible outdoor interconnection solution »

The R2CT™ (Trademark of Radiall) connection system is the most flexible outdoor interconnection solution that meets the needs of telecommunication OEMs and operators for fiber-to-the-antenna (FTTA) and similar multisignal applications in the field conditions. At the panel front of the Remote Radio Head (RRH) and Unit (RRU) equipment, the R2CT™ provides a simple and protected low-cost waterproof and sealed connection. Designed firstly for optical links using SFP transceivers and duplex LC-terminated fiber-optic cable, this very flexible connector is also useful for electrical links.

BENEFITS & FEATURES

• Flexible and Modular

- Kit assembles in the field over existing optical patch cords
- Compatible with any standard optical LC field cable assembly
- Compatible with any standard SFP transceiver
- Reusable allowing cables and transceivers to be easily changed in the field, including front-panel swapping of transceivers
- R2CT™ connection system can easily be used for other Ethernet and multisignal applications: compatible with RJ45 patch cords and USB connections

• Robust and Easy to Install

- Double bayonet locking system ensures mechanical connection, allowing a toolless hand-tightened connection - *Patent pending*
- Kit assembles without tools
- Designed to withstand climatic working conditions of outdoor field applications
- Plug assembly includes a protection cap that can be used for pulling cable

• Mechanical and Environmental Protection

- Waterproof
- Dustproof
- Important tensile strength

• Low Cost

APPLICATIONS

- Fiber To The Antenna
- Outdoor telecom
- Harsh environments connection
- Industrial connection



R2CT™ connector has been designed to fulfill the qualification requirements of IEC 61300 standard (for fiber optic interconnection devices)

MECHANICAL CHARACTERISTICS

Cable retention	200N
Mating endurance	100 mating cycles minimum

ENVIRONMENTAL CHARACTERISTICS

Ingress Protection class	IP65 or IP67 optionally (*)
Operating temperature	-40°C / +85°C
Storage temperature	-40°C / +85°C
Salt mist	IEC 61300-2-26 passed
Vibrations	IEC 61300-2-1 passed

(*): IP65 for full assembly by kit in the field over existing patch cords.

PRODUCT RANGE

R2CT™ solution is available as a component (Plug Kit) to fit in the field on any conventional LC optical connector or as a complete cable assembly.

For electrical links such as RJ45 connections, a short version of the R2CT™ Plug Kit has been developed with reduced overall dimensions.

R2CT™ STANDARD PLUG KIT

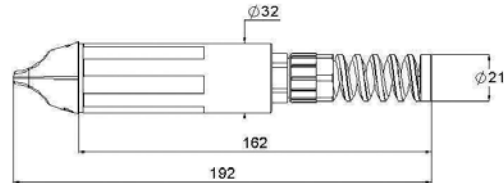

Part number	Description	Packaging
R2CT 115 000	Plug connector only; no patch cord	unitary in plastic bag with assembly note

The R2CT™ Plug Kit is adapted to all types of optical cable assemblies with simplex or duplex LC connectors and 5 to 7 mm diameter MultiMode or SingleMode field cable – other diameters are available on request.

To guarantee proper operation when the R2CT™ Plug Kit is assembled over existing optical patch cords, the following fan-out dimensions should be observed:

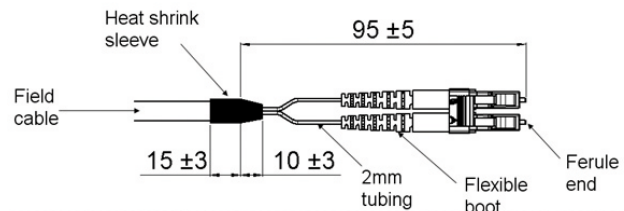

R2CT™ MINI SHORT PLUG KIT - DEDICATED TO ELECTRICAL LINKS (RJ45)

The R2CT™ mini short Plug Kit can fit with any type of electrical or Ethernet RJ45 cables with diameters from 5 to 7 mm – (for other diameters please contact your Radiall sales team).

R2CT™ mini short Plug Kit connector exists in IP67 version or in IP65 version with split gasket for full assembly in the field.

It is delivered with a pulling nose which protects the connector interface and can include a disconnection clip to disconnect the RJ45 connector of its socket.

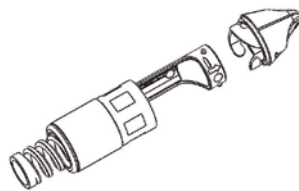
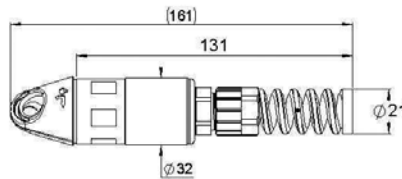

Figure 1

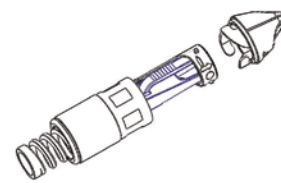

Figure 2

Part Number	Figure	Description	Packaging
R2CT 127 000	1	Kit IP67 protection Plug connector only; no patch cord	unitary in plastic bag with assembly note
R2CT 127 001	2	Kit IP67 protection with disconnection clip Plug connector only; no patch cord	
R2CT 125 000		Kit IP65 protection with disconnection clip Plug connector only; no patch cord	

PRODUCT RANGE

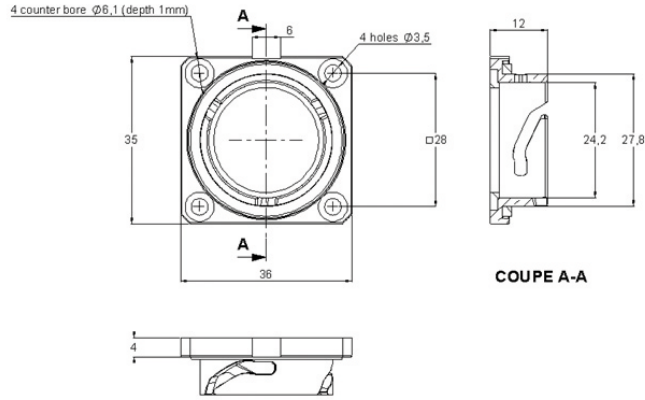

R2CT™ STANDARD RECEPTACLE

Fixed to the panel of the equipment by four screws, the R2CT™ standard receptacle allows an easy access to connect the signal: to SFP transceivers for optical links or to RJ45 socket for Ethernet links.

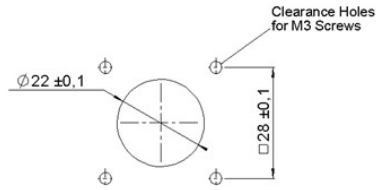

The R2CT™ receptacle is supplied with the protection cap installed.

Two possible configurations: red vinyl cap (protection IP65) or aluminium protection cap (IP67).

	Part Number	Description	Panel cut out
	R2CT 105 000	Receptacle with Red Vinyl Protection Cap	
	R2CT 107 000	Receptacle with Metal Protection Cap	

R2CT™ RECEPTACLE WITH LC ADAPTOR

A variation of the R2CT™ receptacle has been developed to include a LC adaptor SingleMode version to allow the R2CT™ interface to be used for RRU and RRH of first generation with SFP transceiver inside the equipment.

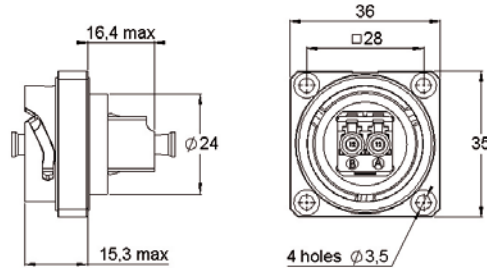

Part Number	Panel cut out
R2CT 107 200	

R2CT™ ADAPTOR N-RJ45

For needs of measurement and control of the RRU and RRH equipments in FTTA applications, a specific version of R2CT™ has been developed to adapt RJ45 connection signal to a coaxial signal with N interface.

Picture	Figure	Part Number
		R2CT 135 000

PRODUCT RANGE

R2CT™ PRE-MOUNTED OPTICAL CABLE ASSEMBLIES

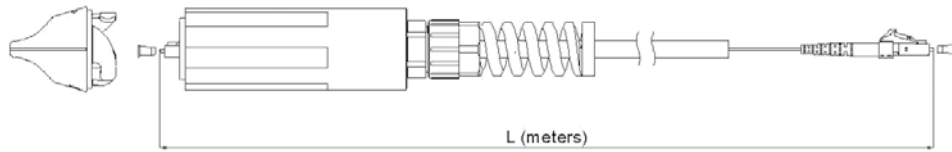

Any configuration for a cable assembly with R2CT™ is available on demand:

- Field cables with diameters of 5 to 7 mm on standard – other cable sizes on request
- Standard LC connectors (R2CT™ side)
- Any possibility of optical connectors on the opposite side (LC, SC, FC, ST, etc...)
- Simplex or duplex connectors
- MultiMode (50/125 or 62.5/125 on request) or SingleMode (9/125) cable
- Polishing/finishing: PC or APC

OPTICAL CHARACTERISTICS

Insertion Loss (mated with reference plug) (@1310 & 1550 nm)	0.5 dB max (method 6)
Return Loss (@1310 & 1550 nm)	RL > 45 dB (method 7)

For more detailed information: please refer to the “Cable assemblies” section of this catalogue.

R2CT™ PRE-MOUNTED ON RJ45 CABLE ASSEMBLIES



R2CT™ cable assemblies with RJ45 connectors on 5 to 7 mm diameter cable are available in any length on demand. Other cable diameters are available on request.

PATCH CORDS



Radiall can also provide any configuration of LC optical patch cords or RJ45 patch cords for use with the R2CT™ Plug Kit.

For more detailed information: please refer to the “Cable assemblies” section of this catalogue.



AEROSPACE



AUTOMOTIVE



DEFENSE



INDUSTRIAL



INSTRUMENTATION



MEDICAL



SPACE



TELECOM

EUROPE

France - RADIALL S.A.

101, Rue Ph. Hoffmann
93116 ROSNY sous BOIS (Paris)
Tel.: +33 1 49 35 35 35 - Fax: +33 1 48 54 63 63
E-Mail: info@radiall.com

Finland - RADIALL SF

P.O. Box 202 - 90101 OULU
Tel.: +358 407 522 412
E-Mail: infofi@radiall.com

Germany - RADIALL GmbH

Carl-Zeiss Str. 10 Postfach 200143
D63307 - RÖDERMARK (Frankfurt)
Tel.: +49 60 74 91 07 0 - Fax: +49 60 74 91 07 70
E-Mail: infode@radiall.com

Italy - RADIALL Elettronica S.R.L.

Via Concordia, 5 - 20090 ASSAGO MILANO
Tel.: +39 02 48 85 121 - Fax: +39 02 48 84 30 18
E-Mail: infoit@radiall.com
Regional office: Roma

Netherlands - RADIALL B.V.

Hogebrikerweg 15b - 3871 KM HOEVELAKEN
Tel.: +31 33 253 40 09 - Fax: +31 33 253 45 12
E-Mail: infonl@radiall.com

Sweden - RADIALL A.B.

Sjöängsvägen 2 - SE-192 72 SOLLENTUNA (Stockholm)
Tel.: +46 844 434 10 - Fax: +46 875 449 16
E-Mail: infose@radiall.com

U.K. - RADIALL Ltd.

Ground Floor, 6 The Grand Union Office Park,
Packet Boat Lane
UXBRIDGE Middlesex UB8 2GH (London)
Tel.: +44 1895 425 000 - Fax: +44 1895 425 010
E-Mail: infouk@radiall.com

NORTH AMERICA

USA - RADIALL USA, Inc.

6825 West Galveston Street
CHANDLER, Arizona 85226
Tel.: +1 480 682 9400 - Fax: +1 480 682 9403
E-Mail: infousa@radiall.com

ALSO REPRESENTED IN

Australia	Hungary	Poland
Austria	Indonesia	Russia
Belgium	Israel	Singapore
Brazil	Korea	Spain
Czech Republic	Latvia	Switzerland
Denmark	Lithuania	Taiwan
Estonia	Malaysia	Thailand
Greece	Norway	Vietnam
	Philippines	South Africa

For the above countries, please contact the local agent or RADIALL at info@radiall.com

ASIA

China - SHANGHAI RADIALL Electronic Co., Ltd.

N° 390 Yong He Road 200072 - SHANGHAI
Tel.: +86 21 66 52 37 88 - Fax: +86 21 66 52 11 77
E-Mail: infosh@radiall.com

Japan - NIHON RADIALL

Shibuya-ku Ebisu 1-5-2, Kougetsu Bldg 405
TOKYO 150-0013
Tel.: +81 3 3440 6241 - Fax: +81 3 3440 6242
E-Mail: infojp@radiall.com

Hong Kong - RADIALL Electronics Ltd.

Flat D, 6/F, Ford Glory Plaza,
37-39 Wing Hong Street
Cheung Sha Wan
KOWLOON HONG KONG
Tel.: +852-2959-3833 - Fax: +852-2959-2636
E-Mail: infohk@radiall.com

India - RADIALL India Pvt. Ltd.

25 D, II Phase, Peenya Industrial Area
BANGALORE 560058
Tel.: +91 80 83 95 271 - Fax: +91 80 83 97 228
E-Mail: infoin@radiall.com

